

MC_Rack Manual



Information in this document is subject to change without notice.

No part of this document may be reproduced or transmitted without the express written permission of Multi Channel Systems MCS GmbH.

While every precaution has been taken in the preparation of this document, the publisher and the author assume no responsibility for errors or omissions, or for damages resulting from the use of information contained in this document or from the use of programs and source code that may accompany it. In no event shall the publisher and the author be liable for any loss of profit or any other commercial damage caused or alleged to have been caused directly or indirectly by this document.

© 2016 Multi Channel Systems MCS GmbH. All rights reserved.

Printed: 17. 02. 2013

Multi Channel Systems

MCS GmbH

Aspenhaustraße 21

72770 Reutlingen

Germany

Fon +49-71 21-90 92 5 - 0

Fax +49-71 21-90 92 5 -11

info@multichannelsystems.com

www.multichannelsystems.com

Microsoft and Windows are registered trademarks of Microsoft Corporation. Products that are referred to in this document may be either trademarks and/or registered trademarks of their respective holders and should be noted as such. The publisher and the author make no claim to these trademark.

Table of Contents

Introduction	1
About this Manual	1
Terms of Use	2
Limitation of Liability	2
Important Safety Advice	2
First Use of MC_Rack	3
Welcome to MC_Rack	3
Installing MC_Rack	4
Step by Step Tutorial	7
Using the Step by Step Tutorial	7
Monitoring and Recording Activity	8
Starting MC_Rack	8
Defining the Data Source	9
Advanced Configuration	24
Adding a Data Source	32
Channel Tool	35
Monitoring Activity Continuously	36
Recording Data	42
Starting Data Acquisition and Recording	44
Monitoring and Recording Triggered Activity	45
Triggering MC_Rack on the Stimulus	45
Monitoring Triggered Activity	47
Recording Triggered Data	48
MEA2100-System	51
MEA2100-System	51
Wireless-System	64
Wireless System	64
MC_Rack Features	67
About MC_Rack Features	67
Data Acquisition Settings	67
Data Source Setup	67
Defining Hardware Settings	83
Channel Tool	86
Grouping Multitrode Channels	87
Simulation Mode	87
Data Streams and Channels	90
Data Stream Types	90
Channel Selection	91
Continuous and Triggered Data	92
Averaged Data	94
Digital Data and Binary Code	96

Recorder	97
Recording Data	97
Generating Data Files	99
Replayer	101
Loading a Data File	101
File Specifications	102
Replaying Data	102
Displaying Data	104
Display Types	104
Setting up a Display Layout	104
Display Settings	106
Peak Detection	107
Customizing a Display	109
Displaying a Background Picture	109
ASCII Export of Waveforms	110
Data Display (for Monitoring Raw Data)	111
Plot Types	111
Trace Plot	111
Overlay Plot	111
Raster Plot	112
Digital Display (for Monitoring TTL Inputs)	114
Displaying Digital Data	114
Numeric Display	114
Trigger Detector	115
Using the Manual Trigger	115
Triggering MC_Rack	117
Triggering on TTL Pulses	117
Triggering on Biological Signals	119
Triggering on Extracted Parameters	120
Time Based Trigger	120
Automatic Feedback	122
Digital Output	122
Real-time Feedback	123
Real-time Feedback	123
Filtering Data	134
Filtering Data	134
Filter Characteristics	137
Filtering and Sampling Rate	138
Downsampling	140
Spike Sorter	142
Spike Detection Methods	142
Detecting Spikes by a Threshold	143
Detecting Spikes by Waveform	143
Spike Cutouts	144
Spike Sorting	145
Burst Analysis	147
Analyzing Data	152
Analyzing Data	152
Time-Interval Based Analyzer	153
Event-Based Spike Analyzer	158

Parameter + Spike Analyzer Display	158
Plot Types	158
Trace Plot	158
False Color Maps	159
False Color vs. Time (Plot)	159
False Color Plot	159
Number Plot	160
Parameter/Digital Display Tools + Settings	161
ASCII Export of Extracted Parameters	164
Image Capture	164
Averager	165
Averaging Data Sweeps	165
Sound Output	166
Sound Output with MC_Card	166
Audio Out with USB-ME Data Acquisition	167
Data Export	169
About Data Export	169
Graphs for Presentations	171
Low Resolution Pics (Screen Shots)	171
Working with Graphics Programs	171
Extracting Spikes	172
Spike Sorting	172
General Spike Analysis	173
Analyzing Cardiac Signals	173
Wave Propagation	173
Waveform Shape and QT Interval	174
Extracting Parameters	174
Exporting Parameter Streams to Excel	174
MC_DataTool	174
About MC_DataTool	174
Troubleshooting	175
Technical Support	175
Error Messages	176
Computer Performance	176
Replayer	177
Recorder	178
Running more than one instance of MC_Rack in parallel	178
Hardware Errors	178
Data is not Written to Hard Disk	179
Channels Not Visible or Available	179
Appendix	184
Glossary	183
Index	187

1 Introduction

1.1 About this Manual

This manual comprises all important information about MC_Rack. It is assumed that you have already a basic understanding of technical and software terms, but no special skills are required to read this manual.

Start practicing with the **Tutorial**. We offer you the opportunity of Learning by Doing, which means that you start directly with practicing without much reading beforehand. We suggest that you start MC_Rack and then follow the Guided Tour step by step, either using the integrated Help or the printed manual. Just decide what you like to do, read all necessary information in short and put this information directly into practice.

If you need further information or like to review specific topics as an already experienced user, please confer to the "MC_Rack Features" part, where you can find more precise information about all topics.

The **printed manual** and **Help** are basically the same, so it is up to you which one you will use. The Help offers you the advantage of scrolling through the text in a non-linear fashion, picking up all information you need, especially if you use the **Index**, and the **Search** function. If you are going to read larger text passages, however, you may prefer the printed manual.

The device and the software are part of an ongoing developmental process. Please understand that the provided documentation is not always up to date. The **latest information** can be found in the **Help**.

1.2 Terms of Use

You are free to use MC_Rack for its intended purpose. You agree that you will not decompile, reverse engineer, or otherwise attempt to discover the source code of the software.

1.3 Limitation of Liability

Multi Channel Systems MCS GmbH makes no guarantee as to the accuracy of any and all tests and data generated by the use the MC_Rack software. It is up to the user to use good laboratory practice to establish the validity of his findings.

To the maximum extent permitted by applicable law, in no event shall Multi Channel Systems MCS GmbH or its suppliers be liable for any special, incidental, indirect, or consequential damages whatsoever (including, without limitation, injuries, damages for data loss, loss of business profits, business interruption, loss of business information, or any other pecuniary loss) arising out of the use of or inability to use MC_Rack or the provision of or failure to provide Support Services, even if Multi Channel Systems MCS GmbH has been advised of the possibility of such damages.

1.4 Important Safety Advice



Warning: Make sure to read the following advices prior to install or to use MC_Rack. If you do not fulfill all requirements stated below, this may lead to malfunctions or breakage of connected hardware, or even fatal injuries. Obey always the rules of local regulations and laws. Only qualified personnel should be allowed to perform laboratory work. Work according to good laboratory practice to obtain best results and to minimize risks. Make always sure to validate your findings. Prepare backup copies on a regular basis to avoid data loss.

- The operator is obliged to ensure that MC_Rack is only be used for its intended purpose and that it is only used by qualified personnel.
- MC_Rack is **not** intended for medical uses and **must not** be used on humans, especially not for uses that could impair health.

2 First Use of MC_Rack

2.1 Welcome to MC_Rack

Please read the following paragraphs to understand the general idea behind the MC_Rack program before going on with the tutorial or application examples.

MC_Rack is a data acquisition and analysis software. Combined with the hardware, for example MEA2100-System, (USB-) ME-Systems or (USB-) MEA-Systems, it forms a complete data acquisition system for measuring extracellular activities of excitable cells, *in vitro* and *in vivo*. It has been developed especially for use with the (USB-) ME- and the (USB-) MEA-System, but is also ideally suited to work with other experimental setups.

Together with the data acquisition device, MC_Rack fully replaces a complete hardware set for data acquisition. For example, you do not need an oscilloscope, a filter, or a spike detector device anymore, because all these functions are integral parts of the software. You set up a virtual instrument rack, which is comfortable, easy to use, and saves space on your workbench.

The main power of MC_Rack is its great **flexibility**. You can combine various virtual instruments according to your experimental setup. You can decide about the fate of each single **data stream separately**. It is up to you, which data streams are **displayed** on the screen, which are **saved**, which are **analyzed**, and so on. This concept saves disk space and computer performance and makes handling of up to **256 channels** with up to **50 kHz sampling rate** easy. A status bar informs you on the actual performance of your computer when you record or replay data.

Please note that the high flexibility of MC_Rack makes a complex configuration of the software necessary. As a fresh user of MC_Rack, this may present some difficulties to you. But the straightforward user interface will soon make you feel comfortable with the general concept and learn to appreciate the advantages of the system. This documentation tries to help you on your way.

It is very important to note, that **all virtual instruments** in your rack work **independently** from each other. As a consequence, they have to be **configured separately**. For example, you have to select the input streams for each instrument separately.

Generally, you will arrange the virtual instruments in your rack in a **hierarchical order**. The selected data streams flow from your **data acquisition** or from the **Replayer** (recorded data) into the virtual instrument highest in the hierarchy. Similar to a production line in a plant, this instrument picks up only those channels from the data streams that you have **assigned** to it. It processes this data and produces an output stream that is lead to the virtual instrument(s) next in the hierarchy, and so on. When you build a rack, make yourself clear, which data streams flow to which instrument and what output you should expect. If you change the selection of channels for a virtual instrument, you may have to adjust the selection for instruments that depend on its output as well. If you have not specified an input for a tool, an error message will inform you.

In MC_Rack, the rack you use to record and analyze data online and offline, and the data files are as a matter of principle independent from each other. You can save and **reuse a rack** for several experiments and generate separate data files. You can then load the generated data file with another rack for further offline analysis later.

The **MC_Rack help** is divided into the following **main sections**:

- **Step by Step Tutorial**: The tutorial introduces **basic MC_Rack features** for directly setting up a basic experiment.
- **MEA (In Vitro) Application Examples** (please see separate document): Main MC_Rack features are explained **in detail** on the basis of **typical applications** and **demo data files**. We recommend to study especially the applications that you are interested in before starting an experiment, so that you learn about the possibilities and how to configure MC_Rack for different applications. This section is more detailed than the tutorial. Also, it is easier to understand the software features when playing around with demo data.
- **MC_Rack Features**: All MC_Rack features are explained **in detail**. This section is especially useful if you want to learn more about a specific software feature.
- **Data Export**: Summarizes the export options of MC_Rack and MC_DataTool and provides recommendations for third party programs for offline data analysis.
- **Troubleshooting**: Lists typical minor problems that might occur during operation and gives hints how to solve them.

2.2 Installing MC_Rack

The data acquisition computer with the data acquisition device, for example MEA2100-Systems or USB-MEA256, comes preinstalled and preconfigured by MCS for a flawless operation. You should contact your local retailer for assistance if you want to install additional hard- or software, or if you want to replace the computer, as incompatibilities of hardware components or software settings with MC_Rack may occur.

Caution: You have acquired a high performance data acquisition and analysis computer. Do not modify the system, do not install new hard- or software, or another operating system without asking MCS or your local retailer for advice. Especially do not install virus scanners or firewalls because these programs are known to interfere with the data transfer to the hard disk. MCS cannot guarantee that a modified system is fully operational. Even data loss may occur.

System requirements

Software:

One of the following Microsoft Windows ® operating systems is required: **Windows 10, 8.1, Windows 7, Vista, or XP (English and German versions supported)** with the NT file system (**NTFS**). Other language versions may lead to software errors.

Hardware:

The **MEA2100-Systems**. (Not required for offline analysis or demo mode). The MEA2100-System consists of two main devices: The interface board with integrated signal processor and the headstage equipped with amplifier, A / D converter and stimulus generator. It is possible to connect one headstage only or two headstages to one interface board. If you are dealing with two headstages, each headstage can be operated independently by opening the data acquisition software MC_Rack for each headstage separately. Recording from up to 240 channels is possible.

The **USB-ME-Systems** or the **USB-MEA-Systems**. (Not required for offline analysis or demo mode). These systems are equipped with an internal data acquisition. The analog input signals from up to 256 channels are acquired and digitized by the systems and the digital electrode signals are transmitted to the connected computer via universal serial bus (High Speed USB 2.0).

The data acquisition board **MC_Card**. (Not required for offline analysis or demo mode). If no MC_Card is present, MC_Rack opens in a simulation mode. A computer with low performance may lead to performance limits more often; therefore, MCS recommends an up-to-date computer.

Please note that there are sometimes hardware incompatibilities of the data acquisition and computer components; or that an inappropriate computer power supply may lead to artifact signals. Please contact your local retailer for more information on recommended computer hardware.

Important: You need to have installed the latest driver to operate the data acquisition device, which is automatically installed with MC_Rack. The installation may be invalid if the data acquisition device does not respond. Please contact Multi Channel Systems or your local retailer in this case.

Recommended operating system settings

The following automatic services of the Windows operating system interfere with the data storage on the hard disk and can lead to severe performance limits in MC_Rack. These routines were designed for use on office computers, but are not very useful for a data acquisition computer.

- Turn off automatic **Windows Update**.
- **Windows Indexing Service** deselected for all local disks.
- **Optimize hard disk when idle** (automatic disk fragmentation) turn off.
- It is also not recommended to run any applications in the background when using MC_Rack. Remove all applications from the **Autostart** folder.
- Be careful when using a **Virus Scanner**. These programs are known to disturb MC_Rack, and even data loss may occur.
- When using an **USB-ME-System** or an **USB-MEA-System** it is recommended to connect a high performance computer with a separate hard disc for program files and data storage. The provided possibility to use up to 256 channels with a sample rate of up to 40 kHz needs high memory capacity. Please remove data and defragment the hard disc regularly to ensure optimal performance.



Warning: The operating system settings of the data acquisition computer were preconfigured by MCS and should not be changed by the user. Changing these settings can lead to program instabilities and data loss.

Switching on the connected computer

(Applicable only if you use a data acquisition computer from Multi Channel Systems.)

1. Power up the connected computer and wait until it is ready. The **Login dialog box** appears.
2. Enter "**mcs**" both as the **user name** and as the **user password**. You do not have to enter an administrator password. (You may change the passwords later, of course.) The Windows desktop is displayed.

Installing the software

Please check the system requirements before you install the software. MCS cannot guarantee that the software works properly if these requirements are not fulfilled.

Important: Please make sure that you have full control over your computer as an **administrator**. Otherwise, it is possible that the installed software does not work properly.

1. Double-click **Setup.exe** on the installation volume. The installation assistant will show up and guide you through the installation procedure.
2. Follow the instructions of the installation assistant. The hardware driver and MC_Rack are installed (or updated) automatically.

3 Step by Step Tutorial

3.1 Using the Step by Step Tutorial

In the following tutorial, you will set up virtual racks for different applications from scratch. The goal is that you learn about MC_Rack features by doing. The racks are quite simple to give you an idea of the software's philosophy and how things work. All racks described in the tutorial are also available on the installation volume. So, if you prefer to start with a preconfigured rack, you can load the rack of interest first, and then go through this tutorial to see how to adapt the rack's settings and parameters to your needs, but we recommend that you take a bit time to build it yourself to learn the principle of operation.

Both racks discussed in the Step by Step Tutorial are basic racks for monitoring and recording data. The only difference is, that Monitoring and Recording Activity Continuously describes how to monitor and record activity continuously (generally used for spontaneous activity). Monitoring and Recording Triggered Activity describes how to monitor and record activity triggered by an event, that is, for evoked responses, for example, in an LTP experiment. All important information is repeated in each section, so you may freely choose the rack that is suitable for your application without missing information.

The difference to the MEA application examples (see separate document) is that the racks that we set up in this tutorial can be used directly in a real experiment. Without demo data, they may appear somehow a bit abstract. If you are new to the extracellular recording technique and want to get an impression how MC_Rack works and how signals can look like, you may prefer to have a look at the MEA application examples and demo racks first. Also, in the MEA application examples section, more advanced MC_Rack features are explained in detail and very near to the application.

You will find a list and a short description of all sample racks in the MC_Rack Sample Racks topic.

The MEA Signal Generator

The MEA Signal Generator **MEA-SG** is a convenient tool for MEA-Systems first time users. The device has the same dimensions and connector layout as a 60-channel MEA chip and is compatible with all MEA1060 amplifier types and with the MEA2100-60 / MEA2100-2x60-Systems. The **MEA-SG** can produce sine waves, or replay a variety of biological signals. These signals are fed into the MEA amplifier as analog signals. With this artificial data, you are able to test the functionality of the hardware and software system, without the need for a biological sample. Please use the 256MEA-SG for the USB-MEA256-System and the 120MEA-SG for MEA2100-120-Systems.

3.2 Monitoring and Recording Activity

3.2.1 Starting MC_Rack

- Double-click the **MC_Rack** icon or select **MC_Rack** from the **Start** menu. The program starts. One window opens automatically. This is your **virtual rack** configuration, which is blank after program start. Therefore, most commands and buttons are unavailable. You can choose from various software features, so-called virtual instruments, and assemble the virtual rack according to your specific application. You will learn in this tutorial how to set up racks for some typical applications.

MC_Rack main window (empty)

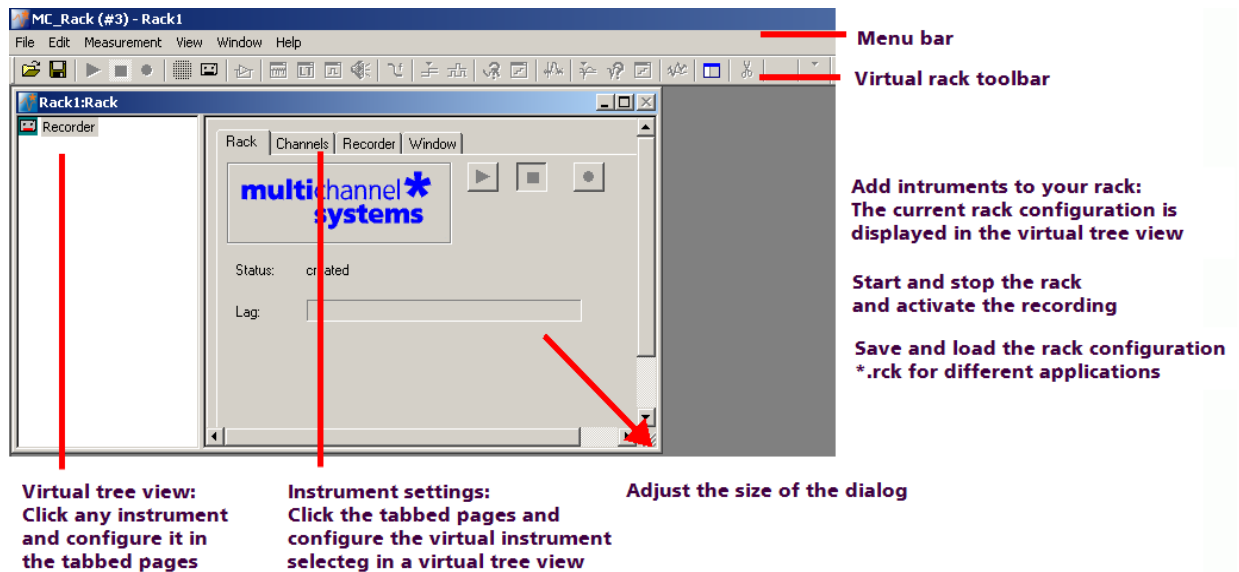

The virtual rack

The title bar shows the file name of the **virtual rack** (the default name before saving the rack under a custom name is **Rack1**). The white pane on the left of the virtual rack window holds the **virtual rack tree view pane**, where all virtual instruments that are part of this rack are represented by icons and (customizable) individual instrument names.

After program start, the virtual rack is almost empty. It holds only a single virtual instrument the **Recorder**, represented by a small cassette player icon. The context-sensitive grey pane on the right shows the **virtual instrument settings** (organized in tab pages) of the virtual instrument that is selected (highlighted in blue) in the virtual rack tree view pane on the left. If you have added more instruments to the rack, you were able to click through the instruments in the tree view pane, and click the tabbed pages to review or change any settings.

At this point, only the **Recorder** settings are available. The first **Rack** tabbed page is always the same for all virtual instruments here, you can **start** and **stop** MC_Rack (that is, the **data acquisition** or the **Replayer**), and activate the **recording** (that is, writing data to **hard disk**).

The **Lag** status bar gives you information on the computer performance; the lower the **Lag**, the better the performance. When the **Lag** exceeds the maximum, MC_Rack will be stopped automatically, and you will be informed about a performance limit of the computer by an error message. The complexity limit of the virtual rack depends directly on the computer performance. To avoid data loss during over night recordings, for example, test the rack configuration thoroughly under realistic conditions (that is, the signal rate should be as expected in the real experiment) before starting the experiment. If you have trouble with the computer performance, please see the chapter Error Messages in the Troubleshooting section for more information on how to optimize the rack configuration.

In the **Recorder** settings, you select the **data streams** and **channels** that you want to save to the hard disk. You define the **path** and the **file** in which the acquired data will be saved, and you define other parameters like the recording mode (**continuous** or **triggered**), and the **maximum file size**.

The **Recorder** shows you the currently available **disk space** on the target hard disk. Please check the disk space and estimate how long you still can write data to the hard disk always before starting an experiment. Otherwise, data loss will occur when the disk is full. For example, if you record 60 electrode channels at a sampling frequency of 25 kHz, the data rate is 3 MB/s, that is 10.8 GB/h.

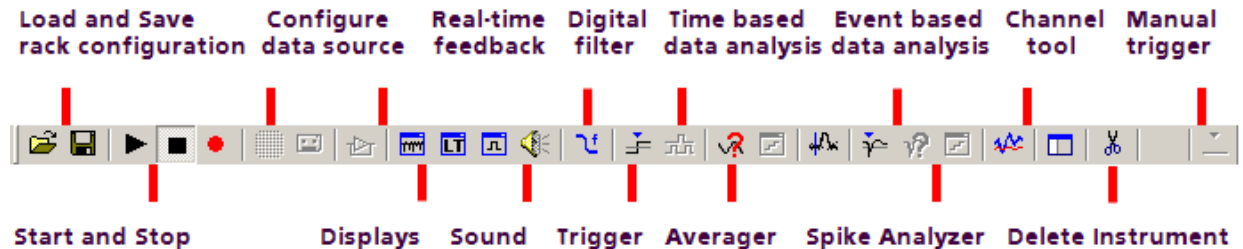

MC_Rack toolbar. For more detailed information on the toolbar buttons, please see "Toolbar" under General User Interface.

The MC_Rack toolbar shows all main functions available in MC_Rack. You can click on a **virtual instrument** button to insert a virtual instrument into your **rack configuration**. Please note that virtual instruments that need an **input data stream** that is generated by another virtual instrument (for example, the **Spike Analyzer**, which needs a **Spike** data stream generated by the **Spike Sorter**) can only be placed **in series** with the required virtual instrument and are otherwise not available (indicated by a gray button color). In an empty rack, only the data source, that is, the **data acquisition** or the **replayer**, are available to start with. After the data source was inserted into the rack, other virtual instruments will be available.

3.2.2 Defining the Data Source

MC_Rack is the universal data analysis program for all ME- and MEA-Systems with PCI card as well as with USB based data acquisition. To ensure correct display of the data of your system, it is therefore necessary to configure the data source accordingly. This has to be done only once for a given rack. See the MEA-System manual or the ME-System manual for the MC_Rack features that are supported by your system.

On the **Edit** menu, click **Data Source Setup** to configure the software according to your data acquisition and amplifier hardware. **Data Source Setup** is only available as long as no data source is included in a new rack file. Configure the channel layout first and then set up the rack for your experiment. The data source setup and channel layout information is saved together with the rack.

MEA60-System

Select **2 dimensional (MEA)** if you are performing extracellular recordings from microelectrode arrays (MEA) with a MEA60-System with 60 electrode channels. The number and layout of channels is pre-configured and cannot be altered. You have three additional analog channels (A1, A2, A3), and an additional 16-bit digital channel available. The standard BNC connectors for the digital channel on the data acquisition computer support only three digital input bits (0, 1, 2). A digital IN / OUT extension is available that supports all 16 digital in- and output bits.

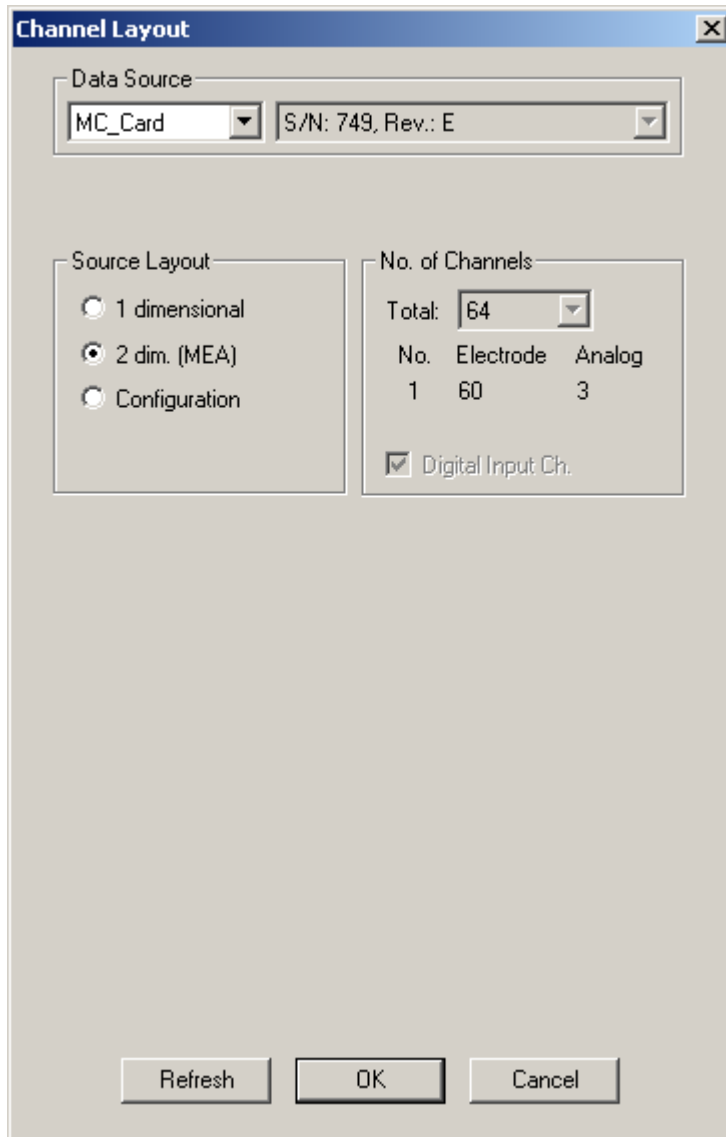

MEA120-System

Select **2 dimensional (MEA)** if you are performing extracellular recordings from microelectrode arrays (MEA) with a MEA120-System with 120 electrode channels. The number and layout of channels is pre-configured and cannot be altered. The MC_Card supports seven additional analog channels, but the BNC connectors on the data acquisition computer support only 3 additional analog channels (A1, A2, A3). You have an additional 16-bit digital channel available. The standard BNC connectors for the digital channel on the data acquisition computer support only three digital input bits (0, 1, 2). A digital IN/OUT extension is available that supports all 16 digital in-and output bits.

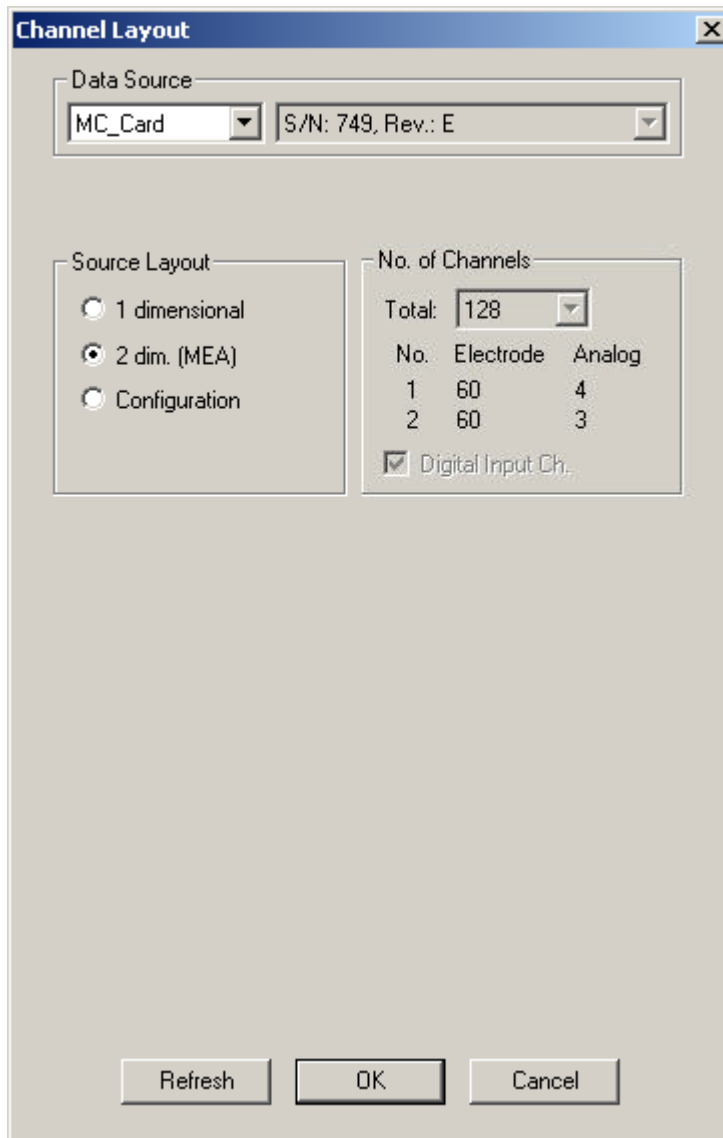

The Channel Layout dialog box is shown with the following settings:

- Data Source: MC_Card (S/N: 749, Rev.: E)
- Source Layout: 2 dim. (MEA) (selected)
- No. of Channels: Total: 128
- Table of channels:

No.	Electrode	Analog
1	60	4
2	60	3

Digital Input Ch.

Buttons: Refresh, OK, Cancel

ME-Systems

Select **1 dimensional** if you are using a ME-System (generally used for *in vivo* or special *in vitro* applications). ME-Systems are available with different channel numbers. Define the number of channels provided by the data acquisition (MC_Card or USB-ME), and specify how many **electrodes** (data amplified by the main amplifiers, for example, a MPA and a following filter amplifier) and how many **analog** inputs (for example, from a temperature controller or a microphone) are present. For the **electrode** channels, the original signal is calculated automatically according to the **gain** settings in MC_Rack. Signals on the analog channels are recorded "as is", with no respect to the gain.

Deselect the option **Digital Input Channel**, if you do not want to use the digital input channel. One of the digital input bits can be used for triggering the recording on a TTL output of the stimulator, for example. A typical configuration of a ME64-System would be 63 electrodes and a digital channel. Please note that the use of the digital input channel is available on the cost of an analog channel, that is, if you have an ME16-System and want to use the digital channel, for example for synchronizing stimulation and recording, you could only use a maximum of 15 electrode channels. Make sure that you select the digital channel if you want to trigger the data analysis and/or the recording.

Hint: Deselect the option Digital Input Channel, if you do not need a digital channel. Otherwise the number of electrode recording channels is reduced by 1!

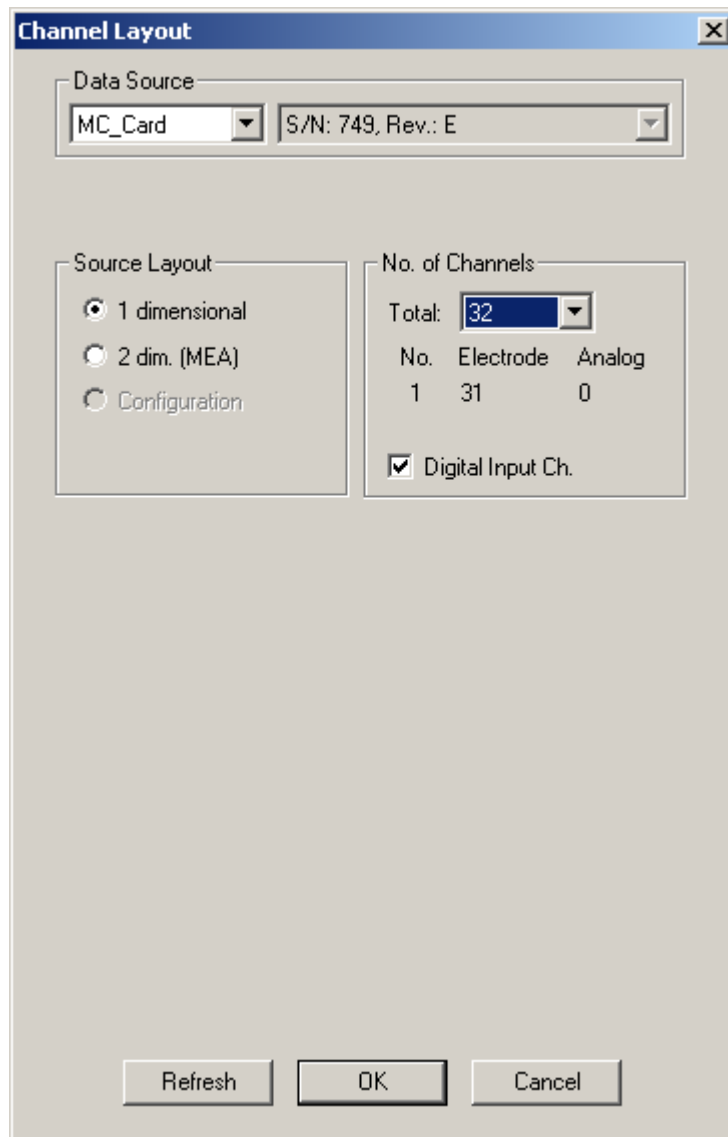

Data Source Configuration

Click "**Configuration**".

Configuration is an option that can also be used with MC_Card data acquisition (64 or 128 channels), but is recommended for the USB based data acquisition systems USB-ME64 / USB-ME/128 / USB-ME256 or MEA2100-System. When selecting the configuration option, it is first necessary to adjust the number of channels available. After that you can select the amplifier(s) and MEA(s) in use from a drop down menu. To configure the MEA layout, please use the right drop down menu "MEA". To configure the amplifier, please use the left drop down menu "Amp" (MEA1060 without blanking circuit, gain factor 1200, and MEA1060BC with blanking circuit, gain factor 1100 for MEA-Systems, and FA64I/S, FA32I/S for ME-Systems, MEA2100-H60 or MEA2100-H120 for MEA2100-System).

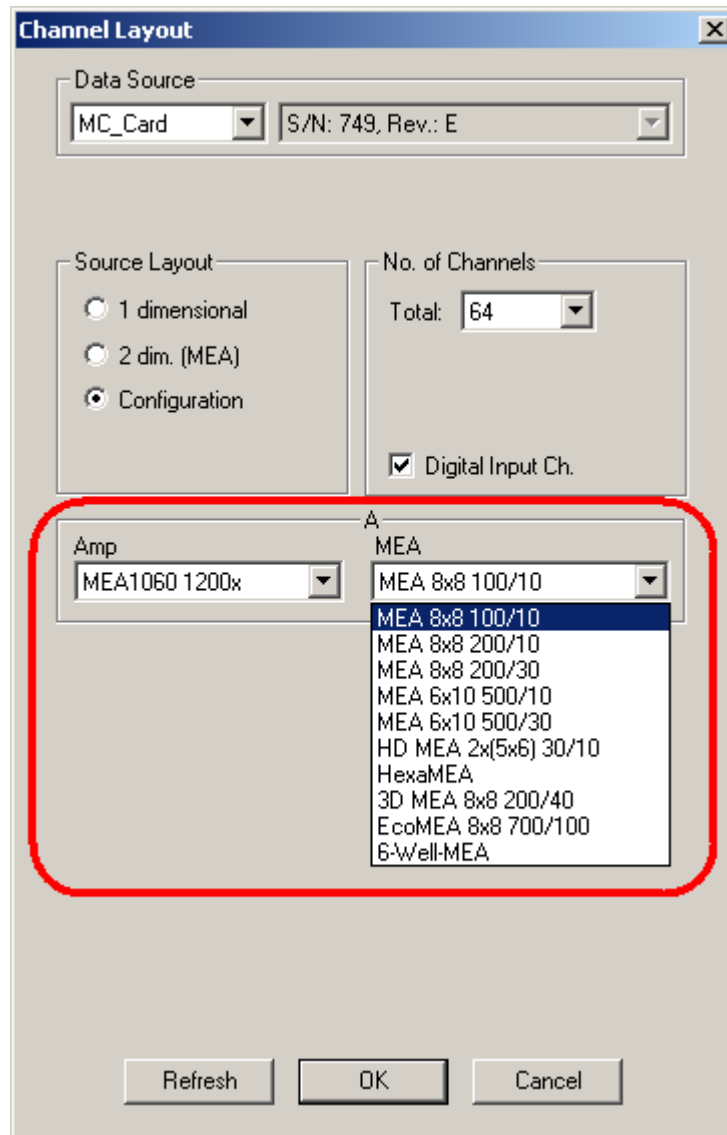

MC_Rack Manual

In MEA120-System it is possible to configure both amplifiers independent of each other. Additionally it is possible to configure the MEA layouts of MEA A and MEA B individually.

Note: Setting up the configuration of the data source is important for having the correct layouts for MEA A and MEA B during the complete experiment.

Channel Layout

Data Source: MC_Card Serial Number: 301, Revision: E

Source Layout:
 1 dimensional
 2 dim. (MEA)
 Configuration

No. of Channels:
Total: 128
 Digital Input Ch.

A
Amp: MEA1060 1200x
MEA: MEA 8x8 100/10

B
Amp: MEA1060-BC 1100x
MEA: HexaMEA

MEA 8x8 100/10
MEA 8x8 200/10
MEA 8x8 200/30
MEA 6x10 500/10
MEA 6x10 500/30
HD MEA 2x(5x6) 30/10
HexaMEA
3D MEA 8x8 200/40
EcoMEA 8x8 700/100

Refresh OK Cancel

USB-ME16-FAI-System

The USB-ME16-FAI System uses an internal data acquisition. Data can be transferred via USB 2.0 port to any data acquisition computer. Please see USB-ME16-FAI Manual for detailed information. Select **USB-MEA** from the left Data Source drop down list. The USB-MEA device will be specified on the right Data Source drop down menu: USB-ME16 (S/N: 00001). The number in brackets is the serial number of the device. The data source layout is 1 dimensional, with 16 electrode channels, and an additional digital channel.

The screenshot shows a dialog box titled "Channel Layout" with the following settings:

- Data Source:** USB MEA (left dropdown), USB-ME16 (S/N: 00001) (right dropdown)
- Source Layout:** 1 dimensional, 2 dim. (MEA), Configuration
- No. of Channels:** Total: 16 (dropdown)

No.	Electrode	Analog
1	16	0
- Digital Input Ch.

Buttons at the bottom: Refresh, OK, Cancel

USB-ME32-FAI-System

The USB-ME32-FAI System uses an internal data acquisition. Data can be transferred via USB 2.0 port to any computer. Please see USB-ME32-FAI Manual for detailed information. Select **USB-MEA** from the left Data Source drop down list. The USB-MEA device will be specified on the right Data Source drop down menu: USB-ME32 (S/N: 00001). The number in brackets is the serial number of the device. The data source layout is 1 dimensional, with 32 electrode channels, and an additional digital channel.

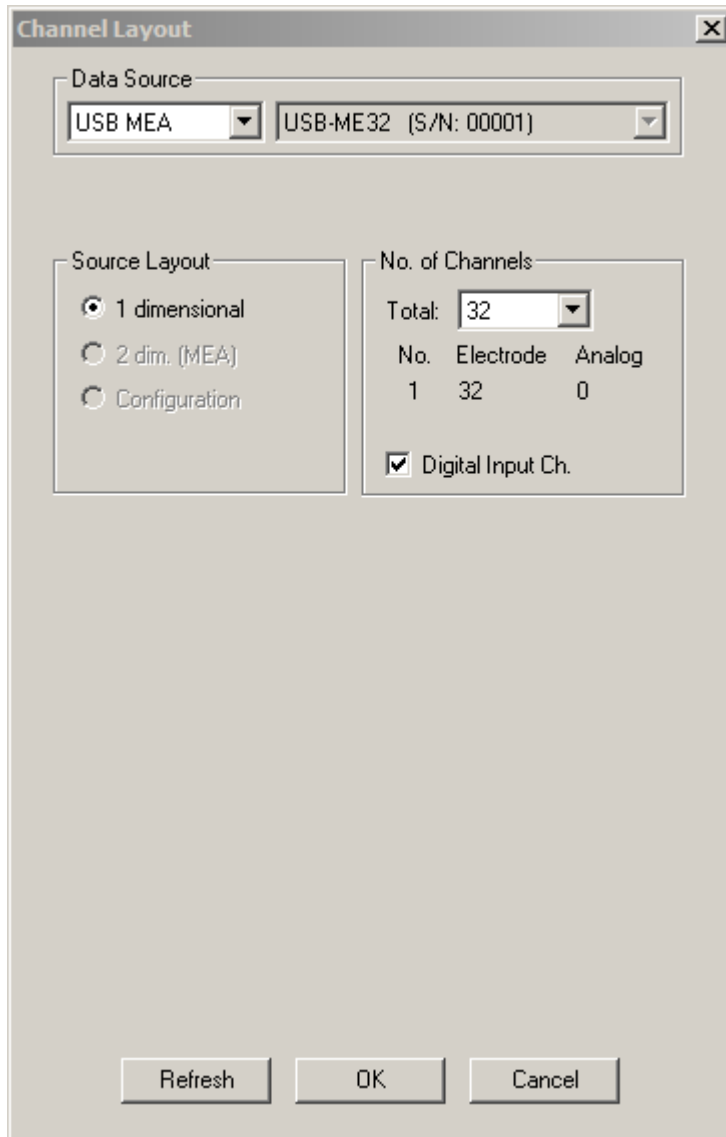

USB-ME64 / USB-ME128 / USB-ME256 Data Acquisition

The USB-ME64 / 128 / 256 data acquisition systems are in principle the same devices, except for the total number of channels.

USB-ME256 Data Acquisition

The USB-ME256 is an external data acquisition device that uses USB 2.0 connection to transfer digitized data to any connected computer. Please see USB-ME256-System manual for detailed information. Select **USB-MEA** from the left Data Source drop down list. The USB MEA device will be specified on the right Data Source drop down menu: USB-ME256 (S/N: 00004). The number in brackets is the serial number of the device. Adjust the number of channels available.

The screenshot shows the 'Channel Layout' dialog box with the following settings:

- Data Source:** USB MEA (left dropdown), USB-ME256 (S/N: 00004) (right dropdown)
- Virtual Device Configuration:** 1 x 256 (left dropdown), Block 1 (Channel 1 .. 256) (right dropdown)
- Source Layout:** 1 dimensional, 2 dim. (MEA), Configuration
- No. of Channels:** Total: 256 (dropdown), Digital Input Ch.
- Channel A:** Amp: MEA1060 1200x (dropdown), MEA (label), MEA 8x8 100/10 (dropdown)
- Channel B:** Amp: MEA1060 1200x (dropdown), MEA (label), MEA 8x8 100/10 (dropdown)
- Channel C:** Amp: MEA1060 1200x (dropdown), MEA (label), MEA 8x8 100/10 (dropdown)
- Channel D:** Amp: MEA1060 1200x (dropdown), MEA (label), MEA 8x8 100/10 (dropdown)

Buttons at the bottom: Refresh, OK, Cancel

MC_Rack Manual

Click Configuration in Source Layout. Choose 256 as total number of channels from the drop down list under No. of Channels.

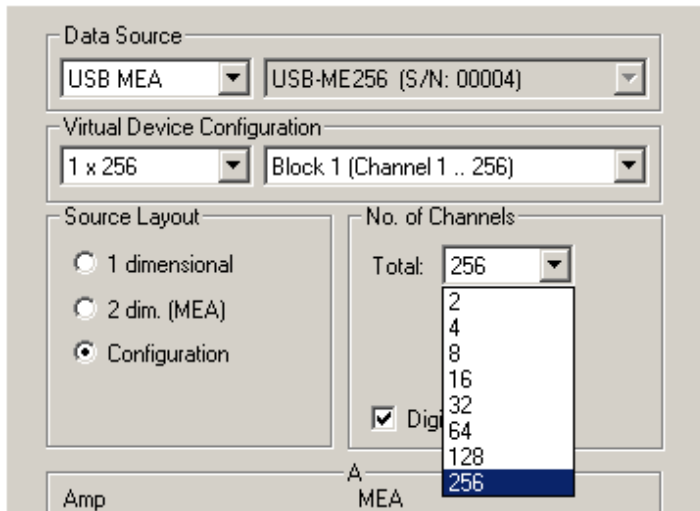

In USB-ME256-System it is possible to configure four MEA1060 / MEA1060BC amplifiers independent of each other. Click the Amplifier drop down menus on the left side. Additionally it is possible to configure the MEA layouts for up to four MEAs A and B, C and D independent of each other. Click the MEA drop down menus on the right side.

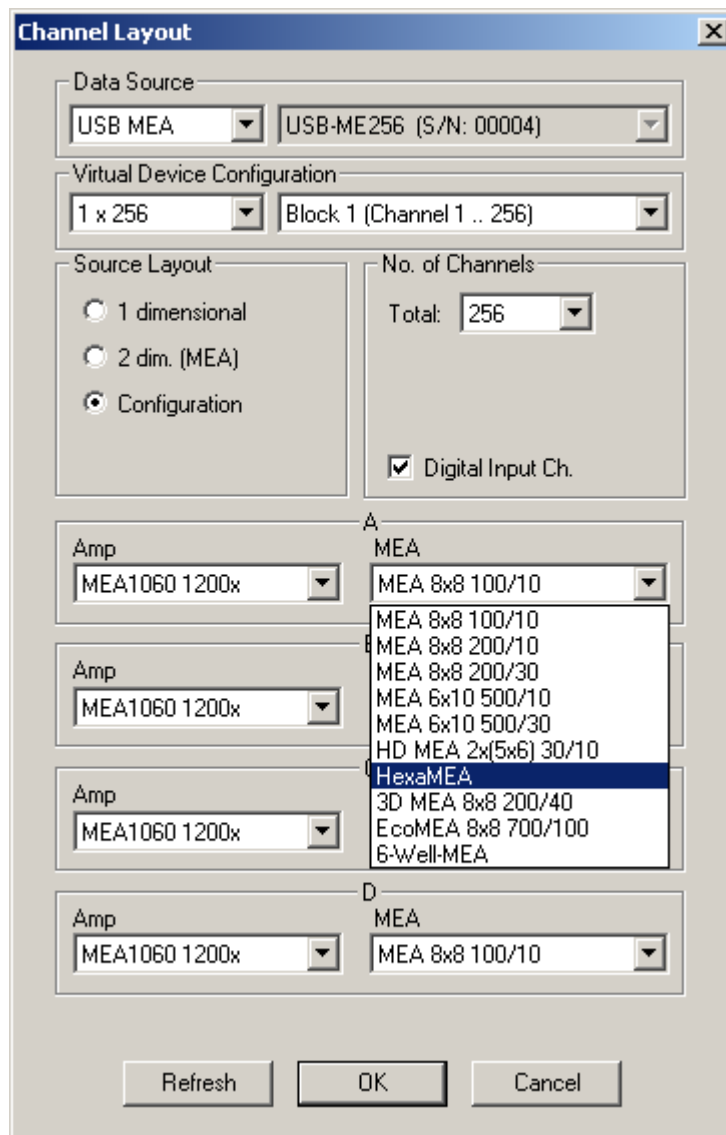

On the Edit menu, click Advanced Configuration to configure the software according to the USB-ME256 hardware. Please see Advanced Configuration for detailed information. The dialog **Advanced Configuration** is for optionally defining as many instances of MC_Rack software as necessary. That means, you are able to work with several MC_Rack versions in parallel, for example, when using the USB-ME256 with up to four MEA1060 amplifiers. With setting "Max. Number of MC_Rack Instances = 4" in Advanced Configuration you can control each of the four amplifiers independent from the others with its own MC_Rack software.

Note: Setting up the configuration of the data source is important for having the correct layouts for MEA A, B, C and D during the complete experiment.

USB-ME128 Data Acquisition

The USB-ME128 device is in principle the same device as the USB-ME256, except for the total number of channels that is 128.

The USB-ME128 is an external data acquisition device that uses USB 2.0 connection to transfer digitized data to any connected computer. Please see USB-ME128 Manual for detailed information. Select **USB MEA** from the Data Source drop down list. The USB MEA device will be specified on the right Data Source drop down menu: USB-ME128 (S/N: 0002), for example. The number in brackets is the serial number of the device.

In USB-ME128-System it is possible to configure two MEA1060 / MEA1060BC amplifiers independent of each other. Additionally it is possible to configure the MEA layouts for MEA A and MEA B independent of each other.

On the Edit menu, click Advanced Configuration to configure the software according to the USB-ME128 hardware. The dialog **Advanced Configuration** is for optionally defining as many instances of MC_Rack software as necessary. That means, you are able to work with several MC_Rack versions in parallel, for example, when using the USB-ME128 with two MEA1060 amplifiers. With setting "Max. Number of MC_Rack Instances = 2" in Advanced Configuration you can control each of the two amplifiers independent from the other with its own MC_Rack software.

Note: Setting up the configuration of the data source is important for having the correct layouts for MEA A and B during the complete experiment.

USB-ME64 Data Acquisition

The USB-ME64 device is in principle the same device as the USB-ME256, except for the total number of channels, that is 64.

The USB-ME64 is an external data acquisition device that uses USB 2.0 connection to transfer digitized data to any connected computer. Please see USB-ME64 Manual for detailed information. Select **USB MEA** from the Data Source drop down list. The USB MEA device will be specified on the right Data Source drop down menu: USB-ME64 (S/N: 0002), for example. The number in brackets is the serial number of the device.

In USB-ME64-System it is possible to configure the MEA1060 / MEA1060BC amplifier. Additionally it is possible to configure the layout of MEA A.

Note: Setting up the configuration of the data source is important for having the correct layout for MEA A during the complete experiment.

USB-MEA256 Data Acquisition and Filter Amplification

The USB-MEA256 is an external data acquisition device with integrated filter amplifier that uses USB 2.0 connection to transfer digitized data to any connected computer. Please see USB-MEA256 Manual for detailed information. Select **USB-MEA** from the left Data Source drop down list. The USB-MEA device will be specified on the right Data Source drop down menu: USB-MEA256 (S/N: 00007). The number in brackets is the serial number of the device.

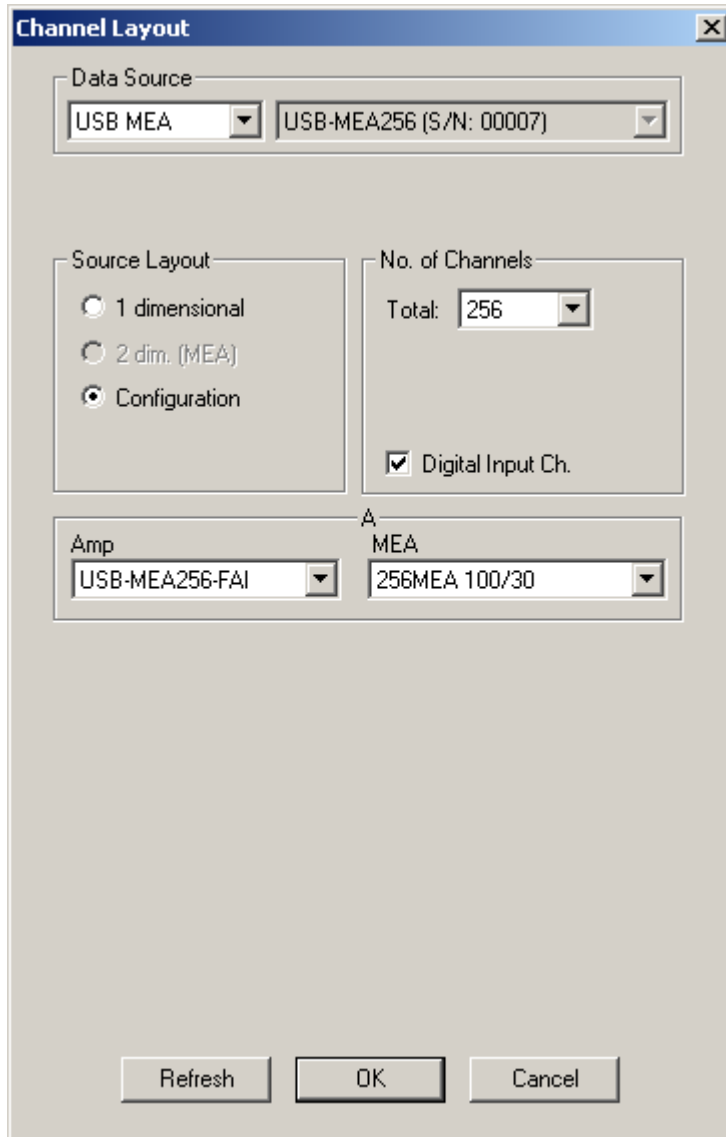

Wireless Recording System

The wireless *in vivo* recording system is the all-in one solution for amplifying, recording, and analyzing *in vivo* data from eight channels that uses a wireless connection between headstage and receiver and an USB 2.0 connection to transfer digitized data to any connected computer. Please read the Wireless-System manual for detailed information. Select USB MEA from the left Data Source drop down list. The wireless system device, W8 for example, will be specified on the right Data Source drop down menu: MCS WPA8 (S/N: 00001). The number in brackets is the serial number of the system. The data source layout is 1 dimensional, with 8 electrode channels and an additional digital channel.

Note: With all electrode channels, the maximum sampling rate for the 8-channel Wireless Recording System W8-System is 20 kHz. It is possible to increase the maximum sampling rate up to 40 kHz by deactivating at least four electrode channels. Please pay attention to the sampling rate respectively, when using the W4-, W16- or W32-System.

Channel Layout

Data Source

USB MEA MCS WPA8 (S/N: 00001)

Source Layout

1 dimensional
 2 dim. (MEA)
 Configuration

No. of Channels

Total: 8

No.	Electrode	Analog
1	8	0

Digital Input Ch.

Refresh OK Cancel

MEA2100-System

The MEA2100 recording system is an all-in one solution consisting of headstage and interface board. The MEA2100-System with integrated amplification, data acquisition, online signal processing, and integrated stimulus generator. You can connect one or two headstages to the interface board. The MEA2100-System uses an USB 2.0 connector per headstage to transfer digitized data to any computer. Please read the MEA2100-System manual for detailed information. Please read also chapter "Data Source Setup" in "MEA2100-System".

Select USB MEA from the left Data Source drop down list. The MEA2100 device will be specified on the right Data Source drop down menu: MEA2100 (S/N: 0000-A).The number in brackets is the serial number of the system, the character A labels the connected headstage, A is the first headstage, B is the second headstage. It is possible to run up to two instances of MC_Rack per headstage. Please read chapter "Advanced Configuration". Specify the "Number of Channels" first: 32 electrode channels, when connecting one headstage with 32 recording and 12 stimulation electrodes (MEA2100-HS32), 64 when connecting one headstage with 60 channels (MEA2100-HS60) or 128 electrode channels when connecting two headstages with 60 channels (MEA2100-HS60) or one headstage with 120 channels (MEA2100-HS2x60 or MEA2100-HS120) to the interface board. Choose "Configuration" in the data source layout. Enable the check box for the digital input channels. Select the correct headstage in the "Amplifier" drop down menu and specify the type of MEA.

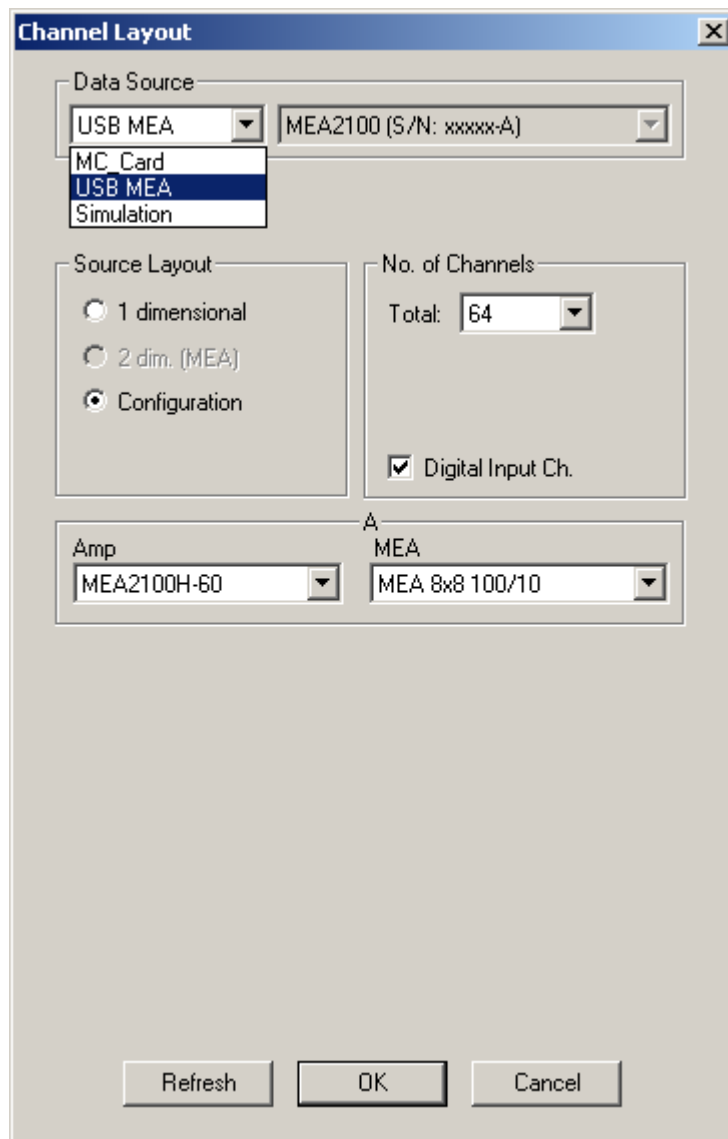

In MEA2100-System it is possible to configure two headstages independent of each other. MC_Rack identifies two connected headstages as completely different devices. They are defined via the character A or B in the serial number in the right "Data Source" drop down menu.

It is also possible to run two MC_Rack instances per headstage, for example for recording from the 2x60 channels of the MEA2100-HS2x60 headstage separately. Please read chapter "Advanced Configuration". Click the Amplifier drop down menus on the left side to configure the "Amplifier". Additionally it is possible to configure the MEA layouts for up to two MEAs A and B independent of each other. Click the MEA drop down menus on the right side.

MEA2100-32-System

The MEA2100-32-System is a descendant of the MEA2100-System with the same functions except of the real-time feedback. Please read the MEA2100 Manual for detailed information. Select **USB** from the left Data Source drop down list. The MEA2100-32 device will be specified on the right Data Source drop down menu: MEA2100-32 (S/N: 00018-A). The number in brackets is the serial number of the device. The data source layout is Configuration, with 32 electrode channels. It does not matter whether you select the digital input channel or not.

Channel Layout

Data Source
USB | MEA2100-32 (S/N: 00018-A)

Virtual Device Configuration
2 x 40 | Block 1 (Channel 1 .. 40)

Source Layout
 1 dimensional
 2 dim. (MEA)
 Configuration

No. of Channels
Total: 32
 Digital Input Ch.

Amp | MEA
MEA2100H-32 | pMEA-32S12-L1

Refresh | OK | Cancel

3.2.3 Advanced Configuration

Important: This feature can only be used when working with the USB based data acquisition systems USB-ME256 and USB-ME128. If you use a MC_Card or an USB-ME-16/32-FAI, please do not change the default setting of "Max. Number of MC_Rack Instances = 1".

On the Edit menu, click Advanced Configuration to select the maximum number of instances of MC_Rack that can run simultaneously. These instances operate independently from each other.

This feature is meant to be used with the new USB based data acquisition systems **USB-ME256** and **USB-ME128**. When two or four amplifiers are connected to the data acquisition, it is possible to operate **each amplifier independently** with one instance of MC_Rack. It is also possible to operate 128 or 256 channels with one instance of MC_Rack, for example, when working with an **USB-MEA256** amplifier and a MEA with 256 electrodes. See Data Source Setup for details on the configuration. Up to four instances of MC_Rack can be started in parallel.

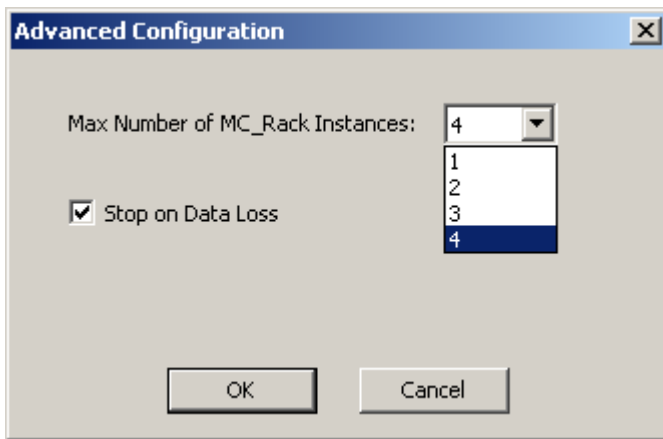

If the option "**Stop on Data Loss**" is selected, the MC_Rack program stops recording if it encounters problems during recording of a file. An error message will be displayed in the status bar.

Operating 256 channels with USB-ME256 device with one instance of MC_Rack

Using an USB-ME256 device, it is possible to operate 256 channels with one instance of MC_Rack.

1. Connect an USB-ME256 device to the data acquisition computer. Start MC_Rack software program.
2. Click Edit: Advanced Configuration and keep the default setting: Max. Number of MC_Rack Instances = 1.
3. Click Edit: Data Source Setup and select USB MEA under Data Source.
4. Virtual Device Configuration: Click 1 x 256 from the drop down list on the left. In Virtual Device Configuration drop down list on the right Block 1 (Channel 1...256) is displayed.
5. Source Layout: Choose Configuration in Source Layout and the total number of 256 from the drop down list in No. of Channels.
6. Configure the connected amplifiers and MEA layouts independently from each other from the available drop down menus.

The same proceeding is possible with **USB-ME128** device. The total number of channel is reduced to 128 channels, respectively.

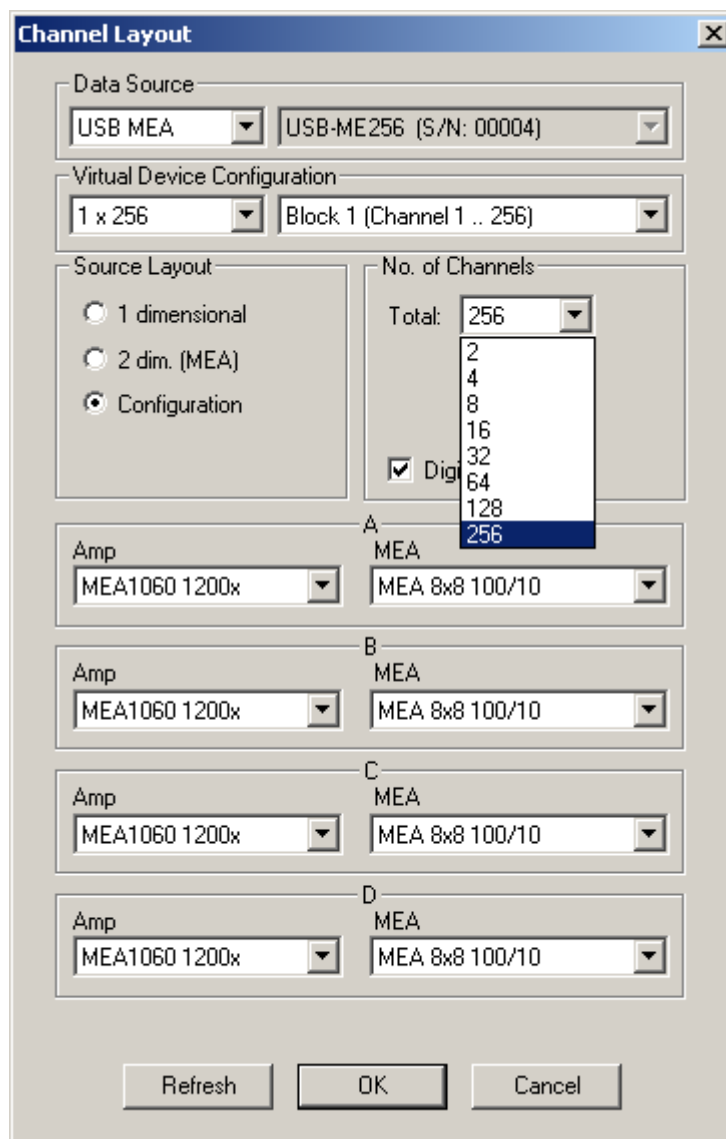

Important: If working with one instance of MC_Rack, data acquisition from all four amplifiers can only be started in parallel, and all data will be saved in the same file.

Operating 256 channels with USB-ME256 device with four instances of MC_Rack

Using an USB-ME256 or an USB-ME128 device, it is possible to operate 128 or 256 channels with two or four instances of MC_Rack.

Click Advanced Configuration to select the number of instances of MC_Rack that you want to run simultaneously. Please see screen shot above.

Example: Operating an USB-ME256 device with four amplifiers and with four instances of MC_Rack.

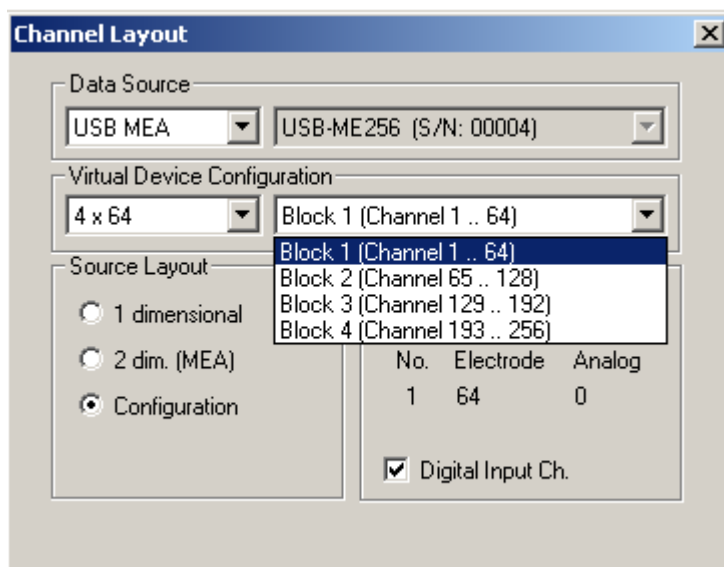
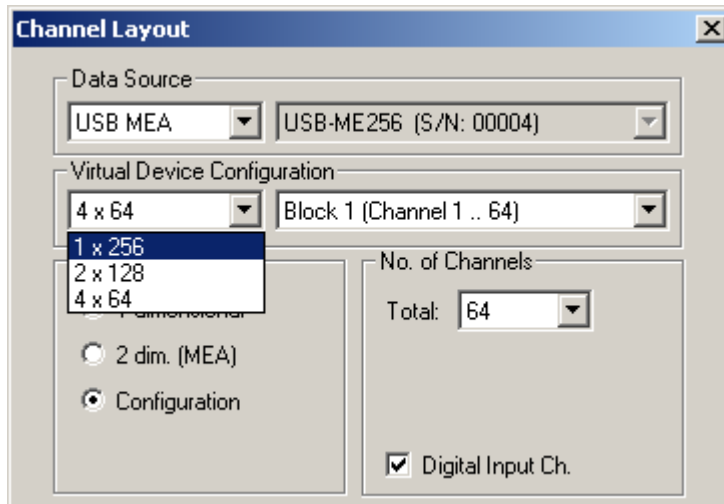

1. Connect an USB-ME256 device to the data acquisition computer. Start the first instance of MC_Rack. Click Edit: Advanced Configuration and define Max. Number of MC_Rack Instances = 4.
2. Click Edit: Data Source Setup and select USB MEA under Data Source. Choose 4 x 64 channels from the left drop down menu in Virtual Device Configuration, and Block 1 (Channel 1...64) from the right drop down menu. Block 1 corresponds with input A of the USB-ME256.
3. Configure the correct amplifier type and electrode layout for input A
4. Open the second instance of MC_Rack software program.
5. Click Edit: Data Source Setup and select Block 2 (Channel 65...128) from the right drop down menu. Block 2 corresponds with input B of the USB-ME256.
6. Configure the correct amplifier type and electrode layout for input B.
7. Open the third instance of MC_Rack software program.

8. Click Edit: Data Source Setup and select Block 3 (Channel 129...192) from the right drop down menu. Block 3 corresponds with input C of the USB-ME256.
9. Configure the correct amplifier type and electrode layout for input C.
10. Open the fourth instance of MC_Rack software program.
11. Click Edit: Data Source Setup and select Block 4 (Channel 193...256) from the right drop down menu. Block 4 corresponds with input D of the USB-ME256.
12. Configure the correct amplifier type and electrode layout for input D.
13. If you try to open a fifth instance of MC_Rack an error message will be displayed. Please see Troubleshooting.

Now you are able to operate the different blocks of 4 x 64 channels with independent MC_Rack instances, and with independent configured amplifiers and MEA layouts.

The same proceeding is possible with **USB-ME128** device. The total number of channel is reduced to 128 channels and two blocks and inputs (A and B), respectively.

The Reuse of an existing Rack File with multiple Instances of MC_Rack

The reuse of an existing rack file with multiple instances of MC_Rack running on the same computer is explained, using the example of the USB-ME256-System. If you are working with an MEA2100-32-System, please operate in the same principle.

Opening an existing Rack File with USB-ME256 and multiple Instances of MC_Rack

If you build up (and saved) a complicated rack in the first instance of MC_Rack which you want to reuse in the second instance of MC_Rack, please do the following:

1. Start the second instance of MC_Rack.
2. Click "Open" in File menu. The dialog "Open Rack Files" appears. Select the desired rack file.
3. Before the selected file will open in the second instance of MC_Rack, you have to change the data source specification from the copied file. That is why the dialog "Channel Layout" in "Data Source Setup" will automatically appear again. Please choose the appropriate MEA amplifier via block number, assigned the second instance of MC_Rack.

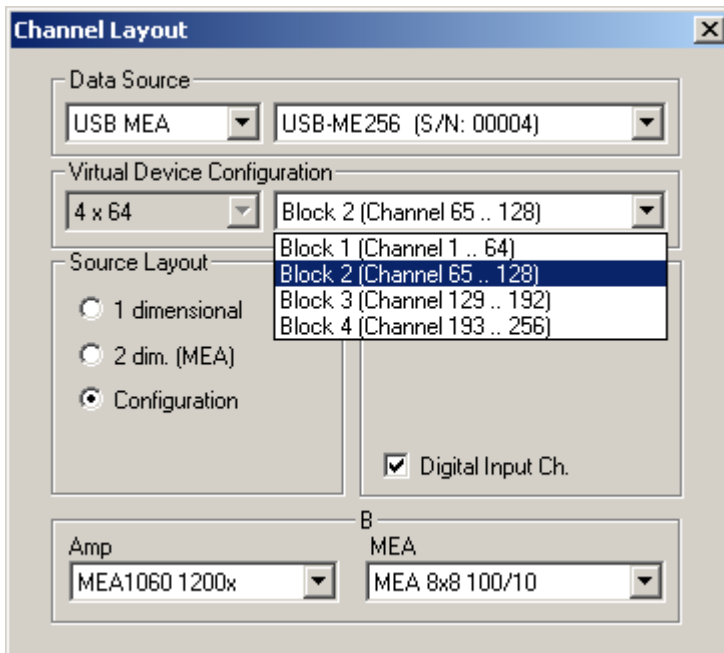

4. Now the reused rack file will be opened in the second instance of MC_Rack. The data source used for the rack is shown in the blue header of the dialog and after the data source icon.

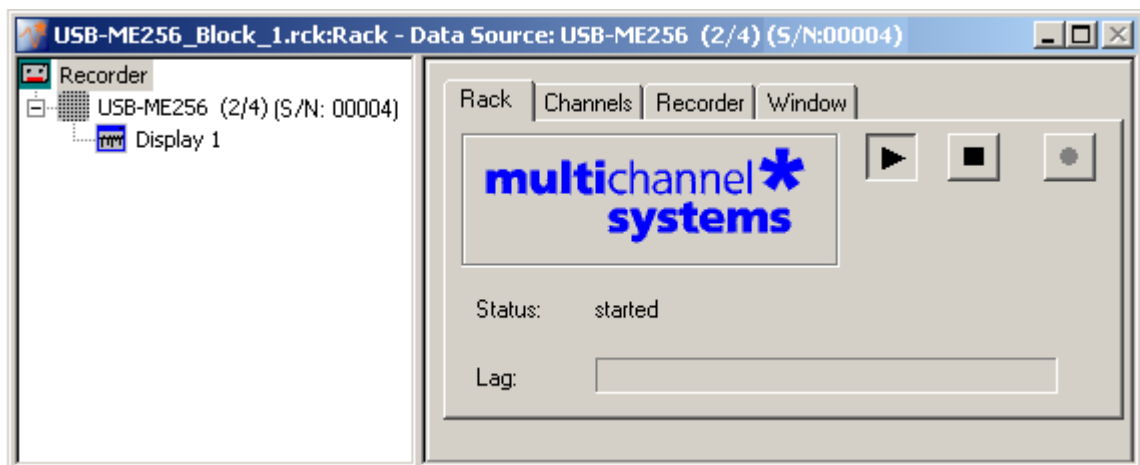

Note: Please do not miss one of the described steps when reusing an existing file! Otherwise you have to delete the rack and start the instance of MC_Rack again.

Repeat step 1 to 4 to open the third and fourth instance of MC_Rack with an existing file to control the amplifiers three and four.

Operating two MEA2100-32-Systems with multiple instances of MC_Rack

Using a MEA2100-32-System with two MEAs or two headstages with two MEAs, it is possible to operate up to four devices with up to four instances of MC_Rack, running on a single data acquisition computer.

Click "Advanced Configuration" to select the number of instances of MC_Rack that you want to run simultaneously. Please see screen shot above.

Important: It is not possible to connect one device with more than one instance of MC_Rack.

1. Start the first instance of MC_Rack.
2. Click Data Source Setup on the Edit menu. Select USB on the left drop down menu of the "Data Source", and MEA2100-32 on the right drop down menu. Please see chapter "Defining the Data Source". Select the block you want to control with the first instance of MC_Rack "Block" number.

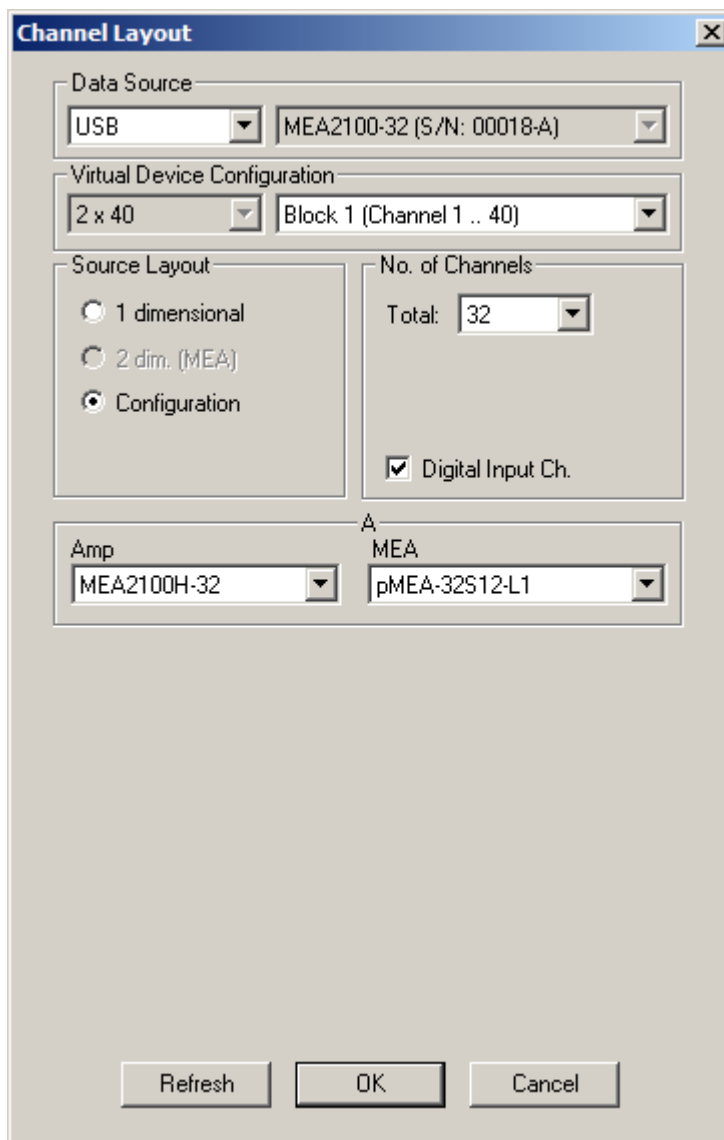

3. Select Configuration in Source Layout. The total number of channels is 32 with an additional digital input channel or not.
4. Add MEA2100-32 (S/N 00018-A, headstage A), for example, as the data source to your virtual rack for the first instance of MC_Rack. The data source and its serial number are displayed in the blue header of the dialog of the "Rack" tab as well as on the left side of the display.

MC_Rack Manual

5. Start the second instance of MC_Rack.
6. Click "Data Source Setup" in Edit menu. Select the headstage you want to control with the second instance of MC_Rack via serial number, for example MEA2100-32 (S/N:00018-B). Add the desired data source. The data source and its serial number are displayed in the blue header of the dialog of the "Rack" tab (second instance) as well as after the data source icon.

Opening an existing Rack File with MEA2100-32-System and multiple instances of MC_Rack

If you build up (and saved) a complicated rack in the first instance of MC_Rack which you want to reuse in the second instance of MC_Rack, please do the following: Start the second instance of MC_Rack.

1. Click "Open" in File menu. The dialog "Open Rack Files" appears. Select the desired rack file.
2. Before the selected file will open in the second instance of MC_Rack, you have to change the data source device specification from the copied file. That is why the dialog "Channel Layout" in "Data Source Setup" will automatically appear again.
3. Please choose the appropriate MEA2100-32 headstage via block number, assigned the second instance of MC_Rack.
4. Now the reused rack file will be opened in the second instance of MC_Rack. The data source used for the rack is shown in the header and after the data source icon.

Note: Please do not miss one of the described steps when reusing an existing file! Otherwise you have to delete the rack and start the instance of MC_Rack again.

Maximal Sampling Frequency

Usually, the maximal sampling frequency for MCS data acquisition systems is 50 kHz. However, when using some advanced features of the USB-ME256 and USB-ME128, some limitations apply.

The maximal sampling frequency that can be achieved with 256 channels is 40 kHz. This is possible when using the USB-ME256 with the "Virtual Device Configuration" 1 x 256 (Please see above). With the USB-ME128 and USB-ME256 it is also possible to split the data stream into 2 x 64 or 2 x 128 and 4 x 64 channels, respectively, again by using the "Virtual Device Configuration". These virtual machines can then be controlled independently by up to four instances of MC_Rack. However, splitting the data stream into several virtual devices consumes system performance. Therefore, the maximal sampling frequency is limited to 25 kHz when using the virtual device configuration 2 x 64 (USB-ME128) or 2 x 128 and 4 x 64 channels (USB-ME256).

The Additional Analog Channels A1 to A4

The devices USB-ME256, USB-ME128, USB-ME64 and USB-MEA256 are equipped with four additional analog channels A1 to A4. Please refer to the respective manuals.

The additional analog channels A1, A2, A3 and A4 are available in MC_Rack data display and in MC_Rack long term display.

Note: Because of the different scaling of electrode data channels and the additional analog channels, it is recommended to visualize the analog channels in a separate display.

Availability of Additional Analog Channels in USB-ME256 (and USB-ME128 respectively)

Depending on the selected "Source Layout", it is possible that no or not all additional analog channels are available. To have full access to the analog channels, please use the "Configuration" option of the data source setup. If other data source layouts are selected, limitations apply:

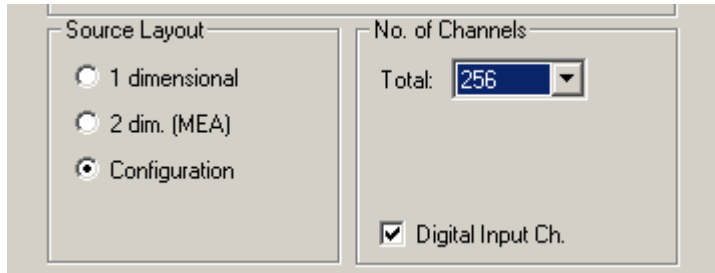

Source Layout 1 dimensional: No additional analog channels are available.

Source Layout 2 dim. (MEA): Three additional analog channels are available A1, A2, A3.

Source Layout Configuration: All four additional analog channels are available A1, A2, A3 and A4.

Visualizing the Additional Analog Channels

Click  to add a data display. On the left window pane of the dialog the data display appears, labeled "Display 1". Double click on "Display 1" to rename the display for discrimination of the analog and electrode displays.

In the "Data" tab, select "Analog Raw Data" only.

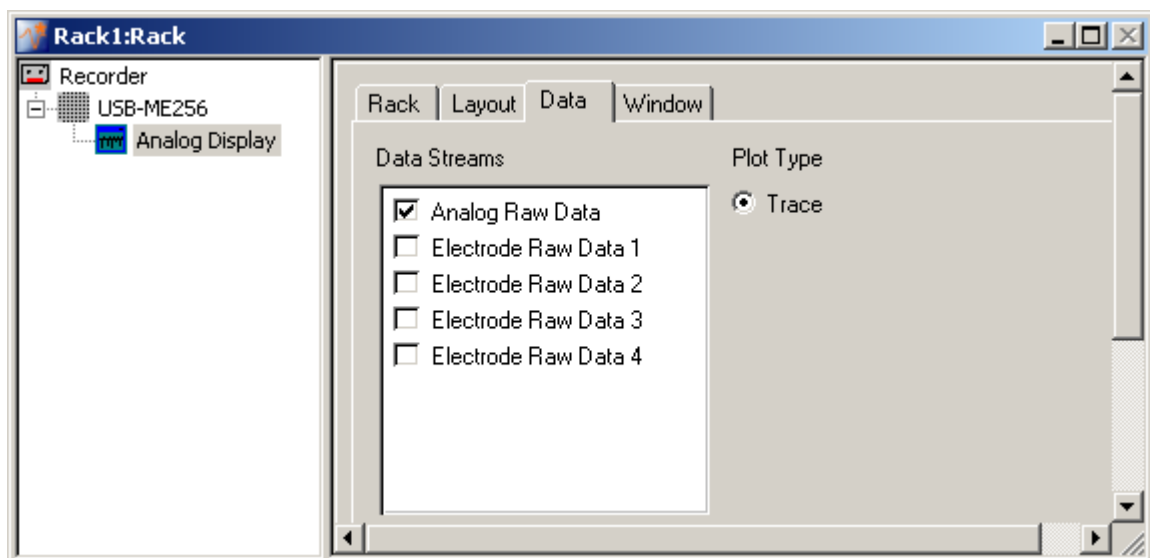

MC_Rack Manual

In the "Layout" tab, select the "Default Map". The additional analog channels A1 to A4 are displayed. It is also possible to use a custom layout (for example 2x2 electrodes). Please see chapter "Monitoring Activity" for more information about designing channel maps.

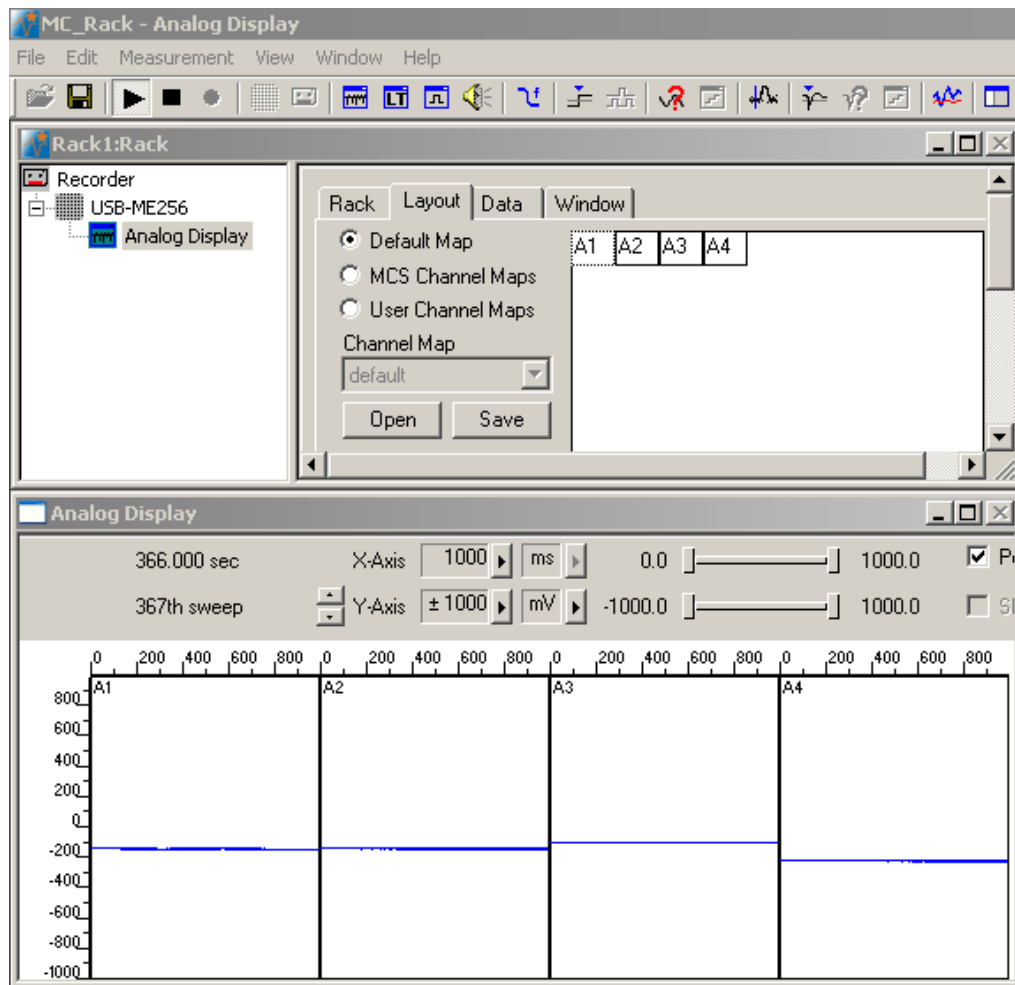

Additional Analog Channels with Different Instances of MC_Rack

If you use the Advanced Configuration to run more than one instance of MC_Rack at once, the same four additional analog channels A1 to A4 can be displayed in any of these instances.

3.2.4 Adding a Data Source

In MC_Rack, the **input data streams** for the virtual rack can come from different data sources: From the data acquisition board of the **MEA2100-System** or from the **Replayer**, that is, from previously recorded data (*.mcd) files, or from **USB based data acquisition** systems like USB-ME256, USB-MEA256, USB-ME16-FAI-Systems or from the MC Card.

Here, we want to acquire new data and choose, for example the **MC_Card** as data source.

1. Click the electrode array symbol  on the toolbar or click **Add MC_Card** on the **Edit** menu. The program detects the MC_Card automatically. If you have no MC_Card installed on the computer, the simulation mode is started automatically, and you will be informed by a message. (If you have a MC_Card, but you still get an error message, the driver installation may be invalid. Please contact your local retailer for support.)
You see the **MC_Card** virtual instrument in your virtual rack. When you select the **MC_Card** so that the name appears highlighted in blue, you see three tab pages on the right: The general **Rack** tabbed page, and the **MC_Card** specific **Hardware** and **Info** tabbed page. In the **Hardware** page, you can define the hardware related settings. The **Info** page shows the channel layout.

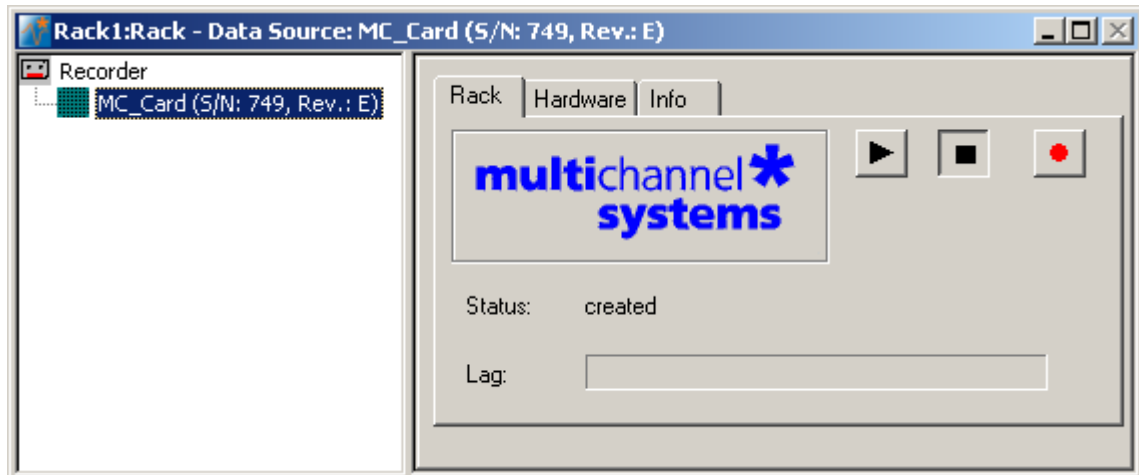

2. In the tree view pane of the virtual rack, select the MC_Card, click the **Info** tab, and check the channel layout settings that you have defined in the last step. You cannot modify the settings anymore once you have added the **MC_Card**. If the settings are not appropriate, remove the **MC_Card** from the rack (by selecting the MC_Card in the tree view pane of the virtual rack and pressing DELETE), and go back to the last step "Defining the Data Source".
The following screen shot shows the information on the standard layout for the MEA60-System.

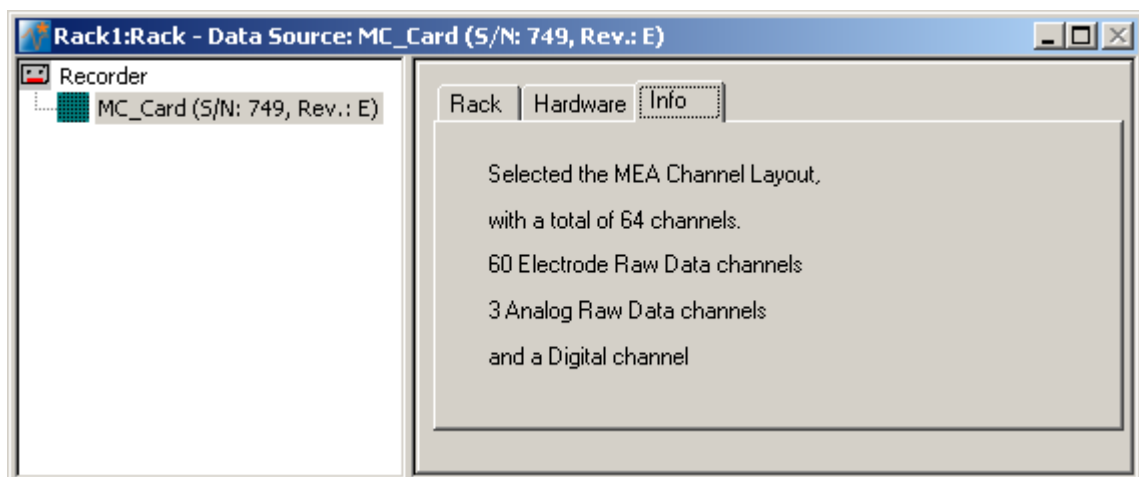

- Click the **Hardware** tab. Here, you can define hardware related parameters. Please note that the **amplifier gain** is an intrinsic property of the amplifier and **cannot** be altered, whereas the **input voltage range** and the **sampling rate** of the data acquisition card can be adjusted to your needs. On this page, you will also find hardware related information like the MC_Card driver version and the serial number. Please keep this information at hand when contacting the support.

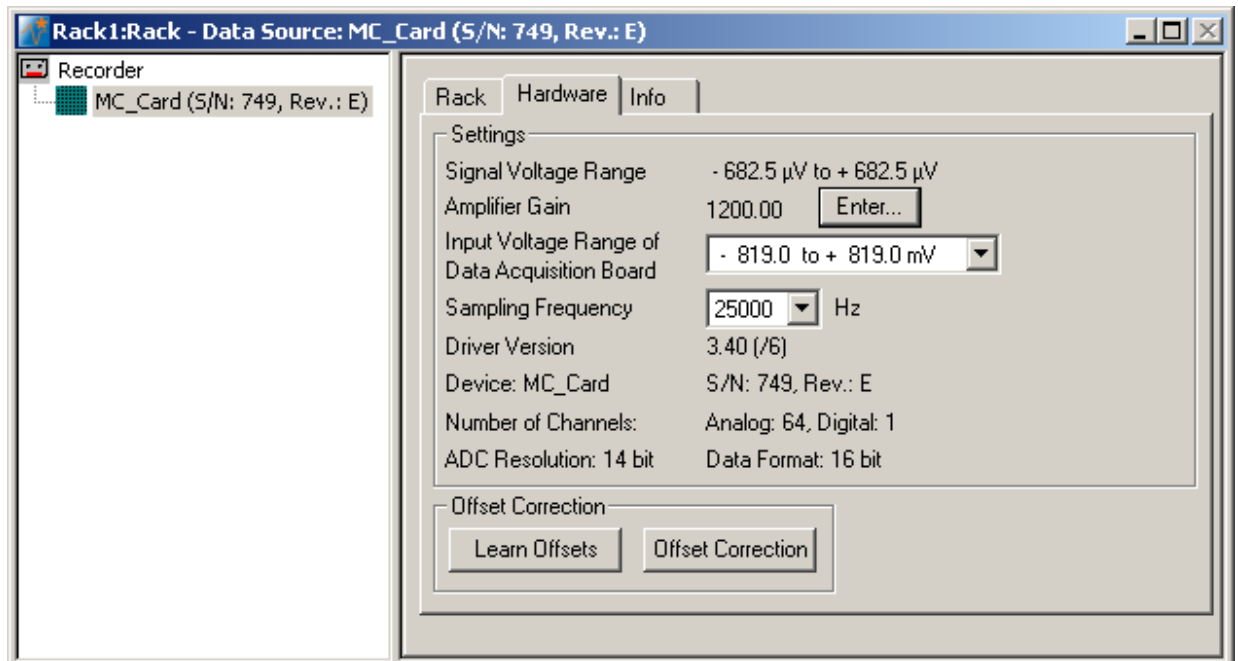

- Click **Enter** to enter the **Amplifier Gain** settings according to your hardware. The gain settings are used for scaling and displaying the signals properly. So if you specified a wrong gain, you would perceive wrong signal amplitudes leading to false documentation and results. The default settings are 1200 for the standard MEA1060 amplifier, and 1100 for the standard MEA1060-BC amplifier. The amplifier gain of the MEA2100-System is automatically set, depending on the version of the hardware. If you have a ME-System, you should enter the total gain of the amplifiers. For example, if you have a MPA8I (with a gain of 10) and a filter amplifier with a gain of 100, you have a total gain of 1000. Please check the technical specifications of the connected amplifier(s) and make sure that you enter an appropriate value.
- Select an **Input Voltage Range of Data Acquisition Board** for the MC_Card from the drop-down list. For standard signals and a standard gain amplifier, the default input range of -819 to +819 will be fine. You need a higher input voltage range if your biological sample generates higher voltages, for example, cardiac signals from whole-heart preparations, and/or the amplifier gain is considerably higher. The lower the input voltage range, the higher is the voltage resolution. Please see also Defining MC_Card Settings in the MC_Rack Features section.
- The **Signal Voltage Range** is calculated from the Input Voltage Range of the Data Acquisition Board divided through the Amplifier Gain Factor.
- Select a **Sampling Rate** from the drop down list. For most applications, 25 kHz will be fine. Please see also Defining MC_Card Settings in the MC_Rack Features section.
- An **Offset Correction** is generally not necessary. You may use it when you observe a disturbing voltage offset on the input channels. Or you may use it during testing the system with a test model probe. Make sure that there are no signals on the channels when using the offset correction. Click **Offset Correction** to activate the Offset Correction. Click **Learn Offsets** to perform an individual offset correction for each input channel. MC_Rack takes **100 ms** of the recorded data in the moment when the button is pressed to calculate the DC offset. The mean of this 100 ms sweep is subtracted from the recorded data as long as the **Offset Correction** button is pressed. The individual offset values for each channel are saved in the local settings of the data acquisition computer and are only overwritten when you click **Learn Offsets** again. Make sure you press the **Learn Offsets** button **only** when you have no real input signals or irregular noise signals on the electrodes. To be on the safe side, connect a test model probe to the amplifier.

3.2.5 Channel Tool

The **Channel Tool** feature in MC_Rack allows the selection of one MEA electrode as reference electrode. The tool works similar to the offset correction and influences the signal to noise ratio. If there are problems with homogenous noise on all electrodes, the user is able to select one electrode without signal as reference. The voltage value of this reference electrode will be mathematically subtracted sample point per sample point from all electrode signals in the stream. For example, a low frequency noise on all electrodes will be eliminated this way.

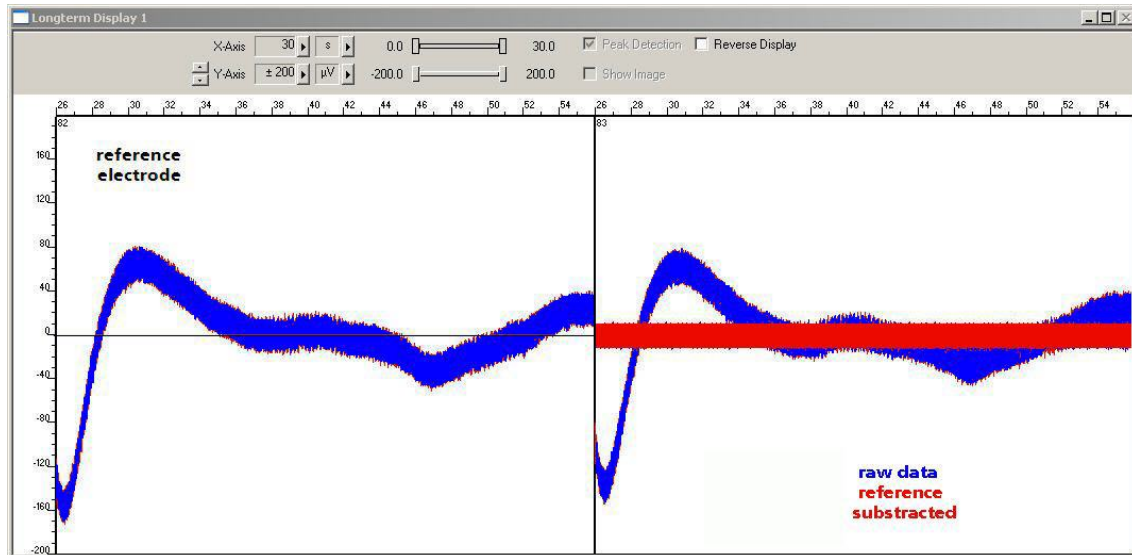

Note: Be careful to choose an electrode with noise only as reference electrode. If the reference electrode contains signals too, the value of the signals will be subtracted together with the noise value, and falsify the data.

Click the "**Channel Tool**" icon  in the main window toolbar, or select "Channel Tool" from the Edit menu. The following dialog appears. Click the "**Channels**" tab.

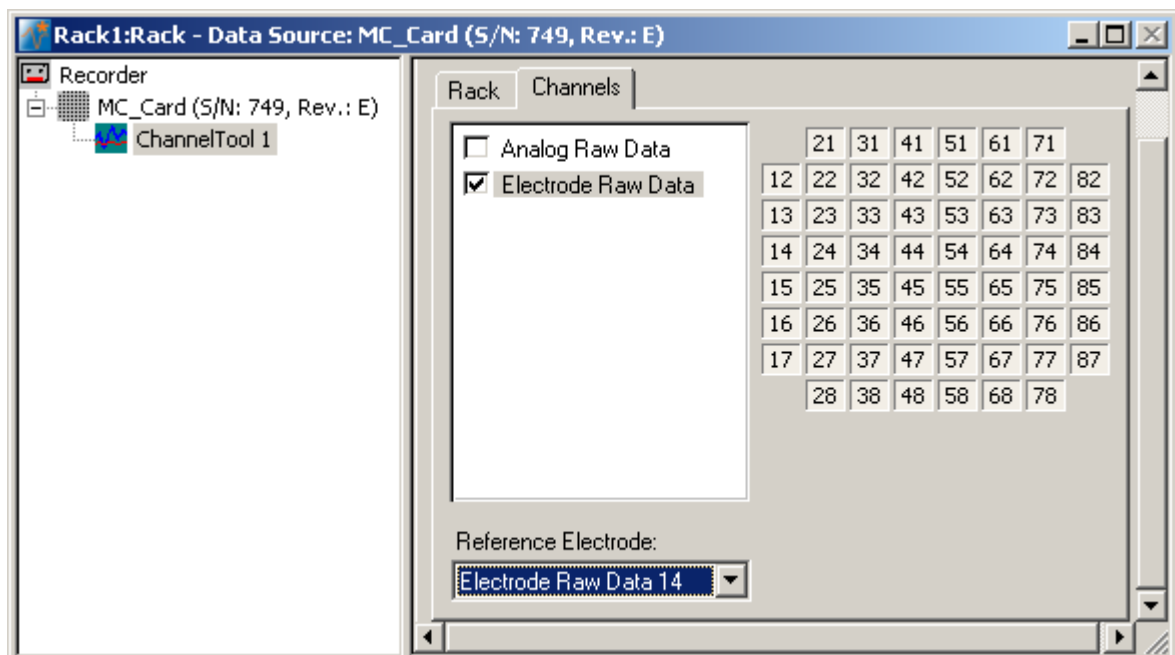

Select the data stream you want to apply the channel tool: Electrode Raw Data in this example. Select a "**Reference electrode**" from the "Reference electrode" drop down menu.

Important: Data streams recorded with the channel tool feature can not further be processed in MC_Rack. As a workaround please use filters before applying the channel tool. Always record also the data stream "Electrode Raw Data" to be flexible with analysis options offline.

3.2.6 Monitoring Activity Continuously

Next, you need a **Data Display** for monitoring the ongoing activity continuously.

Click  on the toolbar or click **Add Data Display** on the **Edit** menu to add a **Data Display** to your virtual rack. The **Data Display** displays the channels in the layout of the **Channel Map** you have created or loaded. Channel maps are saved as *.cmp files. The default channel map at first program startup is the 8x8 grid of standard MEAs (saved as 8x8mea.cmp). When you have changed the channel map, the last used channel map is loaded automatically as the default.

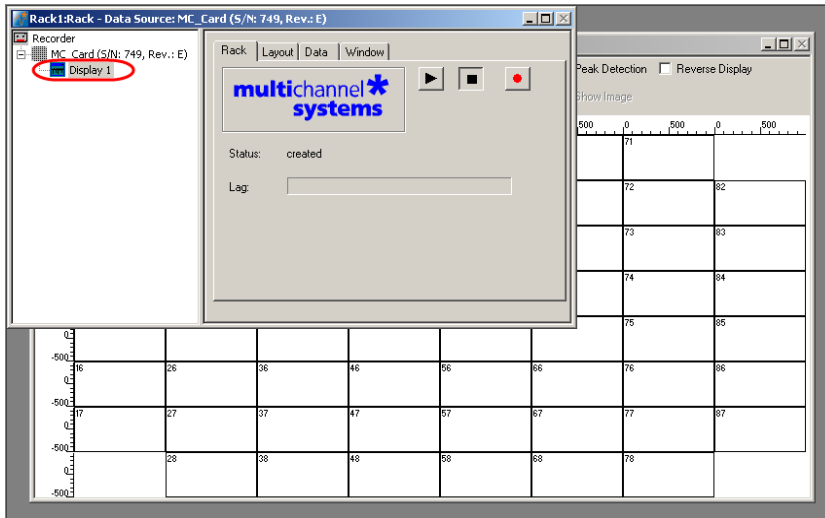

For monitoring the ongoing activity continuously over a longer period, add the **Longterm Display**.

Click  on the toolbar or click **Add Longterm Display** on the **Edit** menu to add a **Longterm Display** to your virtual rack.

The **Longterm Display** shows analog raw data and electrode raw data. You can display data in a user defined time span from 1 second up to 60 minutes. The longterm display tool allows to observe the development of the signals over a longer period. The **Longterm Display** displays the channels in the layout of the **Channel Map** you have created or loaded. In the **Longterm Display** the adjustment of the x-axis is disabled, and you cannot zoom in. The peak detection is permanent selected (for more information please see chapter Peak Detection).

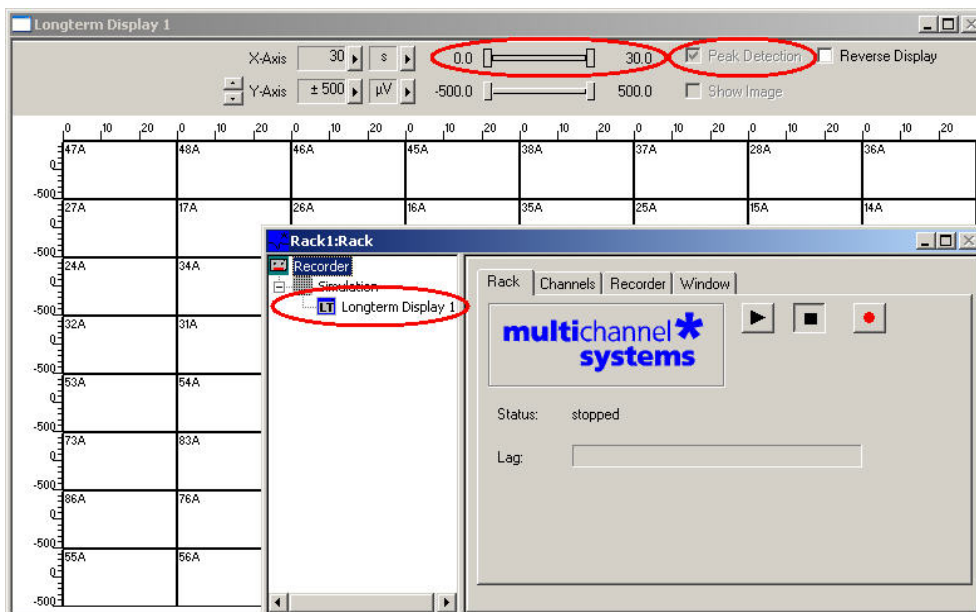

Defining the display layout

Note: You can set up any channel layout that meets your requirements and save it for later use. You can pick preconfigured channel maps for all MEAs available from Multi Channel Systems from the **MCS Channel Maps** drop down list.

1. In the tree view pane of the virtual rack, select the **Display 1** and click the **Layout** tab. You see the currently used display layout of the **Default Map**: The standard 8x8 grid. The electrodes are labeled in relationship to their position in the electrode grid, respectively to their coordinates. The first number refers to the x-axis (column), the second number refers to the y-axis (row). The character refers to the MEA, MEA A in this case, that is important when using more than one MEA amplifier.

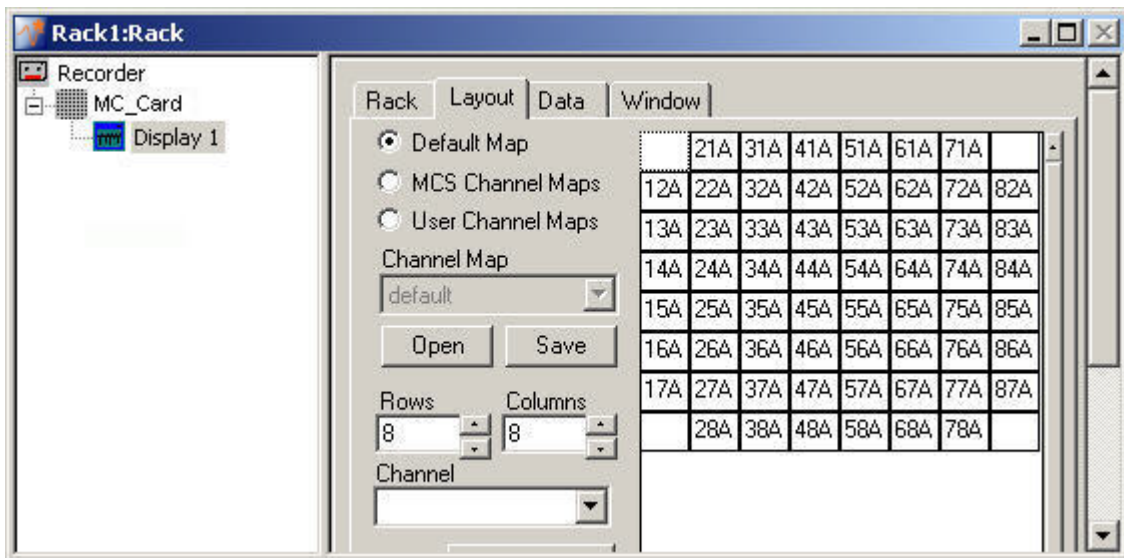

2. To load a different **Channel Map**, click **MCS Channel Maps** or if the channel map is user defined, click **User Channel Maps**. You can use the **Channel Map** drop down menu or you browse your folders and open the MC_Rack program folder. In the **Channel Maps** folder, you will find a selection of standard layouts, for example, for different MEA types, layouts for the MEA two or four fold-systems (8x8meaA.cmp and 8x8meaB.cmp for two or four separate MEAs), and various other layouts for single electrode columns on a MEA, for example. Select an appropriate channel map and click **Open**. The MEA layout appears on the right side of the dialog box and the display shows the channels in the selected layout accordingly.

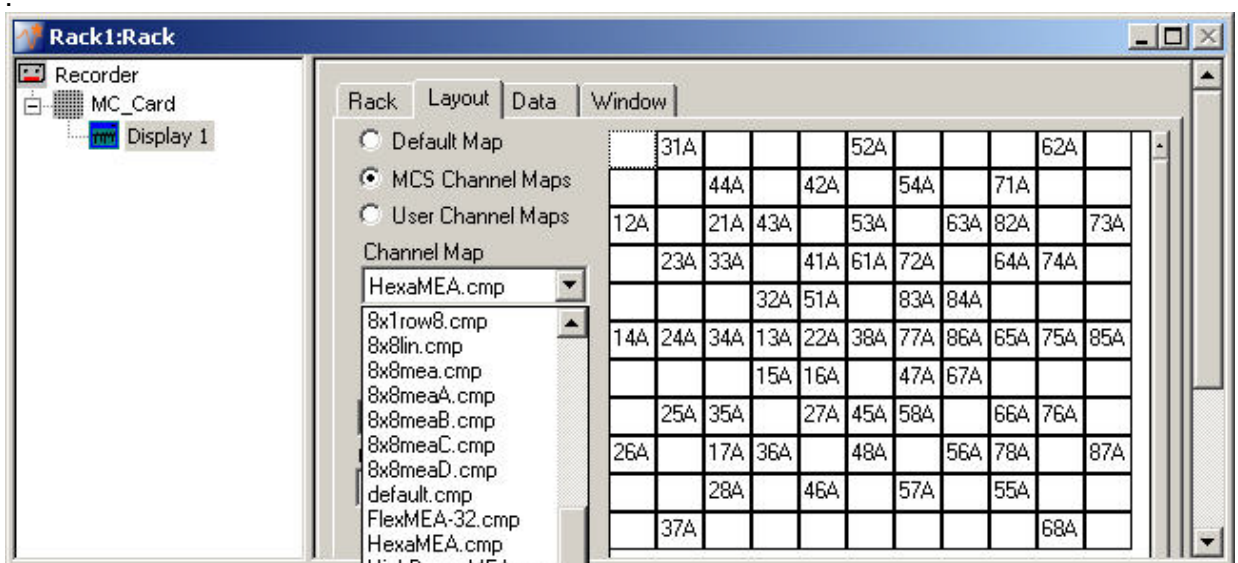

3. For setting up a **custom layout**, enter the desired number of rows and columns. The layout grid displayed on the right is updated accordingly.

MC_Rack Manual

- Click any **electrode number** that you want to change and select the desired channel number from the **Channel** list, or type the channel number with the keyboard.

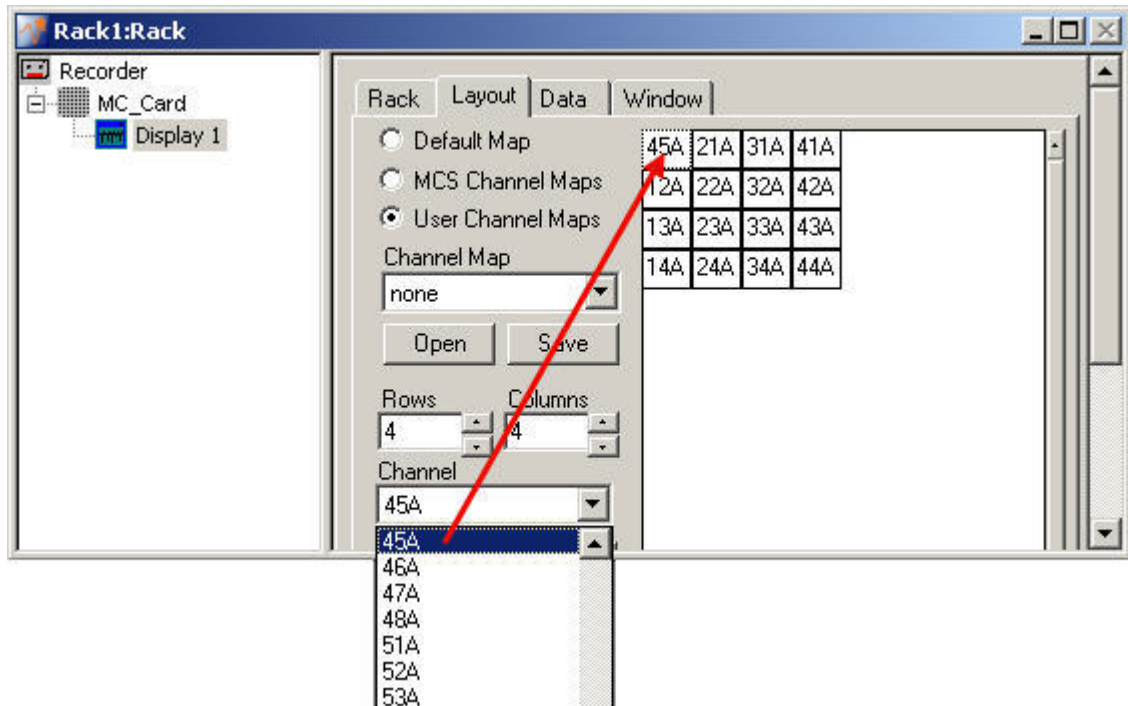

- If you want to keep the custom layout **for later use**, click **Save** and enter a file name.

Option: Advanced

Hint: For advanced users only! Adjusting a custom MEA layout to a custom data display layout.

Click button **Advanced**.

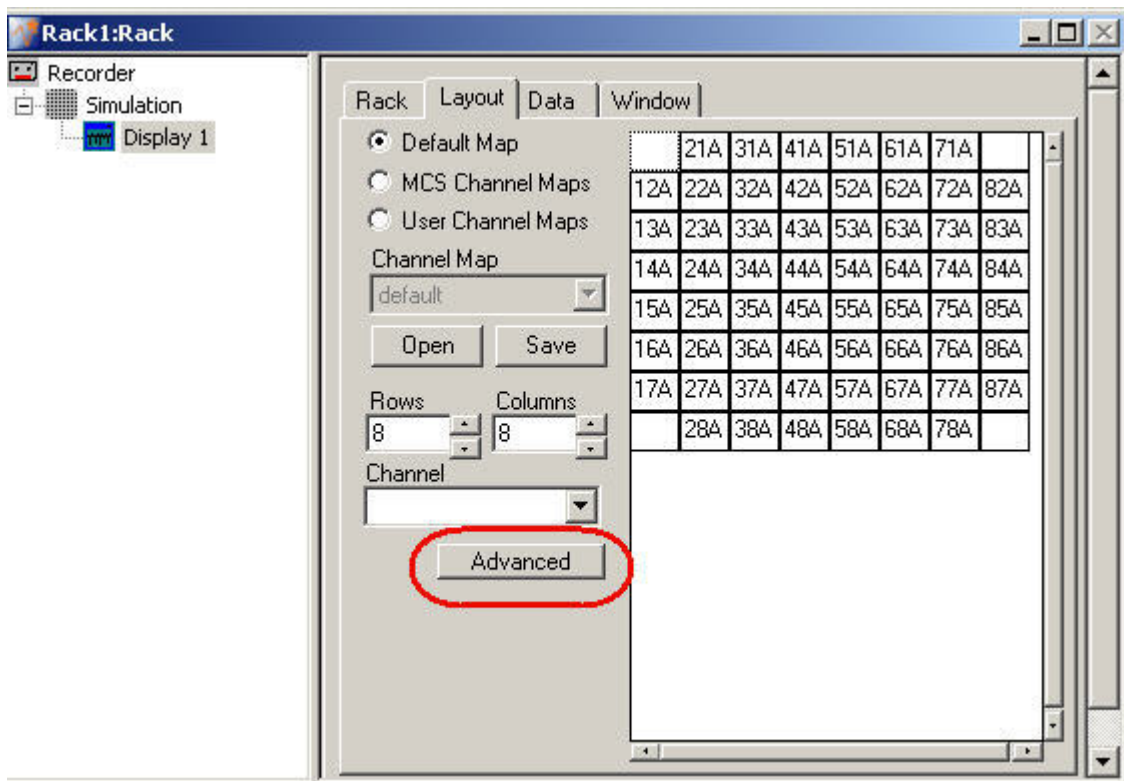

Additional windows appear: Channel Offset, X- and Y- Offset and X- and Y-Extend. These commands concern the data display layout only.

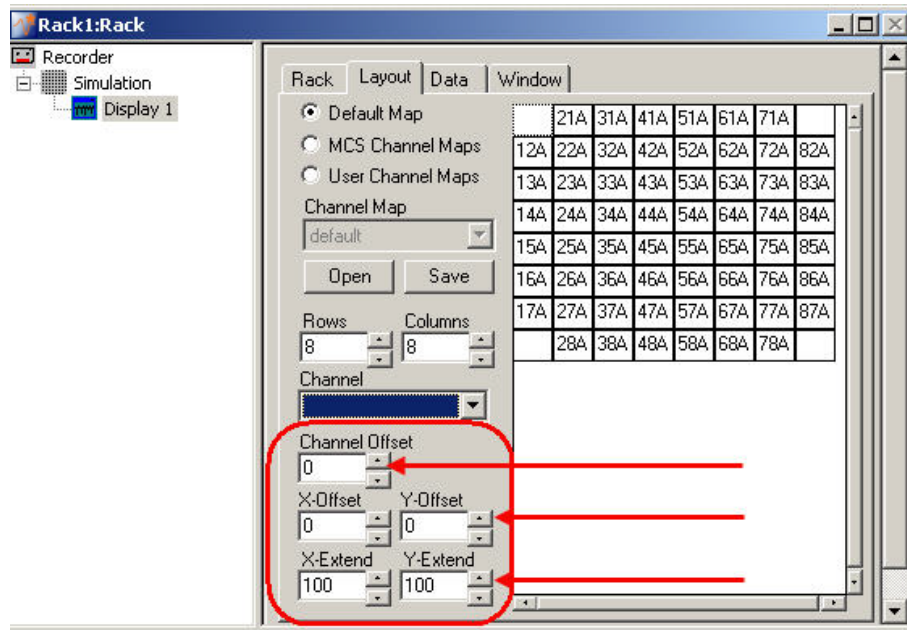

Example: Setting up a MEA layout 5x5 with electrodes in different sizes.

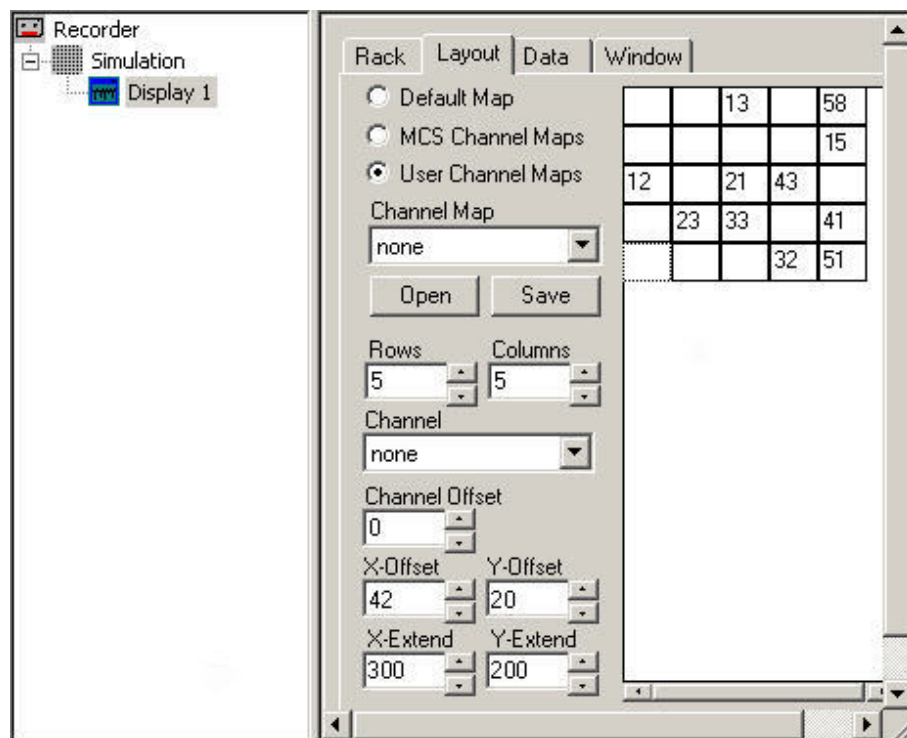

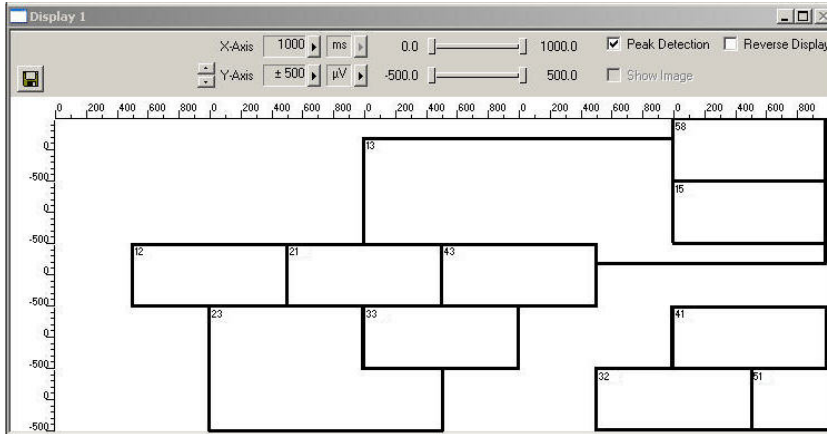

1. Click **User Defined Map**.
2. Set up a MEA layout with a 5x5 grid using **Rows** and **Columns**. The MEA layout appears on the right side of the dialog box and in the data display.
3. Click into the empty squares of the electrode grid and select the desired channel numbers from the **Channel** drop down menu. The data display shows the channels in the selected layout accordingly.
4. The electrode referring to channel No.13 (in the middle of the first row) is bigger than the other electrodes. Click 13 in the electrode grid. Enlarge the electrode in the data display with **X-Extend** = 300 and **Y-Extend** = 200 by overwriting the 0 in the numeric updown box or clicking the arrow buttons.
5. To change the position of the electrode in the data display use **X-Offset** for moving it to the left (negative integer) and to the right (positive integer), and **Y-Offset** for moving it downward (positive integer) and upward (negative integer). The X- and Y-Offset has a range from -100 to +100. Overwrite the 0 in the numeric updown box or click the arrow buttons. The layout displayed on the data display is updated immediately.
6. The electrode referring to channel No. 23 is bigger as well. Do the same procedure to enlarge and move it as described in point 4 and 5. Repeat this procedure as often as necessary, and you are able to build your custom display layout.

If you have two or four amplifiers in your setup use **Channel Offset** to assign the custom layout to the correct data stream. Please read also next chapter "Selecting data streams". Until today, it only makes sense to give 0 in Channel Offset for connecting the custom layout to Electrode Raw Data 1 or 64 for connecting the custom layout to Electrode Raw Data 2.

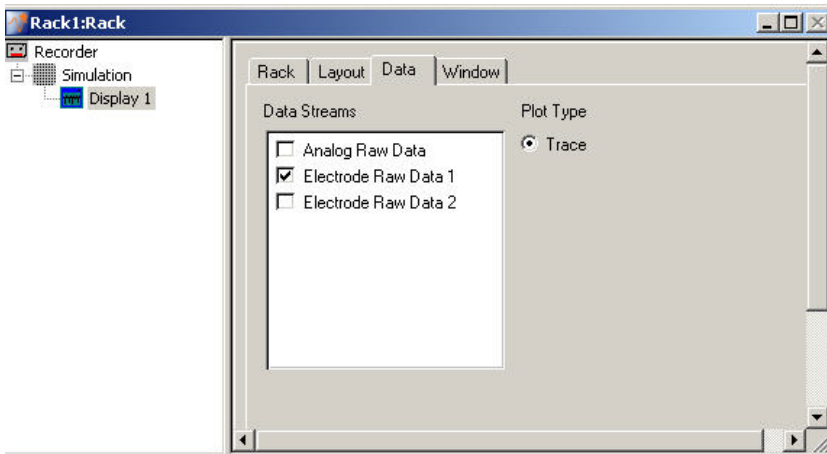

If you want to keep the custom layout **for later use**, click **Save** and enter a file name.

Selecting data streams

1. Click the **Data** tabbed page.
In this page, you select the data streams that you want to monitor in the display. The **Electrode Raw Data** stream is already preselected. You can select the **Analog Raw Data** stream if you have connected a data source to an analog data input (A1 A2 and A3 for the MEA-System). It may make more sense to display the additional analog channels in a separate display, though, because in most cases, the scale of the axes will not be appropriate for both the electrode data stream and the additional analog data stream. For monitoring the digital data stream, please use the **Digital Display**. The **Data Display** has an oscilloscope-like function. Therefore, only the **Trace** option is available. The **Parameter Display** for graphing extracted parameters provides more options.

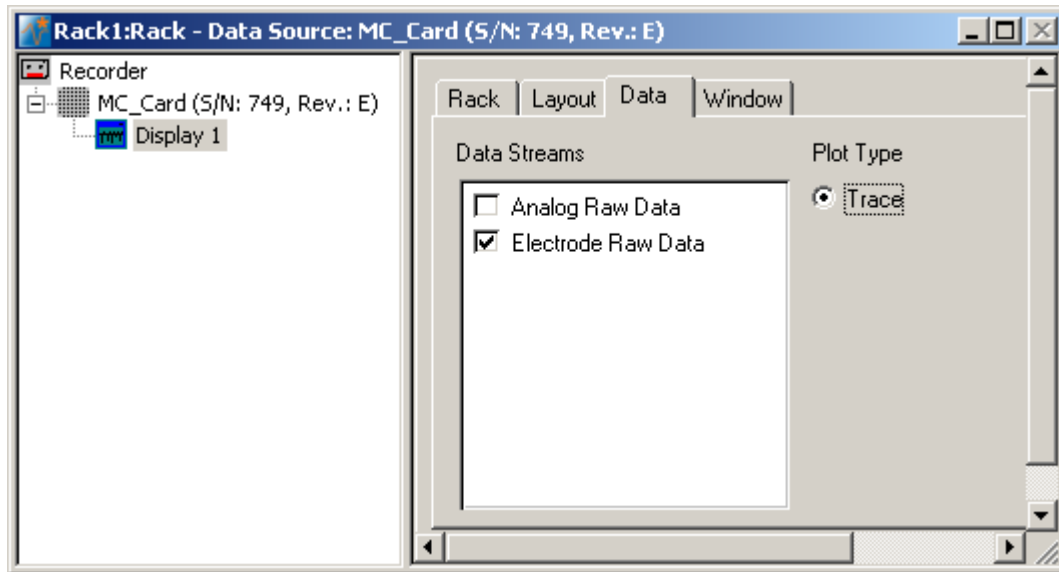

Starting MC_Rack

- Click **Start**  (either on the **Measurement** menu, the toolbar, or the **Rack** tabbed page) to start the data acquisition. Each virtual instrument in the rack starts to process the channels and data streams that were assigned to it, that is, the **Trigger Detector** detects events on the digital input channel and generates a trigger data stream that, in turn, triggers the display. The display is refreshed at each trigger event.

Refresh rate and ranges

1. Switch to the **Display 1** window.
2. You can **zoom in** the signals by choosing the appropriate range of the y-axis from the **Y-Axis drop-down list**, or by clicking the **arrow buttons**.
3. You can select the display **refresh rate** and maximum **x-axis range** from the **X-Axis drop-down list**.
4. You can fine-tune the ranges of the y- and x-axis with the **sliders**.

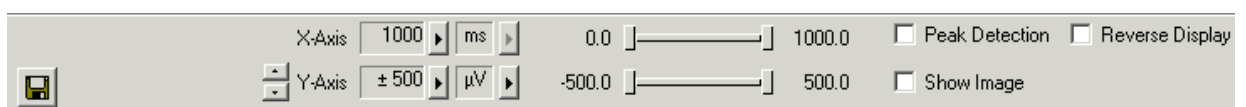

3.2.7 Recording Data

MC_Rack's philosophy is to strictly separate the actions of all virtual instruments in a rack. That means, that you could record to hard disk completely different data streams and channels than you monitor on the screen. This has the advantage that you can store exactly the channels you are interested in, but it also has the slight disadvantage that all virtual instruments have to be set up separately. Please be especially careful when configuring the **Recorder** to avoid data loss.

Selecting data streams and channels for recording

The fate of each single channel is independent from other channels. You can pick exactly the channels you like to save from all generated data streams. For example, you can decide to save only one channel of raw data, but the peak-to-peak amplitude results of all, or of a specific selection of channels.

Select the **Recorder** in the virtual rack tree view pane and then click the Channels tabbed page. On the white pane on the left of the Channels page, you see the data streams that are available with your data source settings, for example, the **Analog Raw Data**, **Digital Data**, and **Electrode Raw Data** streams for the MEA-System. (It does not matter whether you have really connected a device to the inputs, though.) If you have selected a channel layout without the digital input, the **Digital Data** stream will not be available, for example.

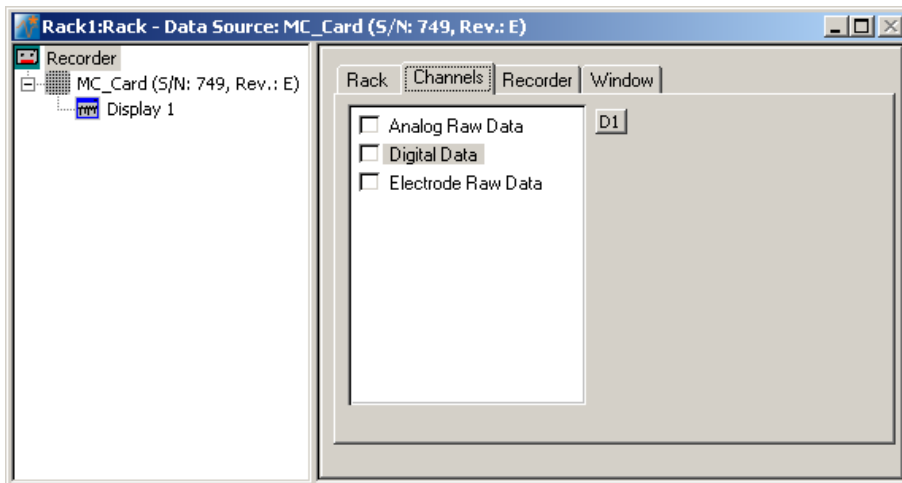

1. Click the data stream that you are interested in, that is generally the **Electrode Raw Data** stream. The available electrode channels appear in a button array on the right side.

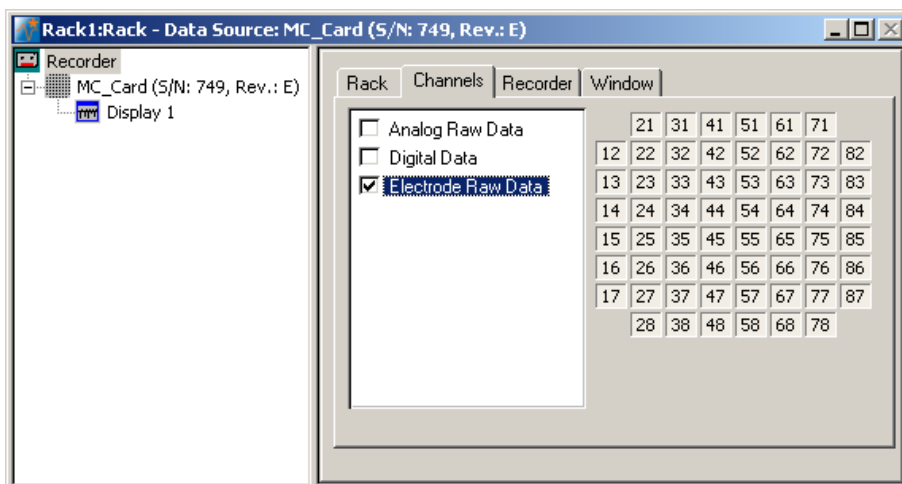

2. You can now either select all channels by clicking the check box next to the Electrode Raw Data stream name, or you can pick single channels by clicking the corresponding buttons. For more information, please see "Channel Selection" in the MC_Rack Features section. Only data from the selected channels will be saved to the hard disk.

Choosing the file name and path

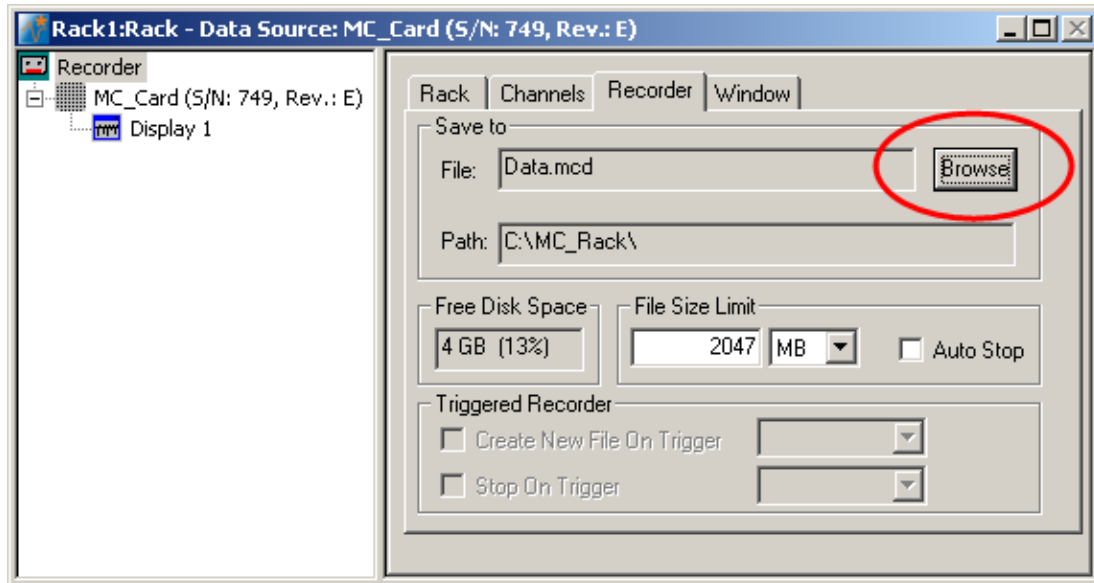

1. Click the **Recorder** tab.
2. **Browse** your folders and select a path.
3. Type a file name into the text box.
4. Confirm by clicking **Save**.

The file extension for the data files is *.mcd.

File size limit

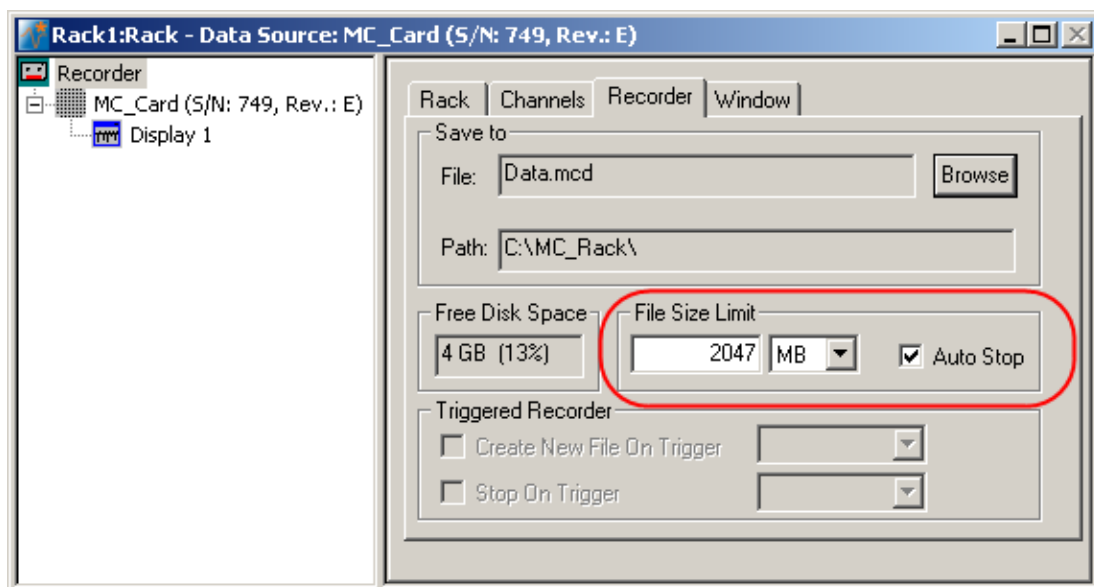

The file size is not limited by default, but the user can limit it. When the maximum file size specified by the user has been reached, a new file is generated automatically. The file name is extended by four digits, counting up, for example, LTP-Parameters0001.mcd, LTP-Parameters0002.mcd, and so on.

If you rather prefer that the recording is completely stopped when a file has reached the maximum size, please select the option **Auto Stop**. For information on more options, please see "Generating Data Files" in the MC_Rack Features section.

Continuous recording versus triggered recording

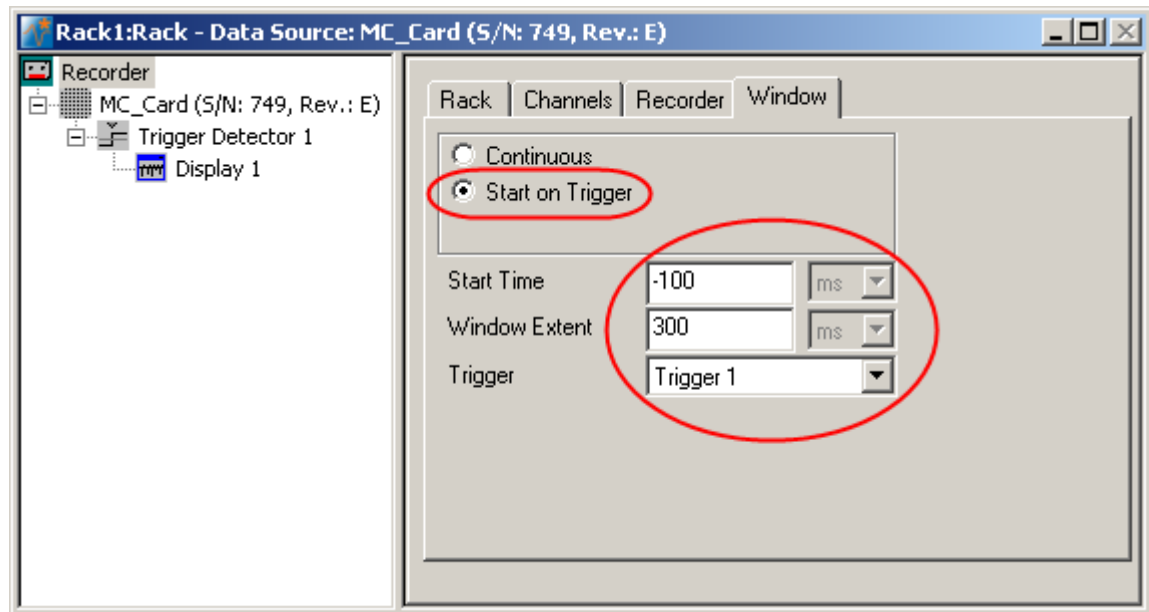

For recording evoked activity, like LTP experiments or retina recordings, it does generally not make much sense to record continuously. It is recommended to record only the signals of interest following a trigger event, for example, a TTL signal from the stimulator, to save disk space. You can then define the **Start Time** (before the trigger event) and the **Window Extent** (total cutout length). Please do not prolong the "Window Extent" time interval to more than 3800 ms. Please read chapter "Triggering MC_Rack on the Stimulus" for more information about "Window Extent" settings. For more information on continuous and triggered data, please see the chapter Continuous and Triggered Data in the "Step by Step Tutorial" section.

This option is only available if there is a trigger stream available, that is, a **Trigger Detector** in the rack.



3.2.8 Starting Data Acquisition and Recording

Now that you have completed the virtual rack, you are ready to start the rack.

- Click **Start**  (either on the **Measurement** menu, the toolbar, or the **Rack** tabbed page) to start the data acquisition. Each virtual instrument in your rack starts to process the channels and data streams that were assigned to it.
- Click first **Record**  and then **Start**  to write data to the hard disk. The data from the electrodes selected in the **Recorder** is saved to the file and location specified in the **Recorder**.

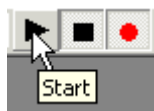

- Click **Stop**  to stop the data acquisition.



Warning: **Only** data of the channels and data streams that were **selected** in the **Recorder** are saved in your data file when you start a recording. Data is **only** saved to the hard disk when the red **Record** button is pressed **in**. Make always sure that you have selected all channels of interest, and that the **Record** button is active before starting an experiment to avoid data loss.

3.3 Monitoring and Recording Triggered Activity

3.3.1 Triggering MC_Rack on the Stimulus

When recording evoked responses, such as in a LTP or PPF experiment, you usually want to synchronize the data displays and the recording to the electrical stimulation. For this purpose, you can feed in TTL pulses to the digital input bits of the digital input channel. In the standard configuration, three BNC sockets are available for applying up to three separate trigger pulses. You can upgrade the system with a digital IN / OUT expansion that support all 16 digital input (and output) bits that are provided by the data acquisition device. For more information, see the ME- or MEA-System manual.

Note: It is recommended to use the digital input port for feeding in TTL signals. The analog inputs are intended for analog signals, like patch clamp data, for example.

For triggering MC_Rack, we need to set up a **Trigger Detector** in the virtual rack. The trigger stream generated by the Trigger Detector can then be used for triggering Data Displays, Analyzers, and the Recorder.

See also the sample rack **Display_Triggered.rck**.

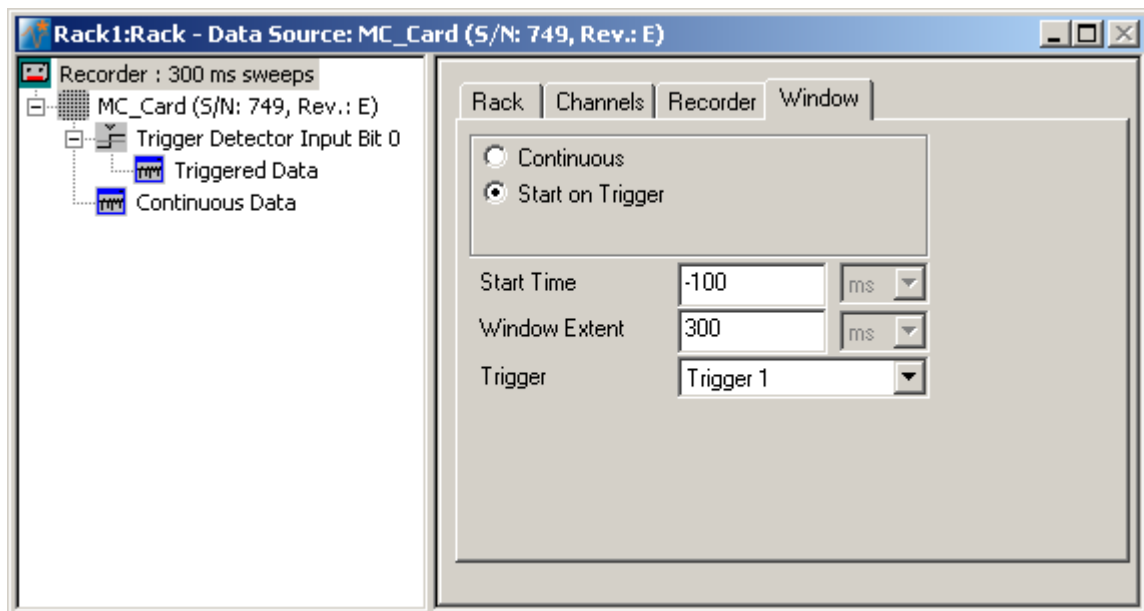

1. Configure your stimulator to output a TTL pulse that is synchronized to the stimulus pattern. If you are using a Stimulus Generator (STG) from MCS, you can program a Sync Out channel.
2. Connect the TTL output to digital input bit 0 (the first BNC socket). If you are using a MEA-System, make sure not to confuse the digital inputs with the analog inputs.
3. Click  on the MC_Rack toolbar to add a **Trigger Detector** to the virtual rack.
4. In the tree view pane of the virtual rack, select the Trigger Detector, and click the Trigger page.

From the **Channel** list, select the **Digital Data D1** channel.

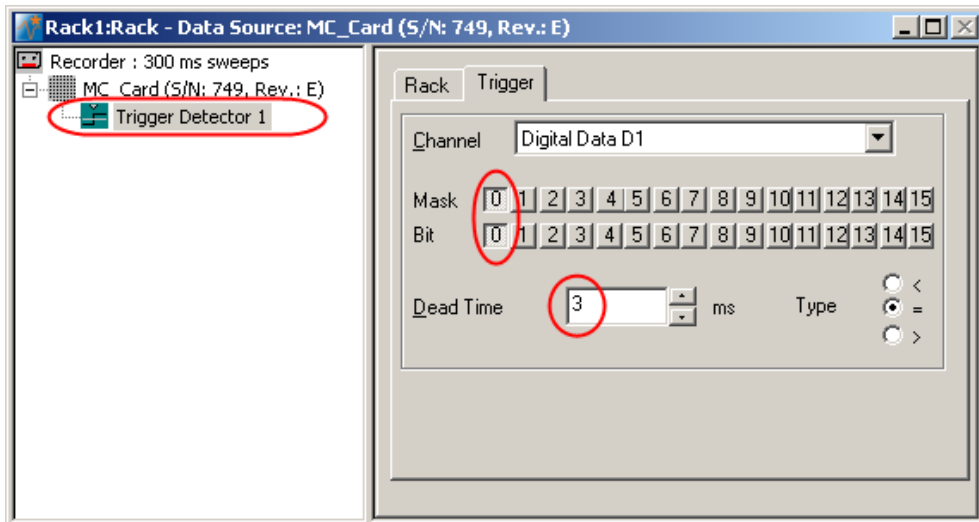

A button array appears, one button for each digital input bit. With the **Bit** button, the logical state (generally HIGH) that generates a trigger event is selected. With the **Mask** buttons, you can select the bits that you want to use; all unused bits are masked.

The digital **input bit 0** is already preselected. The logical state that generates a trigger event is set to **HIGH**. This is fine and you do not need to change it. (If you had, for example, connected the TTL output to digital input bit 1, you would need to select 1 instead of 0, and mask all other bits.) You may want to change the dead time (the time after a trigger event where no following trigger event is accepted), for example, if you run a paired pulse protocol, and want to trigger MC_Rack only on the first stimulus pulse.

Click Recorder and select "Window" tab.

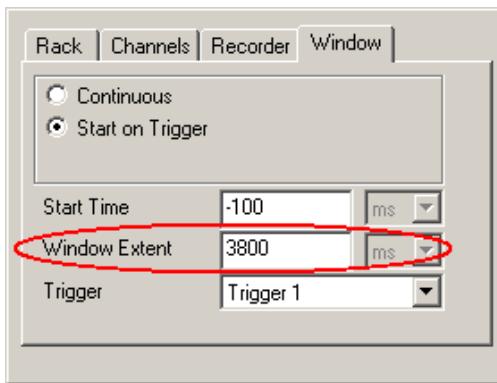

Important: The "**Window Extent**" is the total time of the cutout sweep. If you prolong the trigger in "Window Extent" to more than 3800 ms, a **Warning** will pop up. MC_Rack will record data, but you cannot display these data when replaying them, because the MC_Rack display setting for displaying sweeps is maximal 3800 ms. Please record the sweeps in MC_Rack, but export the data with MC_DataTool to custom ASCII import programs, for example to Matlab, for further analysis.

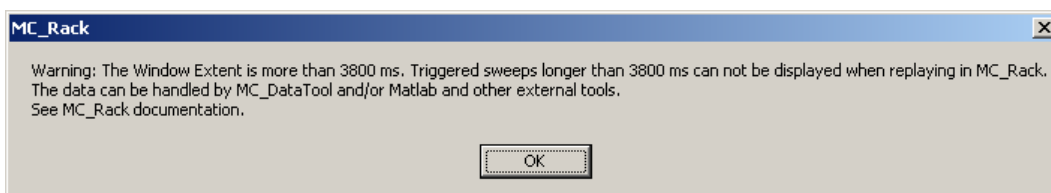

After recording long sweeps with "Window Extent" settings near to 3800 ms, and replaying the respective *.mcd file with the MC_Rack Replayer, please slow down the "Replay Speed" in the "Replayer" tab. Otherwise MC_Rack might have problems with displaying the data.

3.3.2 Monitoring Triggered Activity

Next, you need a **Data Display** for monitoring the ongoing activity.

Click  on the toolbar or click **Add Data Display** on the **Edit** menu to add a **Data Display** in **series** with the **Trigger Detector** to the virtual rack. (If you would put both instruments in parallel, you would not be able to use the trigger stream generated by the **Trigger Detector** for triggering the **Data Display**, because virtual instruments can only use the output streams of other virtual instruments that are upstream in the virtual rack tree.)

The **Data Display** displays the channels in the layout of the **Channel Map** you have created or loaded. Channel maps are saved as "*.cmp" files. The default channel map at first program startup is the 8x8 grid of standard MEAs (saved as 8x8mea.cmp). When you have changed the channel map, the last used channel map is loaded automatically as the default.

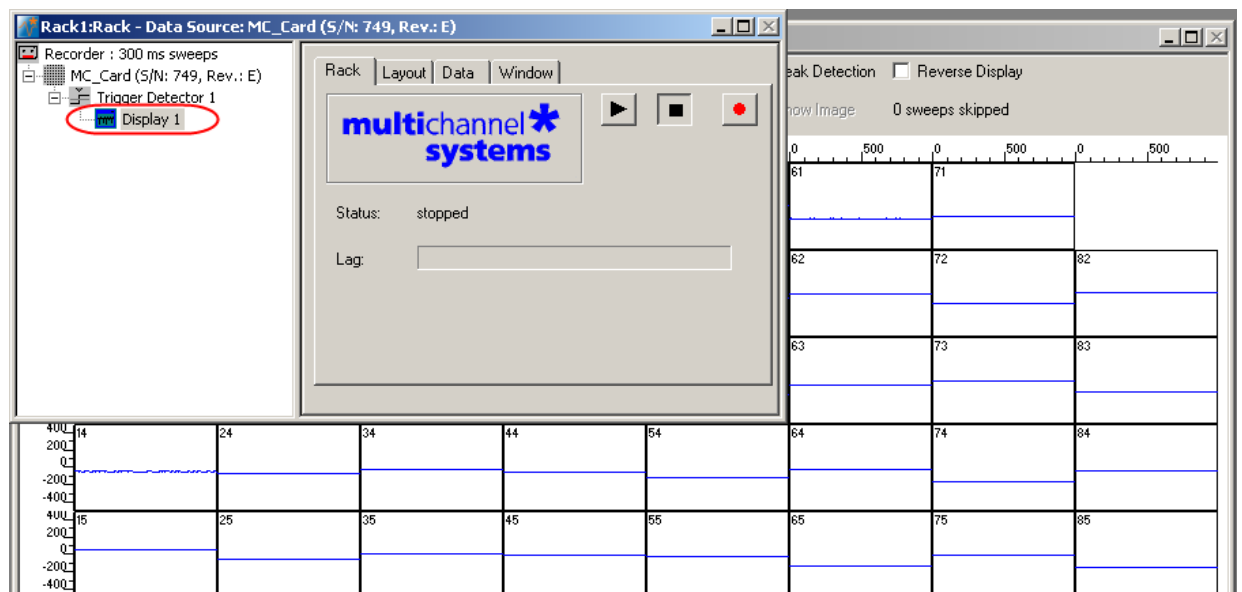

1. Define the display layout and select the data stream as explained before.

Triggering the display

To graph the sweeps synchronized to the stimulation, you need to start the display on the trigger event generated by the **Trigger Detector** that we set up earlier.

1. In the tree view pane of the virtual rack, select the **Display 1**, and click the **Window** tab.
2. Select the option **Start on Trigger**.
In the **Trigger** selection box, **Trigger 1** appears automatically. It is the only trigger data stream available in this rack. (You could set up multiple **Trigger Detectors** and trigger multiple displays on separate trigger events.)

Starting MC_Rack

- Click **Start**  (either on the **Measurement** menu, the toolbar, or the **Rack** tabbed page) to start the data acquisition. Each virtual instrument in the rack starts to process the channels and data streams that were assigned to it, that is, the **Trigger Detector** detects events on the digital input channel and generates a trigger data stream that, in turn, triggers the display. The display is refreshed at each trigger event.

Adjusting the ranges

1. Switch to the **Display 1** window.
2. You can **zoom in** the signals by choosing the appropriate range of the y-axis from the **Y-Axis drop-down list**, or by clicking the **arrow buttons**.
3. You can select the maximum display **refresh rate** and maximum **x-axis range** from the **X-Axis drop-down list**.
4. You can fine-tune the ranges of the y- and x-axis with the **sliders**.

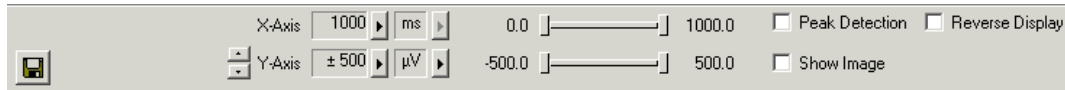

3.3.3 Recording Triggered Data

MC_Rack's philosophy is to strictly separate the actions of all virtual instruments in a rack. That means, that you could record to hard disk completely different data streams and channels than you monitor on the screen. This has the advantage that you can store exactly the channels you are interested in, but it also has the slight disadvantage that all virtual instruments have to be set up separately. Please be especially careful when configuring the **Recorder** to avoid data loss.

In principle, you could record the evoked responses continuously, and trigger the displays and analyzers when you replay the data. However, you would produce a huge amount of useless data, as generally only the response following the stimulus is of interest. Therefore, it is recommended to produce **triggered data**, that is, to cut out sweeps around the trigger event. This saves a lot of disk space.

Selecting data streams and channels for recording

The fate of each single channel is independent from other channels. You can pick exactly the channels you like to save from all generated data streams. For example, you can decide to save only one channel of raw data, but the peak-to-peak amplitude results of all, or of a specific selection of channels.

Select the **Recorder** in the virtual rack tree view pane and then click the Channels tabbed page. On the white pane on the left of the **Channels** page, you see the data streams that are available with your data source settings, for example, the **Analog Raw Data**, **Digital Data**, **Electrode Raw Data**, and **Trigger** streams. (It does not matter whether you have really connected a device to the inputs, though.)

Click the data stream that you are interested in, that is generally the **Electrode Raw Data** stream, and the **Trigger** stream. The available electrode channels appear in a button array on the right side.

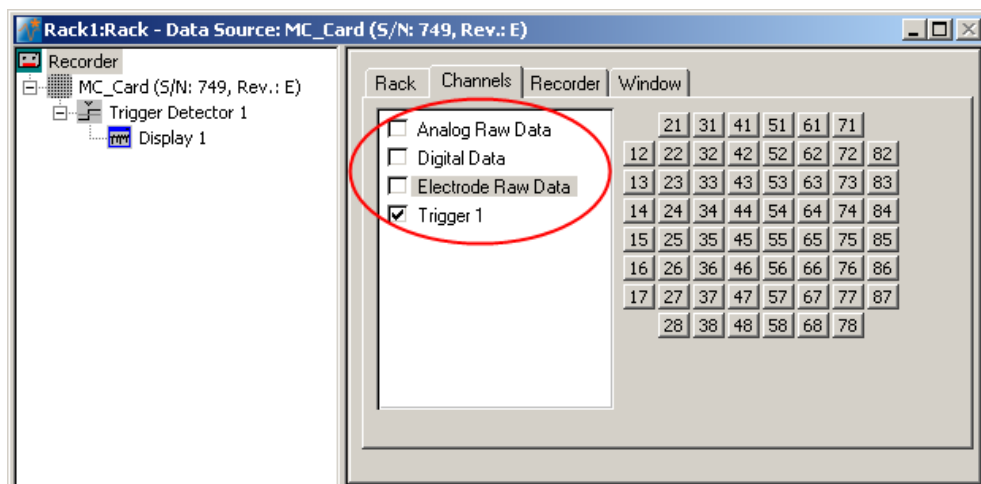

1. You can now either select all channels by clicking the check box next to the Electrode Raw Data stream name, or you can pick single channels by clicking the corresponding buttons. For more information, please see "Channel Selection" in the MC_Rack Features section. Only data from the selected channels will be saved to the hard disk.

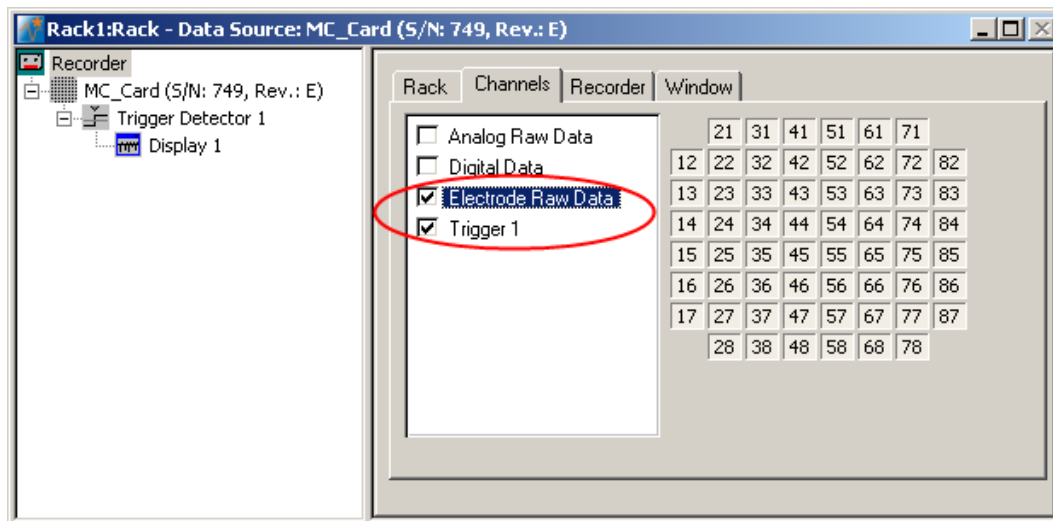

Choosing the file name and path

1. Click the **Recorder** tab.
2. **Browse** your folders and select a path.
3. Type a file name into the text box.
4. Confirm by clicking **Save**.

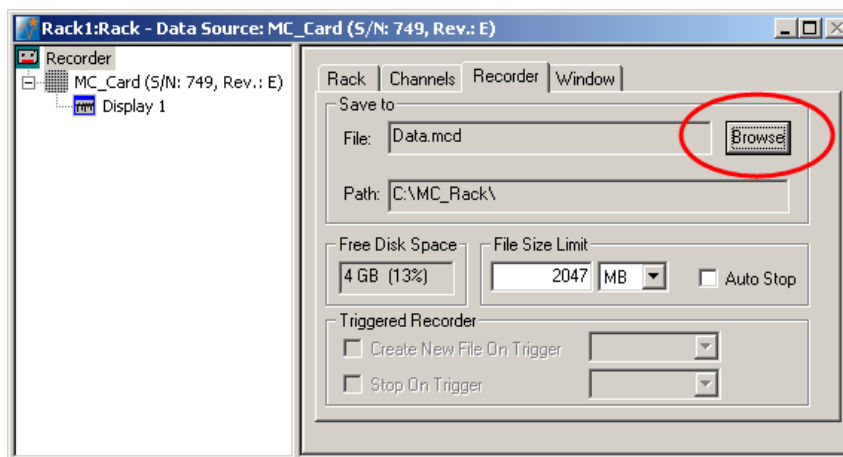

The file extension for the data files is *.mcd.

File size limit

When the maximum file size specified by the user has been reached, a new file is generated automatically. The file name is extended by four digits, counting up, for example LTP-Parameters0001.mcd, LTP-Parameters0002.mcd, and so on.

If you rather prefer that the recording is completely stopped when a file has reached the maximum size, please select the option **Auto Stop**.

For information on more options, please see "Generating Data Files" in the MC_Rack Features section.

Triggering the recording

Again, the displayed data is independent from the recorded data. Thus we need to start the recording on the trigger event generated by the **Trigger Detector** in the same manner as we triggered the display.

This option is only available if there is a trigger stream available, that is, a **Trigger Detector** in the rack.

1. In the tree view pane of the virtual rack, select the **Recorder**, and click the **Window** tab.
2. Select the option **Start on Trigger**. In the **Trigger** selection box, **Trigger 1** appears automatically. Two text boxes appear, too. These two parameters define the cutout: The **Start Time** is generally a negative value, that is, the pretrigger time. The **Window Extent** is the total time of the cutout sweep. Please read chapter "Triggering MC_Rack on a stimulus" for more information about "Window Extent" settings.

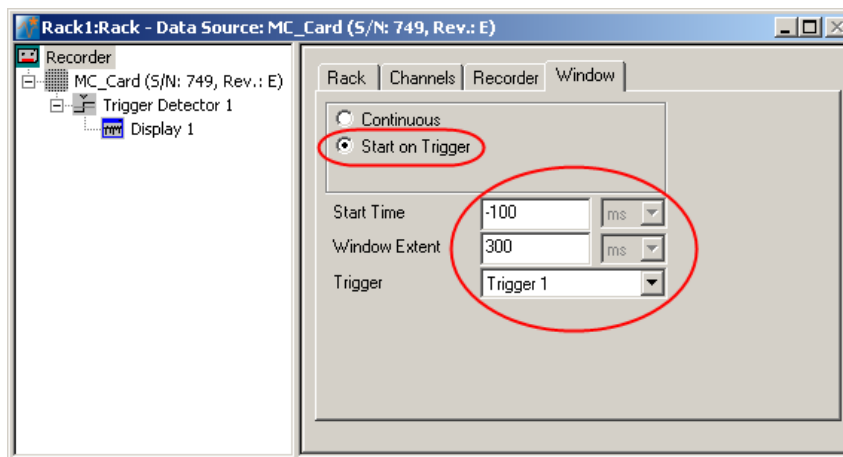

3.4 MEA2100-System

3.4.1 MEA2100-System

Specific Functions of the MEA2100-System

The following chapter summarizes all functions and settings of MC_Rack which are specific for the MEA2100-System. You will find the identical information in several subchapters of the MC_Rack manual and in the manual of the MEA2100-System.

MEA2100-System Configuration

The MEA2100-System is a flexible system, which can be used in different configurations. Please read the MEA2100-System manual for detailed information. At the moment five types of headstages are available for the MEA2100-System, which can be connected to the interface board once or twice: A headstage for one MEA with 32 (MEA2100-HS32), 60 (MEA2100-HS60) or 120 electrodes (MEA2100-HS120), and headstage for two MEAs with 32 (MEA2100-HS2x32) or 60 electrodes each (MEA2100-HS2x60). One or two headstages can be connected to the interface board (IFB) of the MEA2100-System.

MEA2100-32-System

The MEA2100-32-System is a system providing all functions of a MEA2100-System, with the exception of the real-time feedback via DSP. In "Data Source Setup" it is present as an own device "MEA2100-32". Please read the MEA2100-System manual for detailed information.

Using MC_Rack Software

Data Source Setup

Every MEA of the system can be operated completely independently by one instance of MC_Rack. To be able to open more than one instance of MC_Rack, please first open the "Advanced Configuration" dialog in the "Edit" menu.

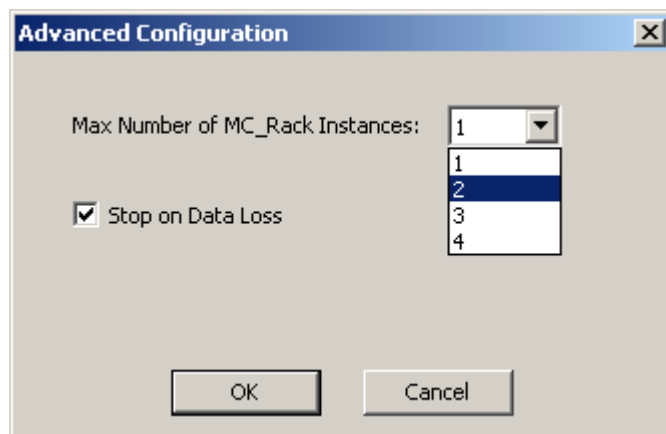

Please increase the maximum number of instances according to the number of MEAs you are going to use in parallel:

- one MC_Rack instance for one HS32, HS60 or one HS120,
- two MC_Rack instances for one HS2x32, HS2x60, or for two HS32, HS60 or two HS120,
- four MC_Rack instances for two HS2x32 or HS2x60.

Afterwards you can open several instances of MC_Rack and assign every instance to one MEA of the system.

MC_Rack Manual

After opening MC_Rack as many times as necessary, please open the "Data Source Setup" dialog from the "Edit" menu. This dialog can only be opened in one instance at a time, please do the adjustments in one instance after the other. The example below shows the settings for one MEA2100-HS2x60.

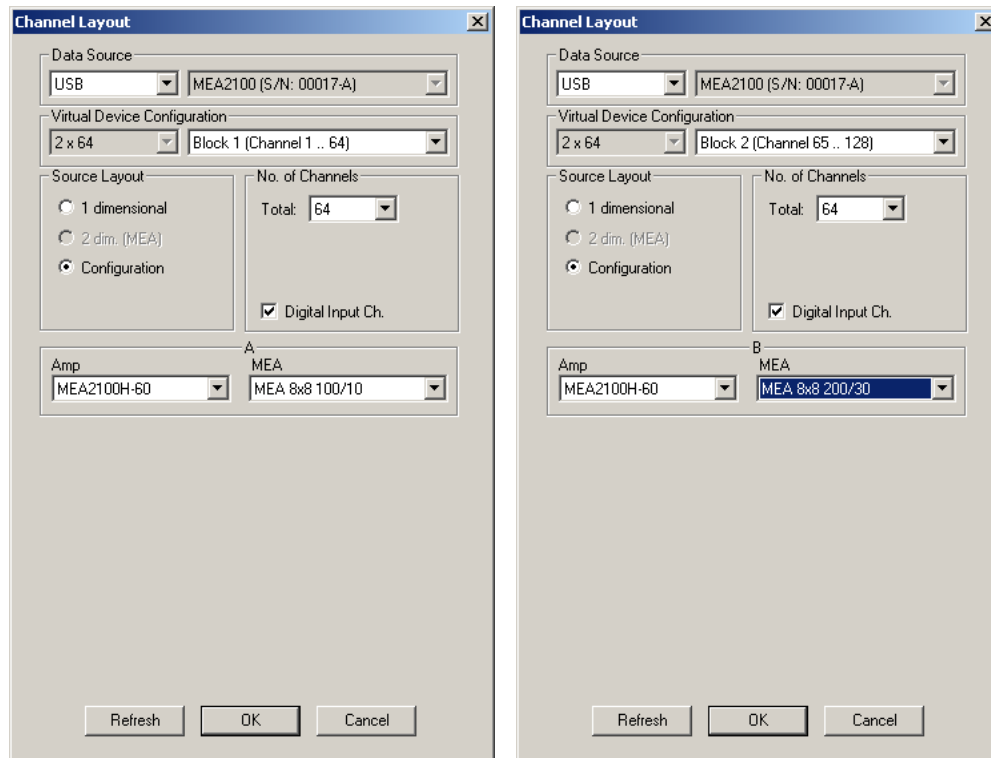

Select "USB" and MEA2100 (S/N: XXXXX-A) as Data Source. Select "Configuration" in the "Source Layout". Please select the type of the connected headstage in the "Amp" drop down menu.

If a MEA2100-HS2x60 is connected you have additionally to select the "Block" in the right drop down menu of "Virtual Device Configuration". For the first instance of MC_Rack, select Block 1 (Channel 1...64) and for the second instance Block 2 (Channel 65...128). Select the appropriate MEA type from the drop down menu for each instance. If a second headstage is connected to the same interface board, it will become available in the "Data Source Setup" as MEA2100 (S/N: XXXXX-B). The settings for the second headstage are analog to the first.

Hardware Settings for the MEA2100-System in the Data Source

When using the MEA2100-System, the "Hardware" tab of the MC_Rack software is modified. Please see also chapter "Defining a Data Source".

In the "Hardware" tab of the Data Source, the gain setting must be adjusted to ensure a correct scaling of the data in MC_Rack. The gain is a fixed hardware property, while sampling frequency and input voltage range of the data acquisition board can be selected according to the demands of the experiment.

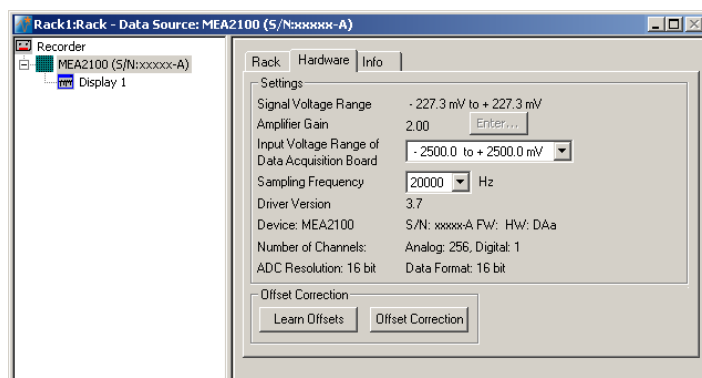

The appropriate "Amplifier Gain" factor of the MEA2100-System will automatically be entered. Depending on the hardware revision the MEA2100-System the gain factor is 5, in older revisions factor 2.

The "Input Voltage Range of Data Acquisition Board" divided by the gain is the "Signal Voltage Range", the maximum size of signals you can record before they get clipped. Please adjust the "Input Voltage Range of Data Acquisition Board" according to the expected size of your signals. It is advisable to select the input voltage range as small as possible, to ensure an optimal A/D resolution of the analog input signals.

The ADCs (Analog Digital Converter) of the MEA2100 system have a resolution of 24 bit, the MC_Rack software can record and display data with a resolution of 16 bit. To handle the complete 24 bit range, the input voltage range selection in the MC_Rack software can select a window of 16 bit out of these 24 bits, resulting in the following signal ranges:

+/- 812 μ V; +/- 1727 μ V, +/- 3545 μ V; +/- 7090 μ V;

+/- 14 mV; +/- 28 mV, +/- 57 mV; +/- 114 mV; +/- 227 mV

A smaller input range results in a better resolution in bits/ μ V, signals larger than the selected range will be clipped. In summary, the procedure has exactly the same functionality as a software selectable gain, even though, strictly speaking, it is not.

The "Sampling Frequency" should also be selected as low as possible, depending on the signals you like to measure, to minimize data file size.

If several instances of MC_Rack are used to operate the MEA2100-System, for example with a MEA2100-HS2x60 headstage or two MEA2100-HS120 headstages, each instance of MC_Rack operates independently; you can define the "Input Voltage Range of Data Acquisition Board" and the "Sampling Frequency" for each instance of MC_Rack individually.

Hardware Filter Settings

While the MEA2100-System in principle can measure DC signals, this is for most purposes very impractical, as the baseline would constantly drift. Therefore the system is equipped with software configured hardware filters. By default, a second order high pass filter with a cut off frequency of 1 Hz is used to prevent a baseline drift. The upper cut off frequency is 3.3 kHz. Additionally you can use the software filters of MC_Rack, if necessary.

Note: To change the filter settings you can use the add on software "MEA2100 Configuration".

Setting up the Internal Stimulus Generator of the MEA2100-System

The headstage of the MEA2100-System is equipped with an integrated 3-channel stimulus generator.

Even when using multiple instances of MC_Rack, each instance is completely independent and each instance has three stimulus channels available for the electrodes which are controlled by that instance.

It is possible to choose between current or voltage controlled stimulation, and any electrode can be selected for stimulation. The control functions for electrode selection and definition of the stimulation parameters are integrated into MC_Rack, you do not need any additional software. However, it is possible to import stimulation patterns generated in MC_Stimulus II as ASCII data.



Important: In current stimulation mode, if you select two or more stimulation electrodes for the same stimulation pulse, please be aware that in some configurations (when more than one electrode is used within a block of 30 electrodes which are powered by the same current source) the current level of the stimulation pulse will be divided among these electrodes. That means the current level is lower than expected. Please read also chapter "Stimulation" in the Appendix.

MC_Rack Manual

Add the internal stimulus generator to your rack: Click menu "Edit" and choose "Add MEA2100 Stimulator".

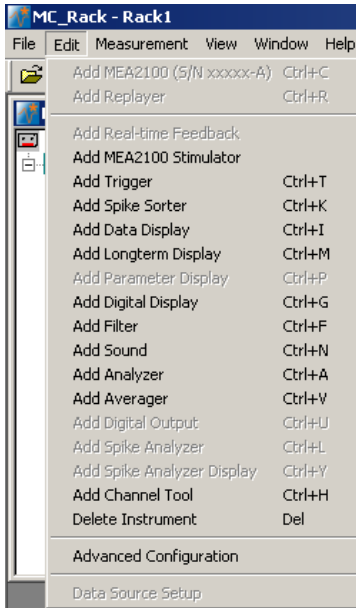

The following dialog appears.

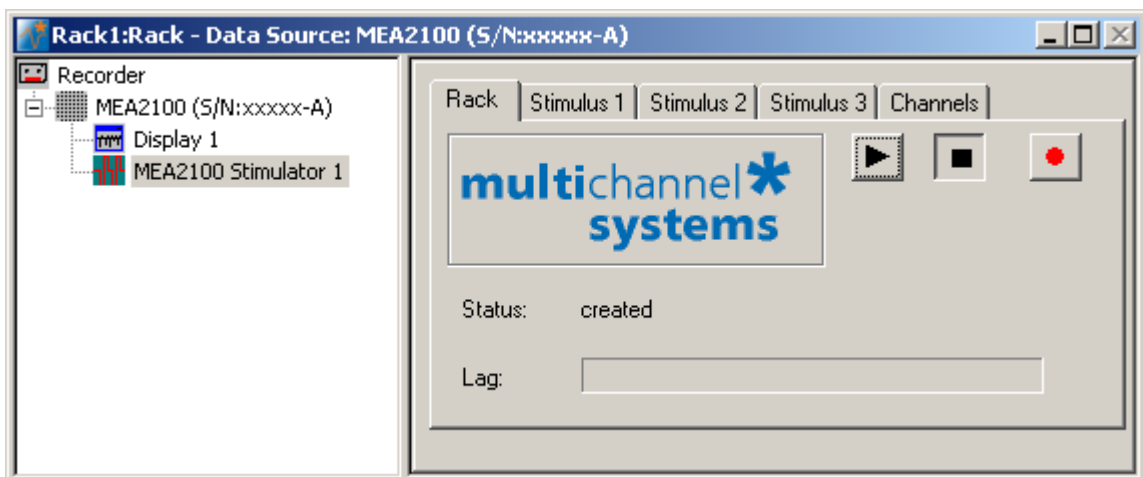

Select the tab of any of the three stimulation channels (Stimulus 1, 2 or 3). In the "Stimulus" tab page, you can define the stimulation pulse and select how the stimulation is started and stopped.

Click "Stimulus 1" tab page, for example.

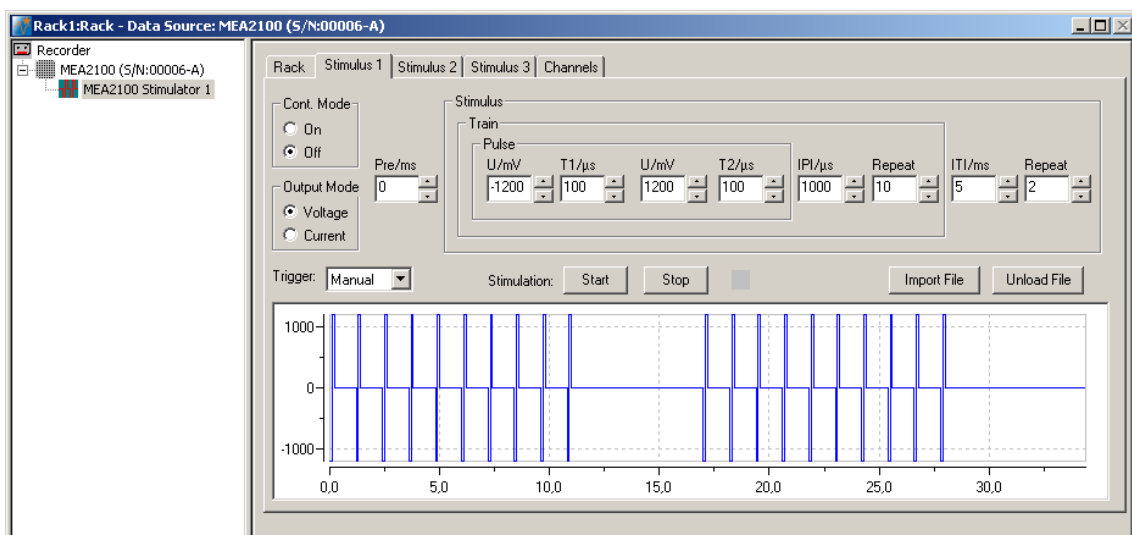

Defining the stimulation pulse

In "Output Mode" you can choose whether you want to stimulate in voltage or current mode. To set up the stimulus pulse or pulse train, please use the eight provided up down boxes.

The screenshot shows a software window titled "Stimulus". Inside, there is a "Train" section which contains a "Pulse" sub-section. The "Pulse" sub-section has eight input fields with up/down arrows: U/mV (1600), T1/μs (100), U/mV (-1600), T2/μs (100), IPI/μs (1000), Repeat (10), ITI/ms (1000), and Repeat (1).

The individual stimulation pulse is defined in the "Pulse" window. Set up a monophasic pulse by selecting the voltage / current in mV/μA and the duration time T1 in μs. For setting up a biphasic pulse you have to select the stimulation strength and time also for the second phase. The shape of the pulse is displayed immediately in the window below. Once started, a programmed paradigm will run to its' end, or till it is manually terminated.



Warning: Anodic (positive) pulses can lead to a formation of titanium oxide on the MEA electrodes. When using MEA electrodes of TiN material, use only negative voltages pulses or biphasic current pulses applying the negative phase first. Always regard the safe-charge injection limits. Otherwise, electrodes can be irreversibly damaged by electrolysis.

When using the "Train" window for setting up a pulse train, please select the "Inter Pulse Interval IPI" in μs and the number of pulses in the train in "Repeat". If no pulse train is needed, set the IPI to zero and the Repeat to one.

The "Inter Train Interval ITI" function can be used to repeat a single pulse or a pulse train.

The interval time can be set in ms, and also the number of repeats. The complete programmed paradigm is shown in the graphical display below the stimulus window.

Once started, a programmed paradigm will run to its' end, or till it is manually terminated.

If the "Continuous Mode" is activated, the paradigm will be repeated indefinitely, till manually stopped. Please note that stimulation does not stop when MC_Rack is stopped.

The screenshot shows a control panel titled "Cont. Mode". It contains two radio buttons: "On" (which is selected) and "Off".

Importing a stimulation file created with MC_Stimulus II

To generate more complex stimulation patterns it is possible to import a stimulation file setup with the MC_Stimulus II software as ASCII data. Please read the respective stimulus generator STG manual for detailed information about creating a stimulus file. You can import any pulse type available in MC_Stimulus II.

- Program the file in MC_Stimulus II as usual; channel 1 will become stimulus 1 in MC_Rack, channel 2 will become stimulus 2, and channel 3 will become stimulus 3.
- Export the file as ASCII file (MC_Stimulus II: File - Export ASCII)
- Import this file in MC_Rack (Stimulus Tab: Import File)

It is not necessary to program Sync Out pulses. Information in MC_Stimulus Channel 4 and up all Sync Out channels will be ignored.

MC_Rack Manual

The "Stimulus" interface will be disabled and the imported pattern will be shown in the graphical stimulus display. To skip the imported pattern and reactivate the "Stimulus" interface, click the "Unload File" button.

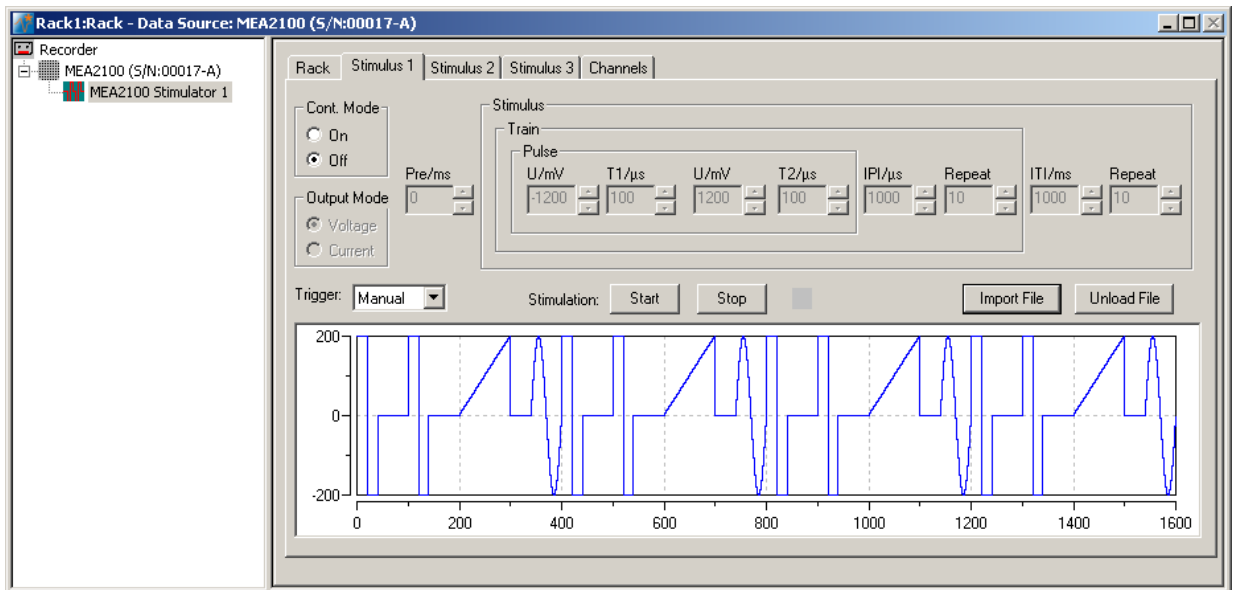

Starting and stopping the stimulation

In the "Trigger" drop down menu it is possible to choose different types of triggers to start the stimulation. The LED next to the Start / Stop button indicates the status of stimulation; the LED turns orange when the stimulation is running, the LED turns grey when the stimulation is stopped.

Important: MC_Rack must **not** be running in "Play or Record" mode to be able to start a stimulation paradigm, but a running paradigm will continue even after MC_Rack is stopped. Once started, a programmed paradigm will run to its' end, or till it is manually terminated.

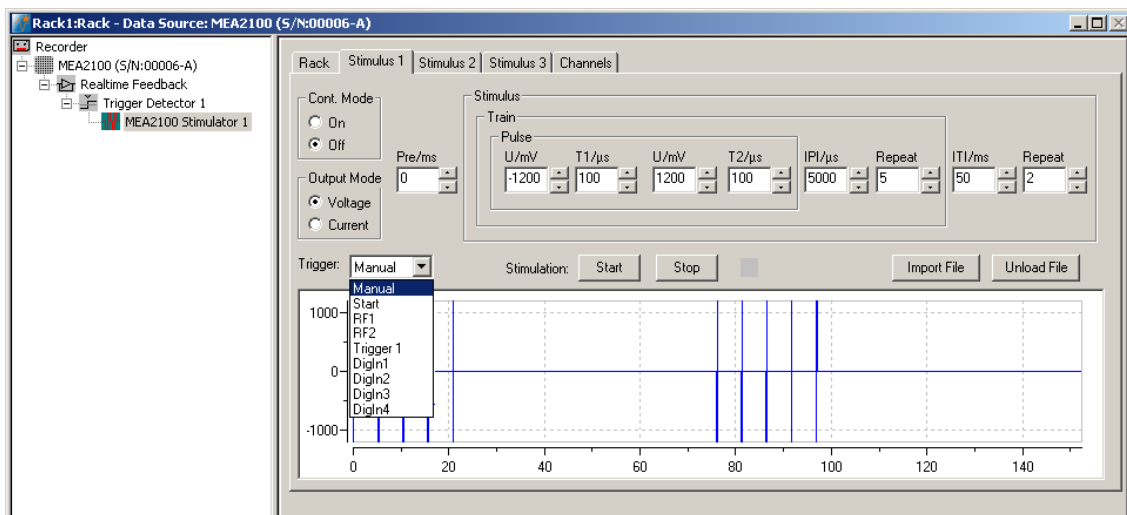

If "Manual" is selected in the "Trigger" drop down menu, the "Start" and "Stop" buttons can be used to control the stimulation manually.

If "Start" is selected, the stimulation starts as soon as MC_Rack is started (in "Play" or "Record" mode). A delay between start of MC_Rack and start of stimulation in ms can be selected in the "Pre" time window. You can stop the stimulation paradigm by pressing the "Stop" button.

If a "DigIn" is selected, the stimulation starts if a TTL pulse is delivered to the respective connectors Digital In 1 to 4 on the front of the MEA2100-System interface board.

If the internal STG is connected to one or more "Trigger Detectors" in the MC_Rack virtual tree, it is also possible to start the stimulation on any of these Triggers (Trigger 1, 2 ...).

If the “Real-time Feedback” tool is activated, any of the internal STG can be started on one of the conditions defined in the Real-time Feedback tool (RF1, RF2, ...). Please see chapter “Real-time Feedback with MEA2100-System” for more information. The tool must be present and active, for the Real-time Feedback conditions to become available.

If a new trigger arrives before the programmed stimulation paradigm is finished, the paradigm starts again from the beginning. All three stimulus channels can be started and stopped independently.

To repeat a stimulation pulse in a loop, activate the “Continuous Mode”. The pulse will be applied continuously until it is stopped by manually with the “Stop” button.

Selection of stimulation electrodes

Click the “Channels” tab to assign the programmed stimulation patterns to individual electrodes, and to activate the blanking circuit BC, and to operate the “List Mode”.

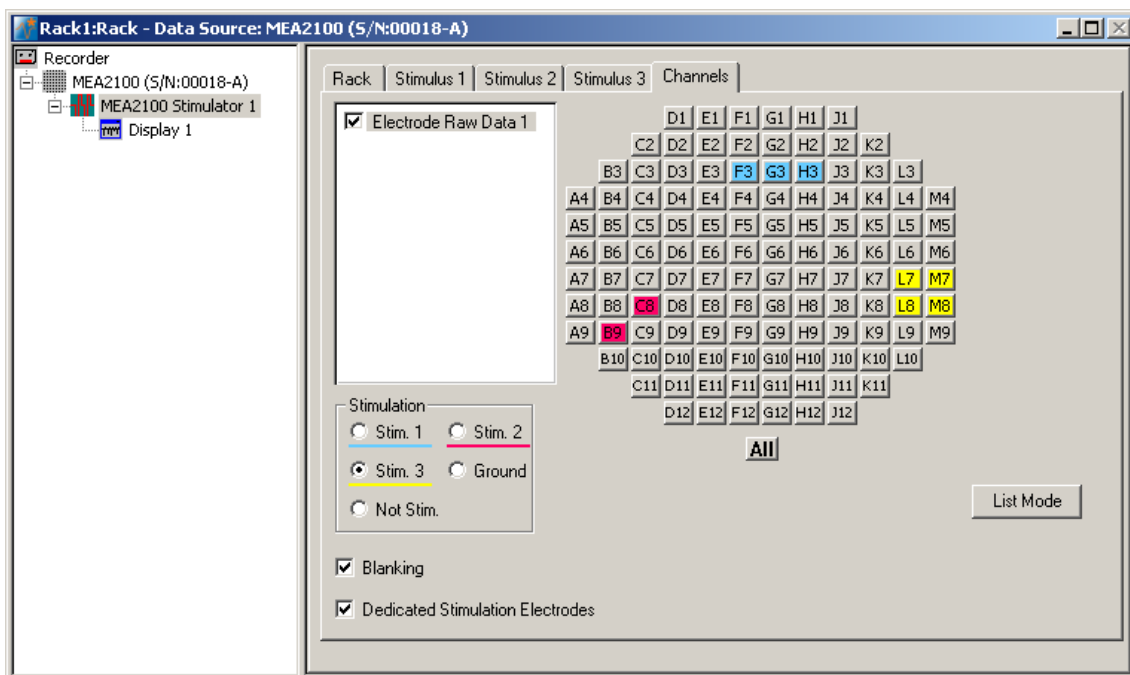

To apply the stimulation pattern of a specific stimulation channel (Stim. 1, 2 or 3) to one or more electrodes, select the desired stimulation channel (Stim. 1 to 3) and click the electrodes you want to apply this paradigm to. To apply the stimulation pattern to all electrodes, click the button “All” below the grid. Electrodes can be grounded or selected as regular recording electrodes (Not Stim.) in the same way.

Electrodes selected for stimulation pattern 1 “Stim.1” are colored in blue, for stimulation pattern 2 “Stim. 2” are colored in red, or stimulation pattern 3 “Stim. 3” are colored in yellow. To cancel a stimulation electrode, please use the radio button “Not Stim.” and click on the selected electrode.

Blanking

The blanking feature to avoid stimulation artifacts can be activated or deactivated via the check box “Blanking”.

A blanking signal transiently switches off the input stage of the amplifier during the stimulus, thus avoiding stimulus artifacts on non-stimulating electrodes.

Amplifier saturation is effectively prevented and the recovery time is greatly reduced. During the blanking period, a flat line is displayed. This blanking period extends a few hundred microseconds before and after the actual stimulus, currently 600 μ s, but might be subject to change. The pre- and post-time are experimentally optimized and can not be changed by the user.

Dedicated Stimulation Electrodes

The function “Dedicated Stimulation Electrodes” can be used to further avoid stimulation artifacts on the electrodes surrounding the stimulation electrode which are sometimes not completely removed by the blanking alone. Usually, the stimulation electrode will be connected to the stimulator output only during the stimulation pulse, and afterwards be switched back to the amplifier to be used as recording electrode. This sometimes causes switching artifacts independently from the actual stimulation.

However, if the function “Dedicated Stimulation Electrodes” is active, the selected stimulation electrodes will be constantly connected to the stimulator outputs. This causes permanent higher noise on the selected stimulation electrodes, and makes of course recording on the stimulation electrodes impossible, but almost completely removes residual artifacts. The images below show stimulation on electrode F3 with and without “Dedicated Stimulation Electrodes” activated.

Note: The artifact suppression additional to blanking via “Dedicated Stimulation Electrodes” is not available when using the “List Mode”.

“Dedicated Stimulation Electrodes” selected (X-Axis: 1000 ms, Y-Axis: +/- 500 µV)

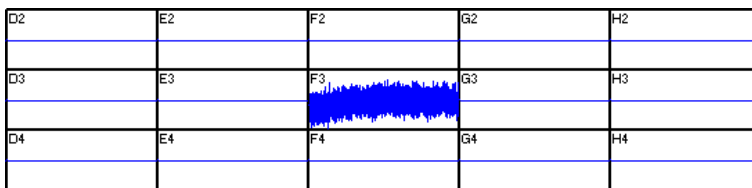

“Dedicated Stimulation Electrodes” deselected (X-Axis: 1000 ms, Y-Axis: +/- 500 µV)

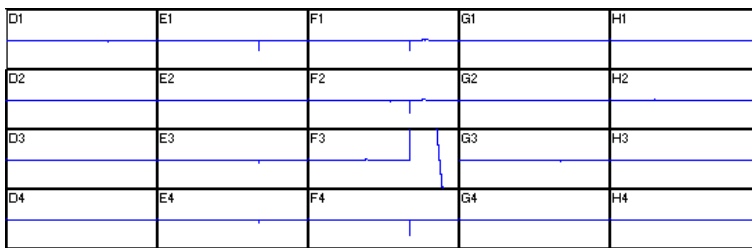

List Mode

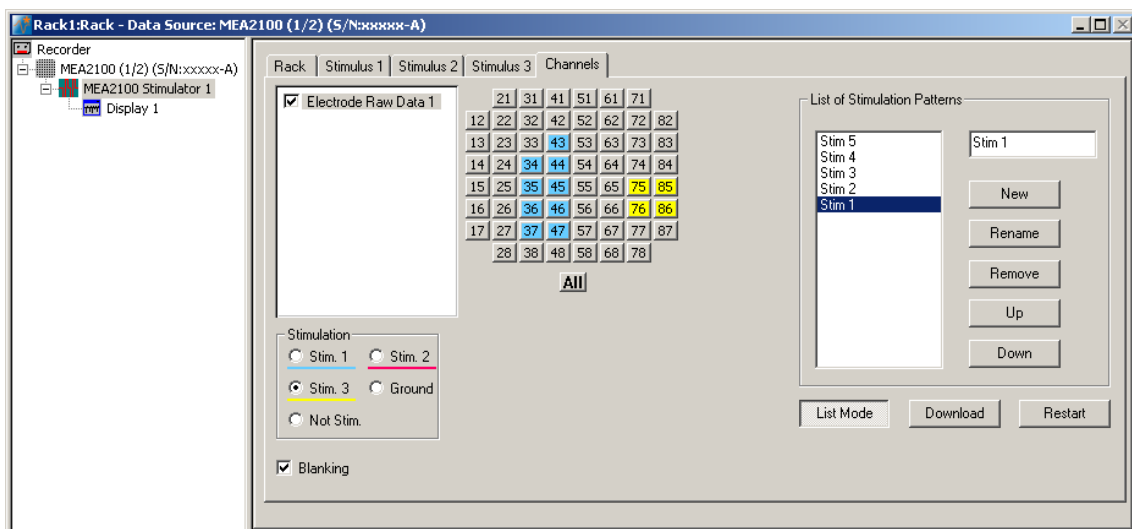

Clicking the button **List Mode** opens an additional window: **List of Stimulation Patterns**. In **List Mode** it is possible to generate and download a list of up to 256 user defined stimulation patterns, which will then be applied automatically one after the other.

When the List Mode is activated, the three stimulator units are **coupled to a single starting trigger**. The starting trigger is set in the tab of the first stimulator unit, Stimulus 1. In Stimulus 2 and 3, the respective functions are disabled. To uncouple the stimulator units again, close the List Mode dialog. The step from one stimulation pattern to the next in the list happens when the start condition defined for Stimulus 1 occurs (for example, manual start, incoming trigger, real-time feedback trigger) **and** all three stimulator units are idle. Please see the red bars on the picture. However, the next pattern can only be started by the respective starting condition when the previous stimulation paradigm, including all breaks, is completely finished.

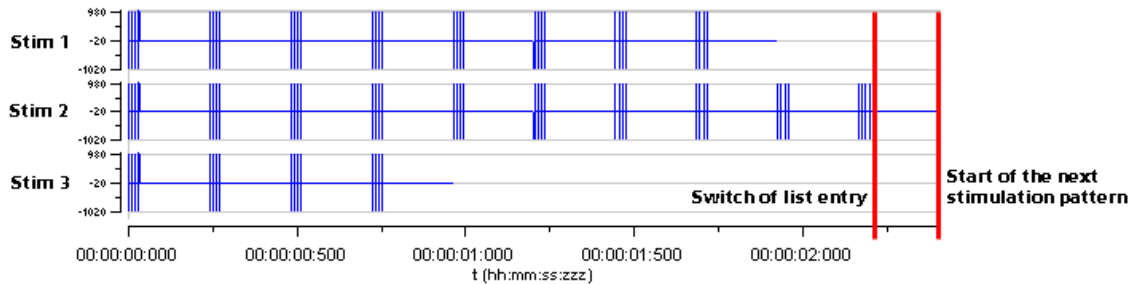

That means, if one stimulation pattern of any of the three stimulator units is still running when the condition occurs, nothing will happen. This also holds true when a stimulator unit is not actually used in the currently active stimulation pattern.

Hence, the **longest** programmed stimulation pattern determines the minimum possible time between two starting triggers, even if the respective stimulator unit is not actually used. It is therefore advisable to set a stimulation pattern with a length of 0 on all unused stimulator units, and keep all patterns as short as possible.

A stimulation pattern can contain single or multiple stimulation electrodes and may get an user defined name. To create a list of different stimulation patterns, please do the following.

Click the button "List Mode". There are two windows in the "List of Stimulus Pattern". The small window on the right side is for typing in a name for a pattern. In the window on the left side the list of stimulation pattern will be displayed and arranged.

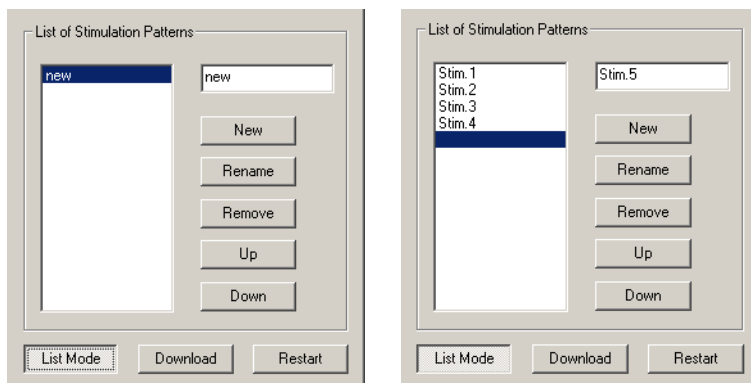

When opening the "List Mode" for the first time, the term "New" appears and the current stimulation pattern is the first stimulation pattern in the list. To change the name, please overwrite the name with the specific name of this pattern in the small window.

To insert a stimulation pattern, select with the mouse the position in the list where you want to place the pattern. The line will be highlighted in blue. Type the specific name of this pattern in the small window. Click the button "**New**" and the new list entry appears.

To append a pattern, select the line under the last list entry. The line will be highlighted in blue. Type the specific name of this pattern in the small window. Click the button "**New**" and the new list entry appears.

To rename a pattern of the list, select the pattern which will be highlighted in blue. Then you can change the name of the pattern in the list. Please click the "**Rename**" button.

MC_Rack Manual

The command **“Remove”** eliminates the pattern in the list, which is highlighted in blue. With **“Up”** or **“Down”** you can move the patterns to arrange them in that sequence you like to apply them.

Click **“Download”** to download the list of stimulation patterns to the internal stimulus generator of the MEA2100 headstage.

To start the stimulation patterns in the list mode, please use the **“Trigger Start”** in **“Stimulus 1”** tab of this dialog. The trigger start in Stimulus 2 and Stimulus 3 tab will not be available, but all three triggers run simultaneously.

The stimulation patterns from the list will be applied one after the other and change every time the start condition defined for Stimulus 1 occurs and all three stimulator units are idle, as described above. When the end of the list is reached, the software jumps back to the first pattern and continues. When the **“Restart”** button is pressed, the software jumps to the first entry in the list, respectively.

Use of the Digital Channel in the MEA2100

In contrast to the other MEA- and ME-Systems from Multi Channel Systems, the 16 input bits of the digital channel are not all accessible for external trigger signals, but are mostly used for internal communication between the different components of the MEA2100 system. Only the first four bits are connected to the physical DigIn connectors on the front side of the MEA2100 interface board. Most bits are permanently assigned to certain functions. However, these settings can be customized if necessary. Please see the channels assignments from the following table.

Bit 0	DigIn 1	Digital In channel 1
Bit 1	DigIn 2	Digital In channel 1
Bit 2	DigIn 3	Digital In channel 1
Bit 3	DigIn 4	Digital In channel 1
Bit 4	Stimulus 1	Stimulation pattern on channel 1
Bit 5	Stimulus 2	Stimulation pattern on channel 2
Bit 6	Stimulus 3	Stimulation pattern on channel 3
Bit 7	Zero	not connected
Bit 8	RF 1	Real-time feedback specification 1
Bit 9	RF 2	Real-time feedback specification 2
Bit 10	RF 3	Real-time feedback specification 3
Bit 11	RF 4	Real-time feedback specification 4
Bit 12	RF 5	Real-time feedback specification 5
Bit 13	RF 6	Real-time feedback specification 6
Bit 14	RF 7	Real-time feedback specification 7
Bit 15	RF 8	Real-time feedback specification 8

To monitor the digital data stream you can use the "Digital Display" tool. If a MEA2100 device is connected, the input bits will be labeled according to their function in the digital display.

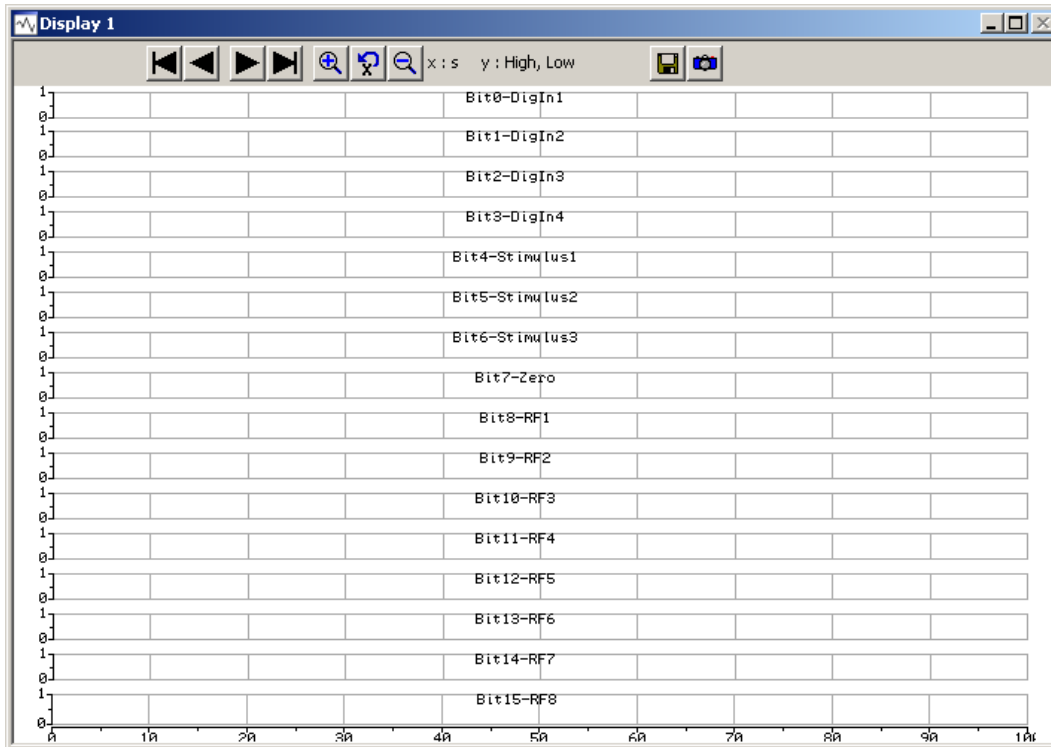

If a **MEA2100-32** device is connected, the "Real-time feedback" is not available, respectively the real-time feedback specification 1 to 8 are not available. Therefore the input bits are used for the digital inputs, bit 0 to bit 12 to digIn 1 to 13. The stimulation channels are connected to the last three bits, bit 13 to stimulus 1, bit 14 to stimulus 2 and bit 15 to stimulus 3. The channels are labeled according to their function in the digital display.

To record the digital data stream in the data file, please enable the respective check box in the "Channels" tab of the Recorder tool.

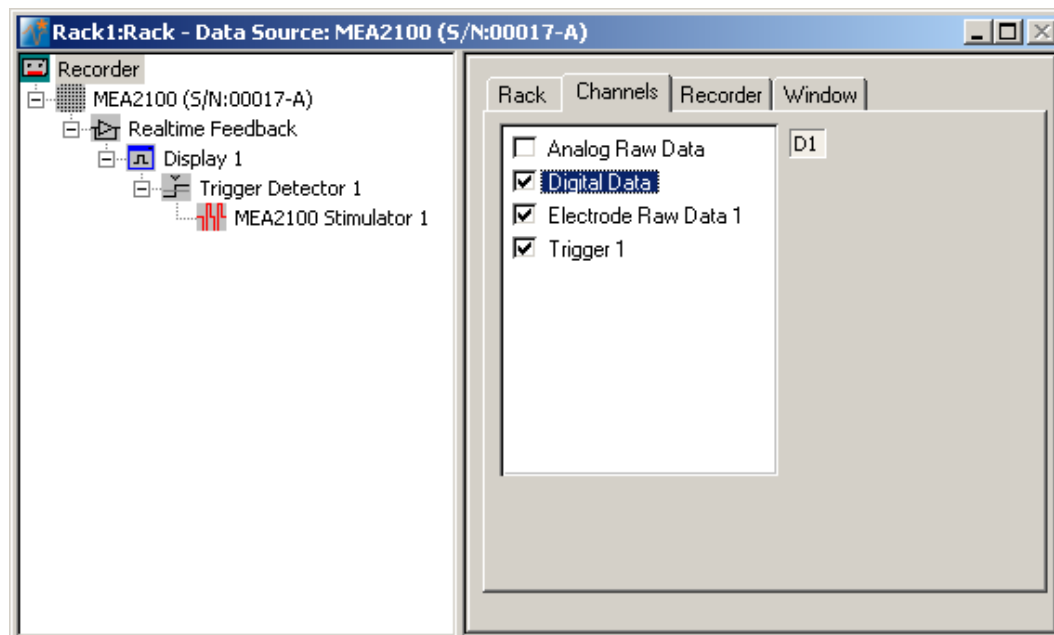

Triggering on Stimulation Pulses from Internal STGs

It is possible to trigger on stimulation pulses from any of the three internal stimulus generators. The three internal STG units send a trigger signals with each stimulation pulse on bits 4, 5 and 6 of the digital channel, Stimulus 1 on bit 4, Stimulus 2 on bit 5 and Stimulus 3 on bit 6. Please see chapter "Use of the Digital Channel in the MEA2100" for more details. So to trigger, for example on each pulse of Stimulus 1, a Trigger detector in MC_Rack must be set to the Digital Channel, bit 4. Please see screenshot below.

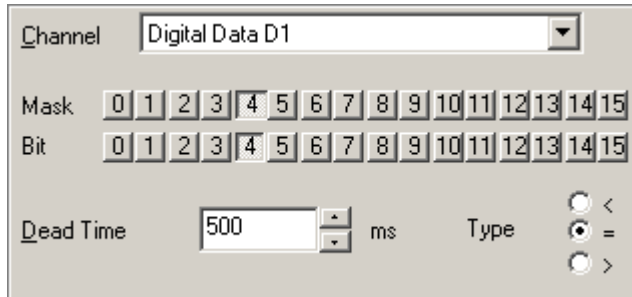

It is also possible to set the trigger detector to react on a signal from any of the three STG units. This might for example be useful to start a triggered recording if a stimulus is applied from any of the STG units. All three bits must be unmasked, and the bit value must be defined as > 0. See chapter "Triggering on TTL Pulses" for more information.

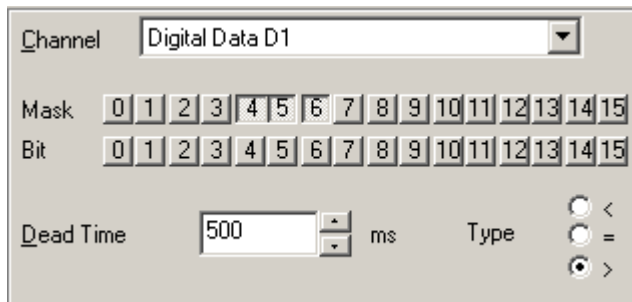

Triggered recording and any instrument which is below the Trigger Detector in the virtual tree of MC_Rack can now work in relation to the selected STG unit(s).

Real-time Feedback with MEA2100-System

Important: The Real-time Feedback function is not available for the MEA2100-32-System!

The interface board of the MEA2100-System is equipped with a high-capacity digital signal processor DSP. By moving the detection and analysis of signals from the data acquisition computer to the digital signal processor inside the interface, it is possible to run online filtering, analysis and feedback stimulation in real-time. Please read also chapter "Real-time Feedback".

At the moment, the real-time feedback is available for one instance of MC_Rack that means for one MEA2100-HS60, one MEA2100-HS120, or one MEA of a MEA2100-HS2x60.

By default, eight of the 16 bits of the digital channels are permanently assigned to the Real-time Feedback function. For each of these eight bits, a different condition can be defined to release a trigger signal. These eight bits can be monitored with the Digital Display. See also "Use of the Digital Channel in the MEA2100". The Real-time Feedback trigger signals are available in the "Trigger Detector", and can also be directly selected to start the internal stimulus generators. See also chapter "Starting and Stopping the Stimulation".

Setting up the Real-time Feedback Software

The "Real-time Feedback" works the same way as with the other data acquisition systems of Multi Channel Systems. The "Real-time Feedback" tool must be the first instrument under the data source. Click "Edit" menu and add "Real-time Feedback" or click the real-time feedback icon  in the toolbar. Please also read the chapter "Real-time Feedback" for details.

However, the dialog of the "Feedback Logic" tab is different for MEA2100-Systems. While the user can freely assign up to 16 different detection conditions to the 16 bits of the Digital Out channel in the other MEA- and ME-Systems, the MEA2100 offers by default up to eight conditions permanently assigned to eight bits of the Digital Channel. See also "Use of the Digital Channel in the MEA2100".

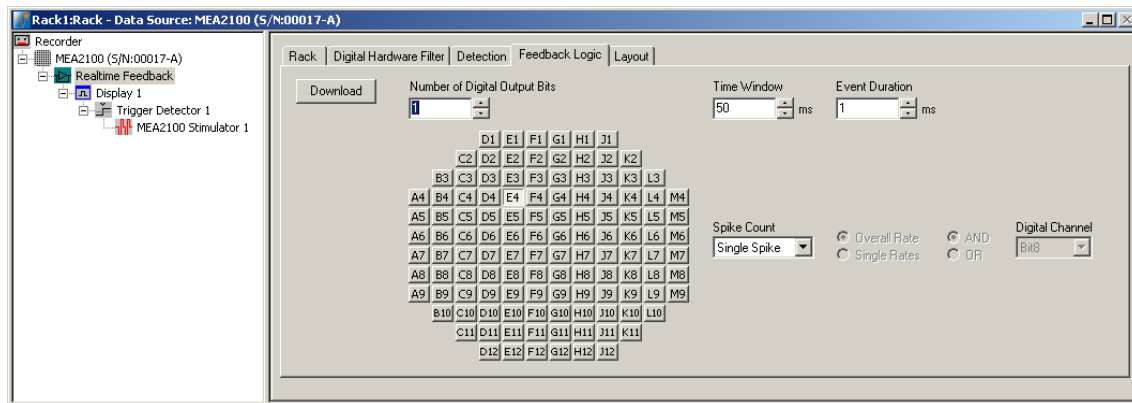

3.5 Wireless-System

3.5.1 Wireless System

When using a wireless *in vivo* recording system, the “Hardware” tab is modified. Please see also chapter “Defining a Data Source” and read the Wireless-System manual.

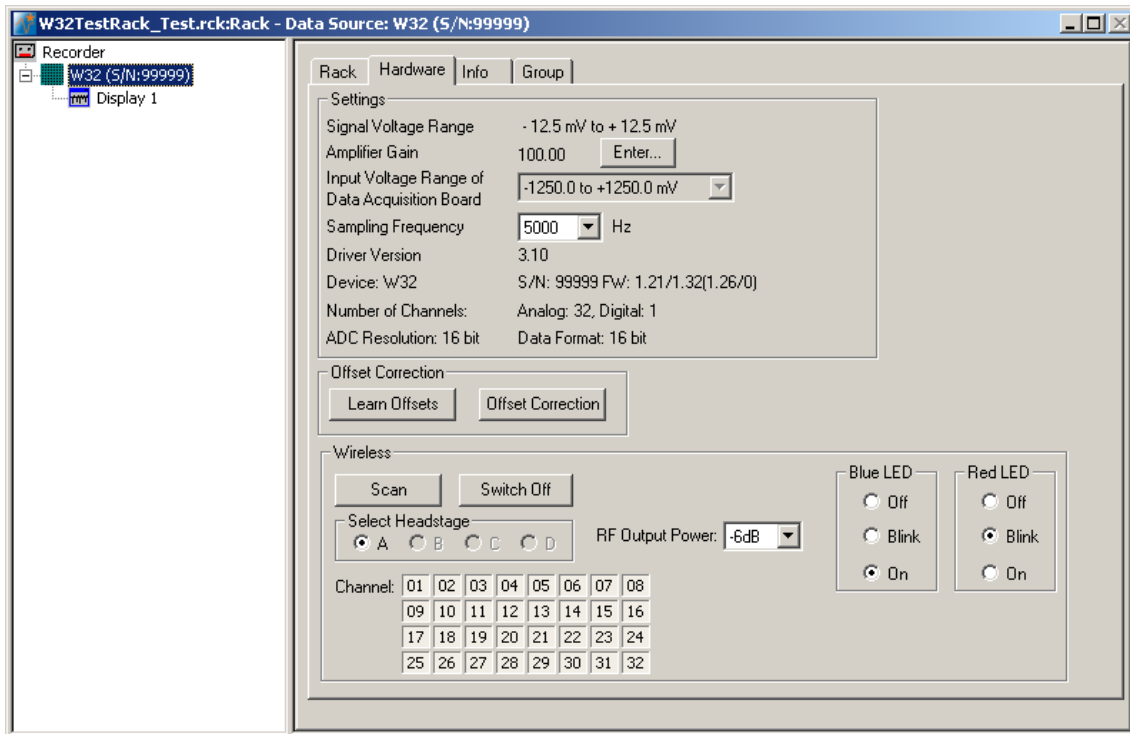

The additional option “Wireless” is for hardware and software control of the wireless *in vivo* recording system. One recording system can operate with up to four headstages simultaneously, but it is only possible to record from one headstage at a time. The headstages come preconfigured with different frequency bands by Multi Channel Systems MCS GmbH, and are labeled with A, B, C and D. The “Scan” function searches the complete frequency band and will detect all active headstages in range, and the radio buttons of the available headstages will become enabled in the “Select headstage” window. Now you can select one of the headstages for experimental processing only, the headstages do not work in parallel. In this example W8 headstages are connected and “A” is selected. Individual recording channels can be activated (pressed in) or deactivated. Inactivating channels can increase battery lifetime of the headstage.

Note: With all electrode channels, the maximum sampling rate for the 8-channel Wireless Recording System W8-System is 20 kHz. It is possible to increase the maximum sampling rate up to 40 kHz by deactivating at least four electrode channels. Please pay attention to the sampling rate respectively, when using the W4-, W16- or W32-System.

Note: Deactivated channels will vanish from displays and will be automatically deselected in analysis instruments (Analyzer, Spike Analyzer or the like). When reactivated, channels automatically reappear in displays, but must be manually reselected in the “Channels” tab of analysis instruments.

The button "Switch Off" can be used to send the currently selected headstage from "Stand By" mode to "Switched Off" mode, for saving battery energy. From this mode it is not possible to switch the headstage on again via software control.

The blue LED mounted on the headstage of the Wireless-System indicates the recording phases. It can be switched into three modes via radio button. Select "Off" if the laboratory animal is disturbed by the light. Switching off the LED will save a little bit of energy. Select "Blink" and the LED flashes during recording. Select "On" and the LED will be on permanently. This feature can be used, for example for camera tracking. The W32-headstage is equipped with two LEDs, a blue one and an additional red one which can be switched independently of each other. The user has the same options to set the red LED. Both LEDs together improve the camera tracking, because with two LEDs it is possible to track the orientation of the headstage.

Choose a "RF Output Power" value from the drop down menu. The smaller the value, for example -18 DB, the longer the storage battery will support the recording, but the smaller the distance between animal and receiver.

When operating a wireless *in vivo* system, there is an additional "WPA" status display for visualizing the current status of the connected headstage in the status bar at the bottom of the MC_Rack window.

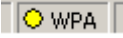

The WPA status display appears in green color when the W8-System is running. The color turns into yellow  three seconds after the data acquisition is stopped. The yellow color indicates a stand by mode: The headstage is in energy saving mode, but can be started again by pressing the MC_Rack "Start" button.

The WPA status turns red if the recording system does not have contact with the selected headstage. This can be the case if the "Switch off" button has been used to send the headstage into "Switched Off" mode, if the battery of the headstage is removed, or if the headstage is out of transmitting range.



The status will automatically become green or yellow again if a headstage comes back into range.

4 MC_Rack Features

4.1 About MC_Rack Features

This section provides more detailed information on all features of MC_Rack. The topics are in a systematic order.

4.2 Data Acquisition Settings

4.2.1 Data Source Setup

From the **Edit** menu, select **Data Source Setup** to configure the software according to your **MEA2100-System**, **USB based data acquisition** or **MC_Card** hardware. **Data Source Setup** is only available as long as your current virtual rack is empty (that is, only a **Recorder**, but *no data acquisition* or **Replayer** in the virtual rack). Configure the channel layout first and then set up the rack configuration, because it is not possible to change the data source setup or channel layout later.

The data source and channel layout configuration is saved together with the rack (*.rck) file, that is you can set up different racks for different hardware configurations. For example, the number of electrode channels may vary in different **ME-System** setups. As a **MEA-System** use, you only have to decide whether you have a MEA2100-System, a USB based data acquisition, or a MEA60-System (with a 64 channel MC_Card) or a MEA120-System (with a 128 channel MC_Card). The number of electrode channels is fixed and cannot be changed for a MEA-System, but it can be altered in USB based data acquisition systems.

You can also select **Simulation** as the data source. In **Simulation** mode, no data is acquired from the data acquisition, but simulated waveforms are played and can be used for trying out MC_Rack features. You can choose between sine waveforms on all channels, or the default simulation (different waveforms on a number of channels). If no data acquisition is installed (or if it is not properly installed), only Simulation is available as the data source.

MC_Rack Manual

If you use MC_Rack together with devices which do not require a MC_Card, but use an internal data acquisition and USB data transfer, the name of the connected device and its serial number will appear in the right Data Source drop down menu, for example, USB-ME16 or USB-ME256. On the left Data Source drop down menu is "USB MEA" displayed instead of MC_Card. Select the desired device as data source.

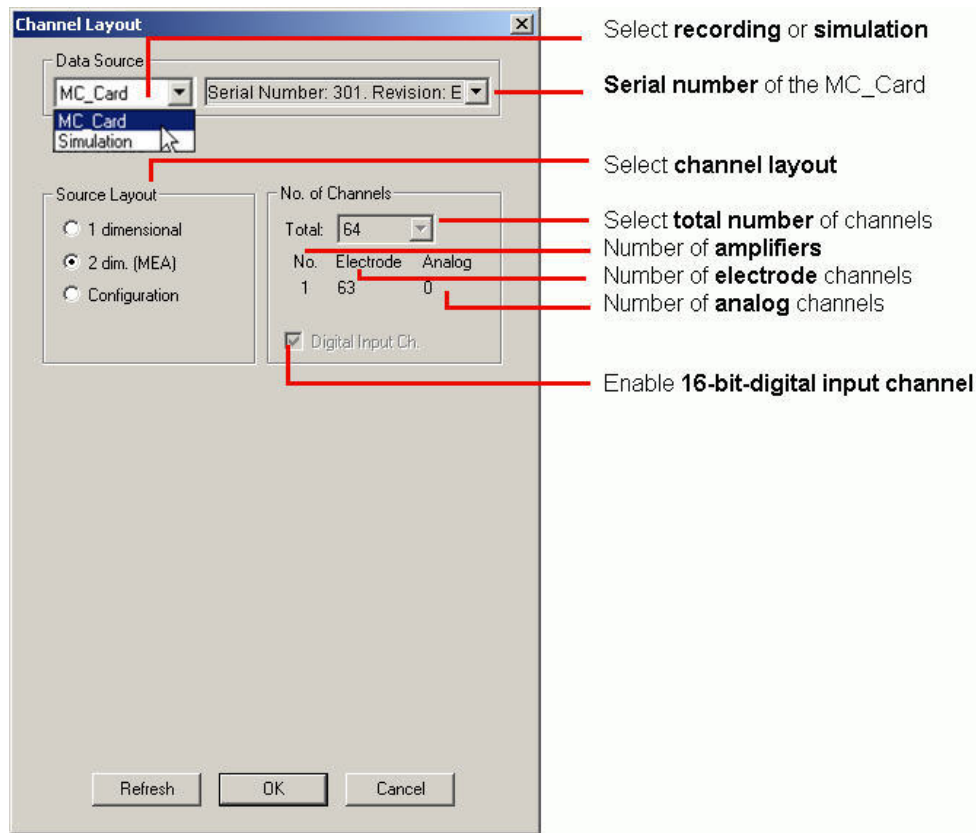

Note: If you open a rack with a different channel layout, the channel layout of the opened rack will be used. You can check the data source setup of the loaded rack by selecting the data source in the tree view pane of the virtual rack, and clicking the **Info** tab, as shown in the following screen shot.

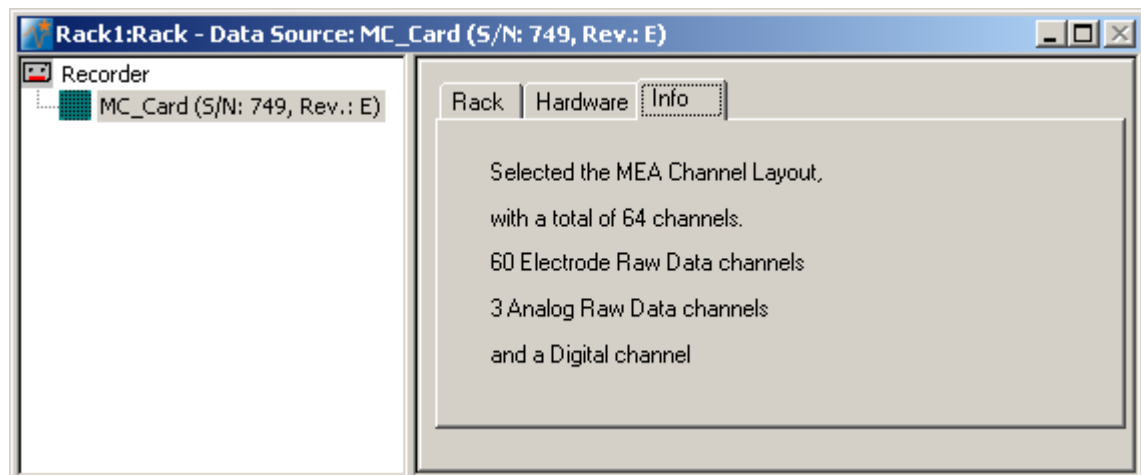

Important: Please note that the data source layout you choose (1-dimensional or 2-dimensional) does not only affect the numbering of the electrodes, but may also affect the compatibility with third party programs, for example, the MEA Tools. Make sure you always select the appropriate layout before setting up a virtual rack, and make always sure that the data source layout of the loaded rack file is appropriate before starting the data acquisition.

MEA60-System

Select **2 dimensional (MEA)** if you are using a microelectrode array (MEA) and a MEA60-System with 60 electrode channels, three analog channels, and a digital channel. The number and layout of channels is pre-configured and cannot be altered.

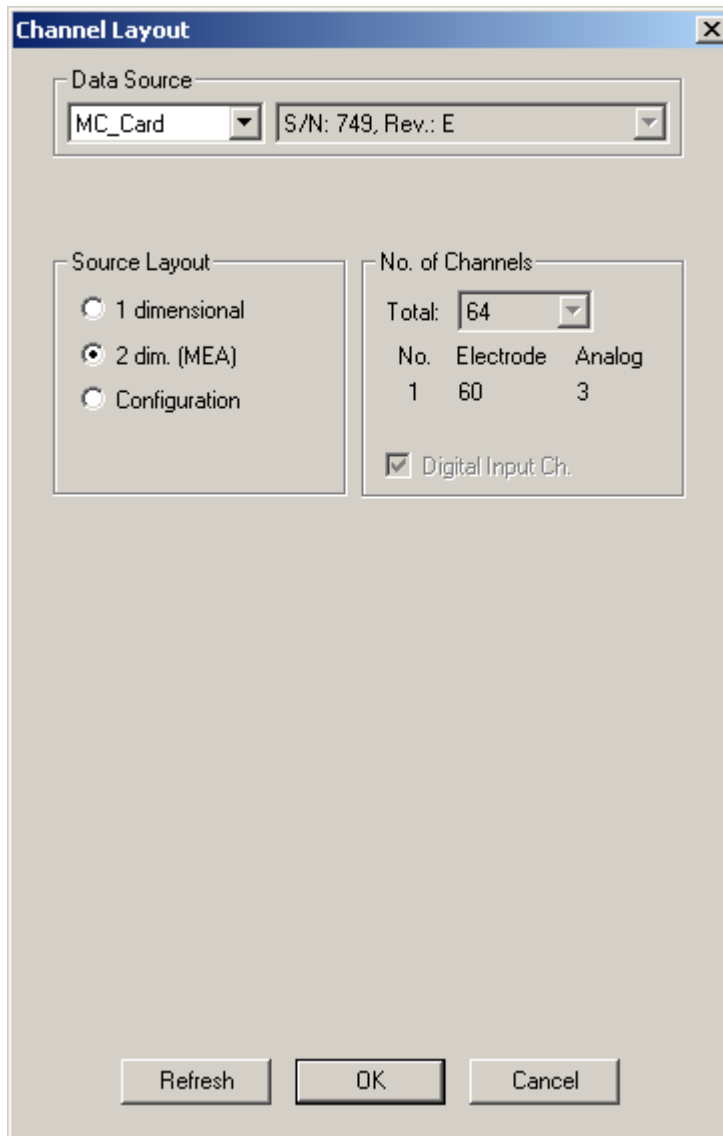

The image shows a software dialog box titled "Channel Layout". It contains the following elements:

- Data Source:** A dropdown menu set to "MC_Card" and a text field containing "S/N: 749, Rev.: E".
- Source Layout:** Three radio buttons: "1 dimensional", "2 dim. (MEA)" (which is selected), and "Configuration".
- No. of Channels:** A section containing:
 - A "Total:" label followed by a dropdown menu set to "64".
 - A table with three columns: "No.", "Electrode", and "Analog".

No.	Electrode	Analog
1	60	3
 - A checked checkbox labeled "Digital Input Ch."

At the bottom of the dialog are three buttons: "Refresh", "OK", and "Cancel".

MEA120-System

Select **2 dimensional (MEA)** if you are using two MEA1060 amplifiers and a MEA120-System with 120 electrode channels, 7 analog channels, and a digital channel. The number and layout of channels is pre-configured and cannot be altered. Only three of the analog channels (A1, A2, A3) are supported by the BNC connectors installed on the data acquisition computer.

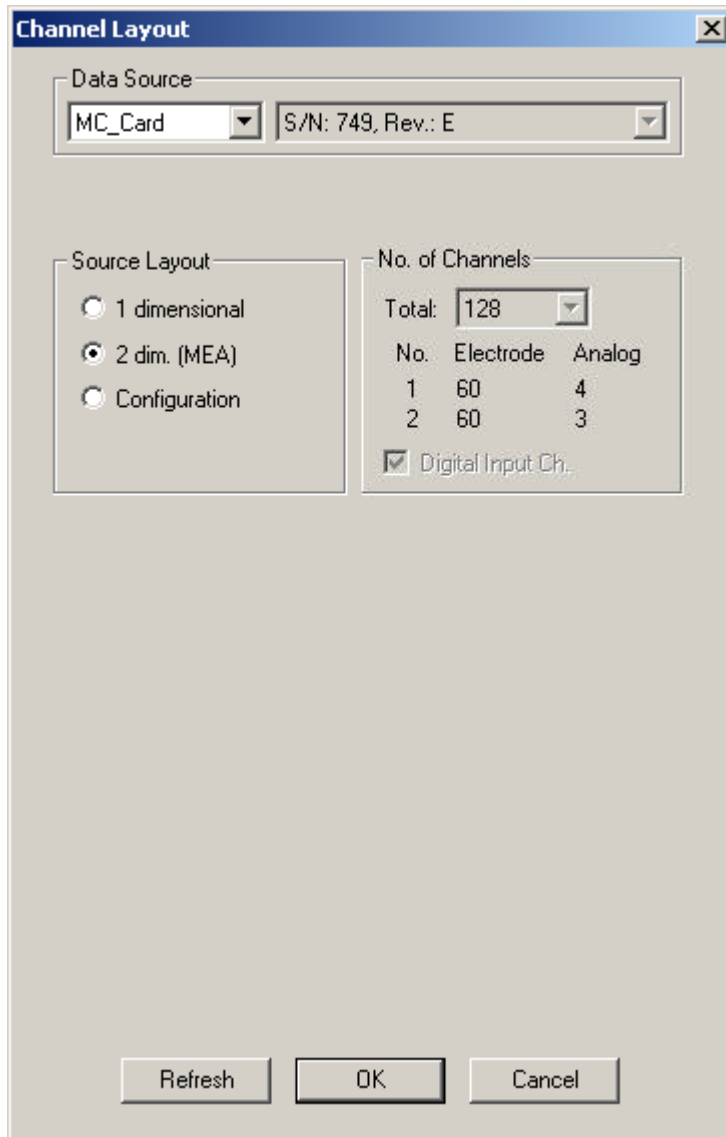

Linear (custom) Layouts / ME-Systems

Select **1 dimensional** if you are using any other type of data source, for example, a ME-System or a custom setup. Define the number of channels provided by your hardware, and specify how many electrodes (data amplified by the main amplifiers, for example, a MPA and a following filter amplifier) and how many analog inputs (for example, from a temperature controller or a microphone) are present. For the **electrode** channels, the original signal is calculated automatically according to the **gain** settings in MC_Rack. Signals on the analog channels are recorded "as is", with no respect to the gain.

Deselect the option **Digital Input Channel**, if you do not want to use the digital input channel. One of the digital input bits can be used for triggering the recording on a TTL output of the stimulator, for example. A typical configuration of an ME64-System would be 63 electrodes and a digital channel.

The screenshot shows a dialog box titled "Channel Layout" with the following settings:

- Data Source:** MC_Card (S/N: 749, Rev.: E)
- Source Layout:** 1 dimensional, 2 dim. (MEA), Configuration
- No. of Channels:**
 - Total: 32
 - No. Electrode: 31
 - Analog: 0
- Digital Input Ch.

Buttons at the bottom: Refresh, OK, Cancel

Data Source Configuration

Click "Configuration".

Configuration is an option that can also be used with MC_Card data acquisition (64 or 128 channels), but is recommended for the USB based data acquisition systems USB-ME64 / USB-ME/128 / USB-ME256. When selecting the configuration option, it is first necessary to adjust the number of channels available. After that you can select the amplifier(s) and MEA(s) in use from a drop down menu. To configure the MEA layout, please use the right drop down menu "MEA". To configure the amplifier, please use the left drop down menu "Amp" (MEA1060 without blanking circuit, gain factor 1200, and MEA1060BC with blanking circuit, gain factor 1100 for MEA-Systems, and FA64I/S, FA32I/S for ME-Systems).

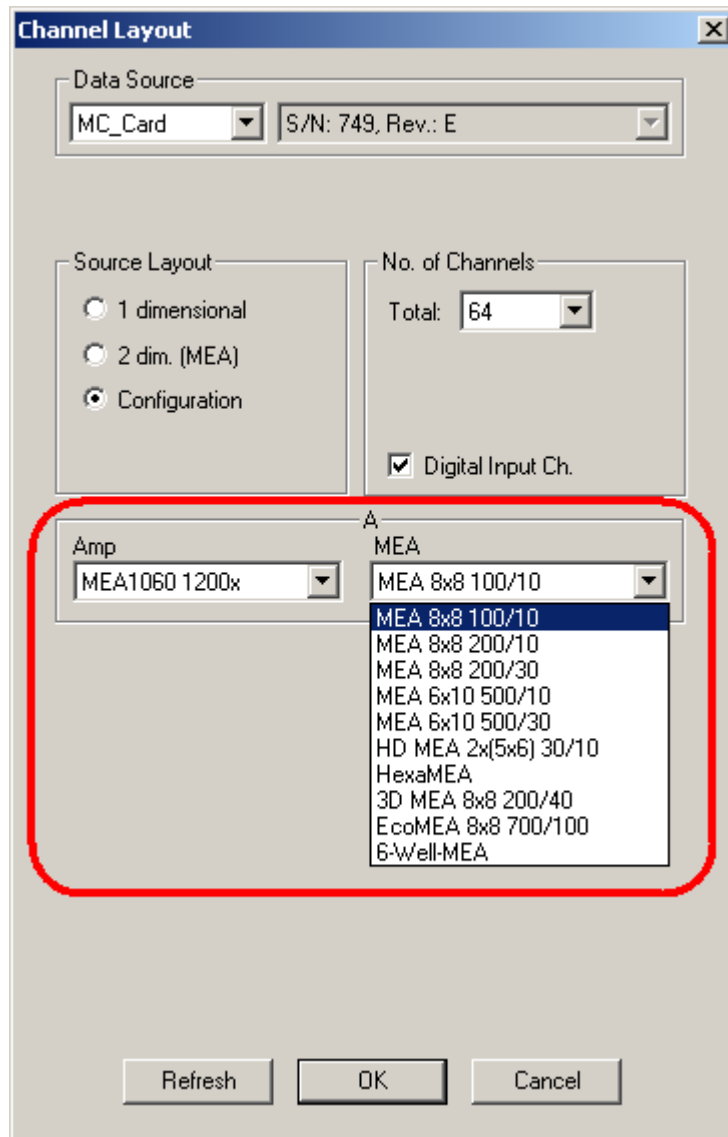

In MEA120-System it is possible to configure both amplifiers independent of each other. Additionally it is possible to configure the MEA layouts of both MEAs A and B individually.

Note: Setting up the configuration of the data source is important for having the correct layouts for MEA A and MEA B during the complete experiment.

Channel Layout

Data Source
MC_Card Serial Number: 301, Revision: E

Source Layout
 1 dimensional
 2 dim. (MEA)
 Configuration

No. of Channels
Total: 128
 Digital Input Ch.

A
Amp: MEA1060 1200x
MEA: MEA 8x8 100/10

B
Amp: MEA1060-BC 1100x
MEA: HexaMEA

MEA 8x8 100/10
MEA 8x8 200/10
MEA 8x8 200/30
MEA 6x10 500/10
MEA 6x10 500/30
HD MEA 2x(5x6) 30/10
HexaMEA
3D MEA 8x8 200/40
EcoMEA 8x8 700/100

Refresh OK Cancel

USB-ME16-FAI-System

The USB-ME16-FAI-System does not require a MC_Card, but uses an internal data acquisition. Data can be transferred via USB 2.0 port to any data acquisition computer. Please see USB-ME16-FAI manual for detailed information. Select **USB MEA** from the left Data Source drop down list. The USB MEA device will be specified on the right Data Source drop down menu: USB-ME16 (S/N: 00001). The number in brackets is the serial number of the device. The data source layout is 1 dimensional, with 16 electrode channels, and an additional digital channel.

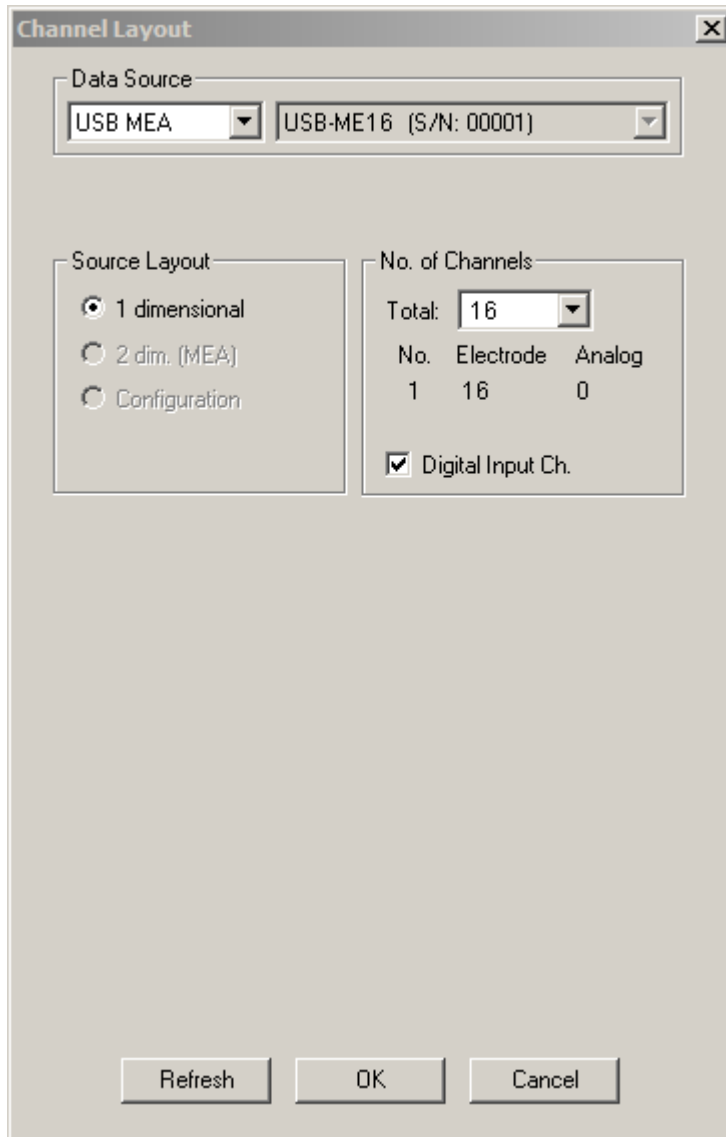

USB-ME32-FAI-System

The USB-ME32-FAI-System does not require a MC_Card, but uses an internal data acquisition. Data can be transferred via USB 2.0 port to any computer. Please see USB-ME32-FAI manual for detailed information. Select **USB MEA** from the left Data Source drop down list. The USB MEA device will be specified on the right Data Source drop down menu: USB-ME32 (S/N: 00001). The number in brackets is the serial number of the device. The data source layout is 1 dimensional, with 32 electrode channels, and an additional digital channel.

Channel Layout

Data Source

USB MEA USB-ME32 (S/N: 00001)

Source Layout

1 dimensional
 2 dim. (MEA)
 Configuration

No. of Channels

Total: 32

No.	Electrode	Analog
1	32	0

Digital Input Ch.

Refresh OK Cancel

USB-ME64 / USB-ME128 / USB-ME256 Data Acquisition

The USB-ME64 / 128 / 256 data acquisition systems are in principle the same devices, except for the total number of channels.

USB-ME256 Data Acquisition

The USB-ME256 is an external data acquisition device that uses USB 2.0 connection to transfer digitized data to any connected computer. Please see USB-ME64 / 128 / 256 manual for detailed information. Select **USB MEA** from the left Data Source drop down list. The USB MEA device will be specified on the right Data Source drop down menu: USB-ME256 (S/N: 00004). The number in brackets is the serial number of the device. Adjust the number of channels available.

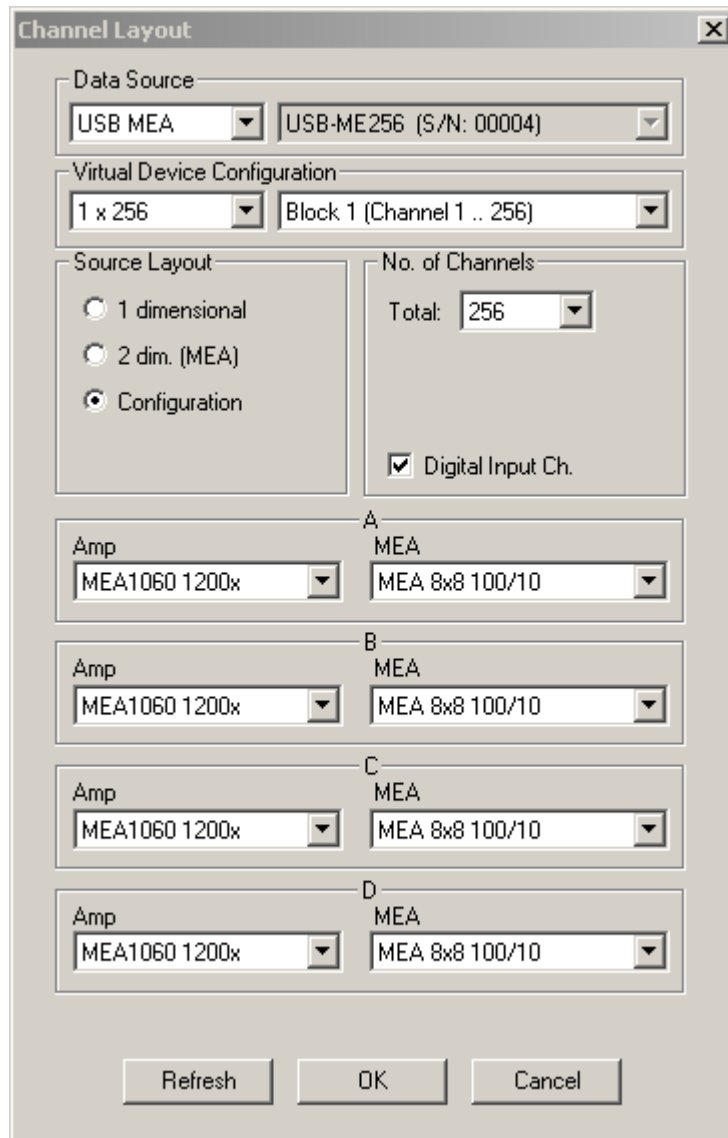

Click Configuration in Source Layout. Choose 256 as total number of channels from the drop down list under "No. of Channels".

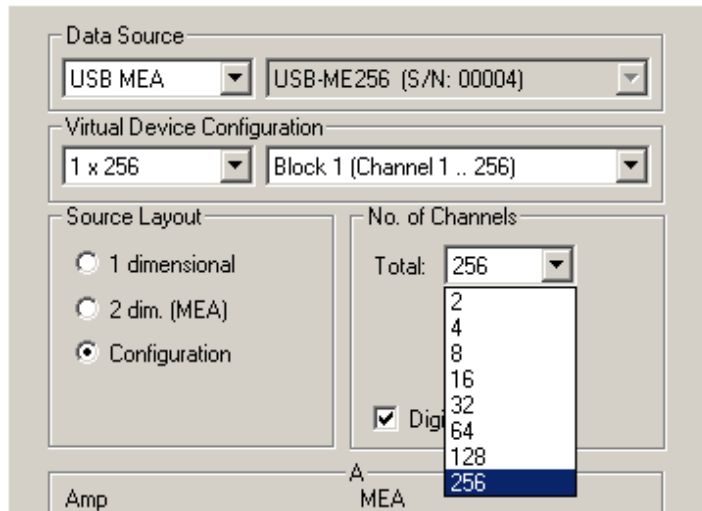

In USB-ME256-System it is possible to configure four MEA1060 / MEA1060BC amplifiers independent of each other. Click the amplifier drop down menus on the left side. Additionally it is possible to configure the MEA layouts for up to four MEAs A and B, C and D independent of each other. Click the MEA drop down menus on the right side.

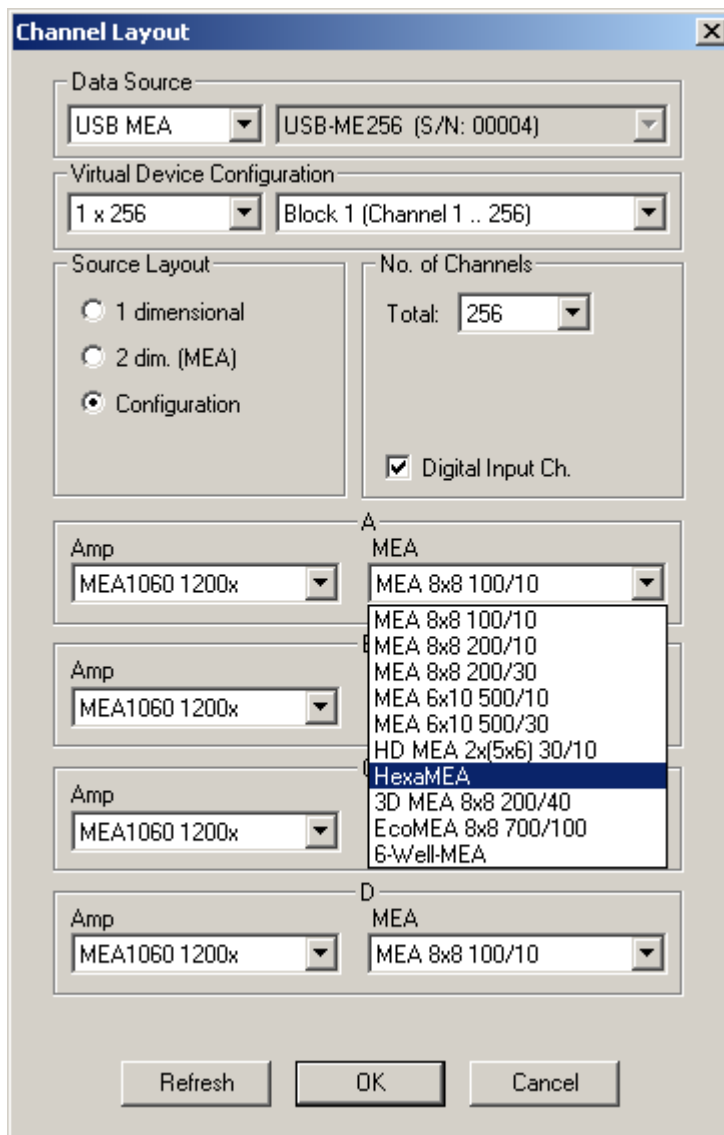

MC_Rack Manual

On the Edit menu, click Advanced Configuration to configure the software according to the USB-ME256 hardware. Please see Advanced Configuration for detailed information. The dialog **Advanced Configuration** is for optionally defining as many instances of MC_Rack software as necessary. That means, you are able to work with several MC_Rack versions in parallel, for example, when using the USB-ME256 with up to four MEA1060 amplifiers. With setting "Max. Number of MC_Rack Instances = 4" in Advanced Configuration you can control each of the four amplifiers independent from the others with its own MC_Rack software.

Note: Setting up the configuration of the data source is important for having the correct layouts for MEA A, B, C and D during the complete experiment.

USB-ME128 Data Acquisition

The USB-ME128 device is in principle the same device as the USB-ME256, except for the total number of channels that is 128.

The USB-ME128-System does not require a MC_Card, but uses an USB 2.0 port for the data transfer to the data acquisition computer. Please see USB-ME128 manual for detailed information. Select **USB MEA** from the Data Source drop down list. The USB MEA device will be specified on the right Data Source drop down menu: USB-ME128 (S/N: 0002), for example. The number in brackets is the serial number of the device.

In USB-ME128-System it is possible to configure two MEA1060 / MEA1060BC amplifiers independent of each other. Additionally it is possible to configure the MEA layouts for MEA A and MEA B independent of each other.

On the Edit menu, click Advanced Configuration to configure the software according to the USB-ME128 hardware. The dialog **Advanced Configuration** is for optionally defining as many instances of MC_Rack software as necessary. That means, you are able to work with several MC_Rack versions in parallel, for example, when using the USB-ME128 with two MEA1060 amplifiers. With setting "Max. Number of MC_Rack Instances = 2" in Advanced Configuration you can control each of the two amplifiers independent from the other with its own MC_Rack software.

Note: Setting up the configuration of the data source is important for having the correct layouts for MEA A and B during the complete experiment.

USB-ME64 Data Acquisition

The USB-ME64 device is in principle the same device as the USB-ME256, except for the total number of channels that is 64.

The USB-ME64-System does not require a MC_Card, but uses an USB 2.0 port for the data transfer to the data acquisition computer. Please see USB-ME64 manual for detailed information. Select **USB MEA** from the Data Source drop down list. The USB MEA device will be specified on the right Data Source drop down menu: USB-ME64 (S/N: 0002), for example. The number in brackets is the serial number of the device.

In USB-ME64-System it is possible to configure the MEA1060 / MEA1060BC amplifier. Additionally it is possible to configure the layout of MEA A.

Note: Setting up the configuration of the data source is important for having the correct layout for MEA A during the complete experiment.

USB-MEA256 Data Acquisition and Filter Amplification

The USB-MEA256 is an external data acquisition device with integrated filter amplifier that uses an USB 2.0 connection to transfer digitized data to any connected computer. Please see USB-MEA256 manual for detailed information. Select **USB MEA** from the left Data Source drop down list. The USB MEA device will be specified on the right Data Source drop down menu: USB-MEA256 (S/N: 00007). The number in brackets is the serial number of the device.

The screenshot shows a dialog box titled "Channel Layout" with a close button (X) in the top right corner. The dialog is divided into several sections:

- Data Source:** A horizontal container with two dropdown menus. The first dropdown is set to "USB MEA" and the second is set to "USB-MEA256 (S/N: 00007)".
- Source Layout:** A group box containing three radio buttons: "1 dimensional", "2 dim. (MEA)", and "Configuration". The "Configuration" option is selected.
- No. of Channels:** A group box containing a "Total:" label followed by a dropdown menu set to "256". Below this is a checked checkbox labeled "Digital Input Ch."
- Amp:** A group box with a dropdown menu set to "USB-MEA256-FAI".
- MEA:** A group box with a dropdown menu set to "256MEA 100/30".

At the bottom of the dialog, there are three buttons: "Refresh", "OK", and "Cancel".

Wireless Recording System

The wireless *in vivo* recording system is the all-in one solution for amplifying, recording, and analyzing *in vivo* data from eight channels that uses a wireless connection between headstage and receiver and an USB 2.0 connection to transfer digitized data to any connected computer. Please read the Wireless-System manual for detailed information. Select **USB MEA** from the left Data Source drop down list. The W8-System device for example, will be specified on the right Data Source drop down menu: MCS WPA8 (S/N: 00001). The number in brackets is the serial number of the system. The data source layout is 1 dimensional, with 8 electrode channels and an additional digital channel.

Note: With all electrode channels, the maximum sampling rate for the Wireless Recording System is 20 kHz. It is possible to increase the maximum sampling rate up to 40 kHz by deactivating at least four electrode channels. Please pay attention to the sampling rate respectively, when using the W4-, W16- or W32-System.

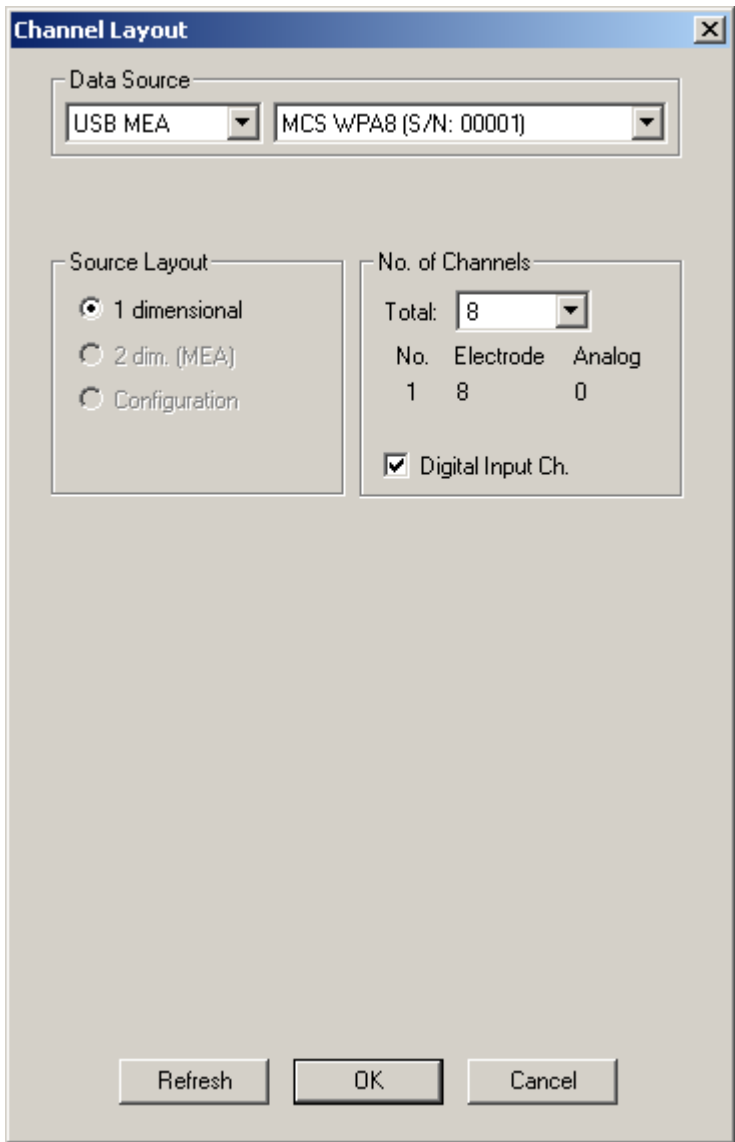

MEA2100-System

The MEA2100 recording system is an all-in one solution consisting of headstage and interface board. The MEA2100-System with integrated amplification, data acquisition, online signal processing, and integrated stimulus generator. You can connect one or two headstages to the interface board. The MEA2100-System uses an USB 2.0 connector per headstage to transfer digitized data to any computer. Please read the MEA2100-System manual for detailed information.

Select USB MEA from the left Data Source drop down list. The MEA2100 device will be specified on the right Data Source drop down menu: MEA2100 (S/N: 0000-A). The number in brackets is the serial number of the system, the character A labels the connected headstage, A is the first headstage, B is the second headstage. It is possible to run up to two instances of MC_Rack per headstage. Please read chapter "Advanced Configuration". Specify the "Number of Channels" first: 32 electrode channels, when connecting one headstage with 32 recording and 12 stimulation electrodes (MEA2100-HS32), 64 when connecting one headstage with 60 channels (MEA2100-HS60) or 128 electrode channels when connecting two headstages with 60 channels (MEA2100-HS60) or one headstage with 120 channels (MEA2100-HS2x60 or MEA2100-HS120) to the interface board. Choose "Configuration" in the data source layout. Enable the check box for the digital input channels. Select the correct headstage in the "Amplifier" drop down menu and specify the type of MEA.

The screenshot shows the 'Channel Layout' dialog box. The 'Data Source' section has a dropdown menu with 'USB MEA' selected and a text field containing 'MEA2100 (S/N: xxxxx-A)'. The 'Source Layout' section has three radio buttons: '1 dimensional', '2 dim. (MEA)', and 'Configuration' (which is selected). The 'No. of Channels' section has a 'Total' dropdown menu set to '64' and a checked checkbox for 'Digital Input Ch.'. The 'Amp' dropdown menu is set to 'MEA2100H-60' and the 'MEA' dropdown menu is set to 'MEA 8x8 100/10'. At the bottom of the dialog are three buttons: 'Refresh', 'OK', and 'Cancel'.

MC_Rack Manual

In MEA2100-System it is possible to configure two headstages independent of each other. MC_Rack identifies two connected headstages as completely different devices. They are defined via the character A or B in the serial number in the right "Data Source" drop down menu.

It is also possible to run two MC_Rack instances per headstage, for example for recording from the 2x60 channels of the MEA2100-HS2x60 headstage separately. Please read chapter "Advanced Configuration". Click the Amplifier drop down menus on the left side to configure the "Amplifier". Additionally it is possible to configure the MEA layouts for up to two MEAs A and B independent of each other. Click the MEA drop down menus on the right side.

MEA2100-32-System

The MEA2100-32-System is a descendant of the MEA2100-System with the same functions except of the real-time feedback. Please read the MEA2100 Manual for detailed information. Select **USB** from the left Data Source drop down list. The MEA2100-32 or MEA2100-2x32 device will be specified on the right Data Source drop down menu: MEA2100-32 (S/N: 00018-A). The number in brackets is the serial number of the device. The data source layout is Configuration, with 32 electrode channels, and an additional digital channel.

The screenshot shows the "Channel Layout" dialog box with the following settings:

- Data Source:** USB (left dropdown), MEA2100-32 (S/N: 00018-A) (right dropdown)
- Virtual Device Configuration:** 2 x 40 (left dropdown), Block 1 (Channel 1 .. 40) (right dropdown)
- Source Layout:** 1 dimensional, 2 dim. (MEA), Configuration
- No. of Channels:** Total: 32 (dropdown), Digital Input Ch.
- Amp:** MEA2100H-32 (dropdown)
- MEA:** pMEA-32S12-L1 (dropdown)

Buttons at the bottom: Refresh, OK, Cancel.

4.2.2 Defining Hardware Settings

Before you start building a rack, configure first the software according to your hardware and amplifier. The following example is for MC_Card and MEA1060 amplifier.

- Select the **MC_Card** from your rack and click the **Info** tab to see the channel layout information of your current rack. You cannot modify the settings anymore once you have added the **MC_Card** or the **Replayer** to your rack. If the settings are not appropriate, remove the MC_Card from your rack and change the channel configuration.

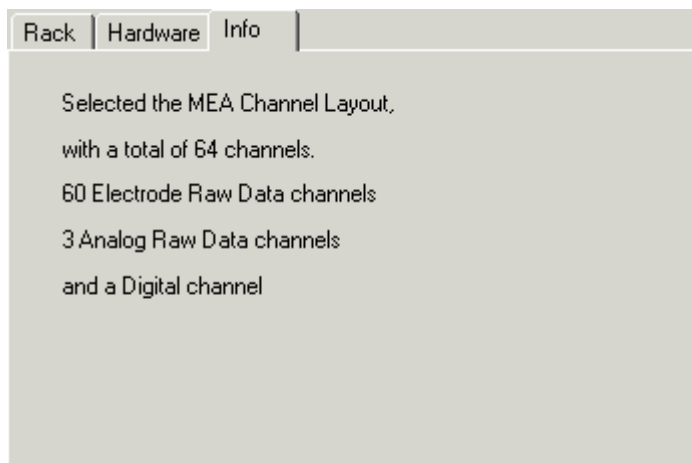

- Click the **Hardware** tab to define the other settings, like the amplifier gain and sampling frequency.

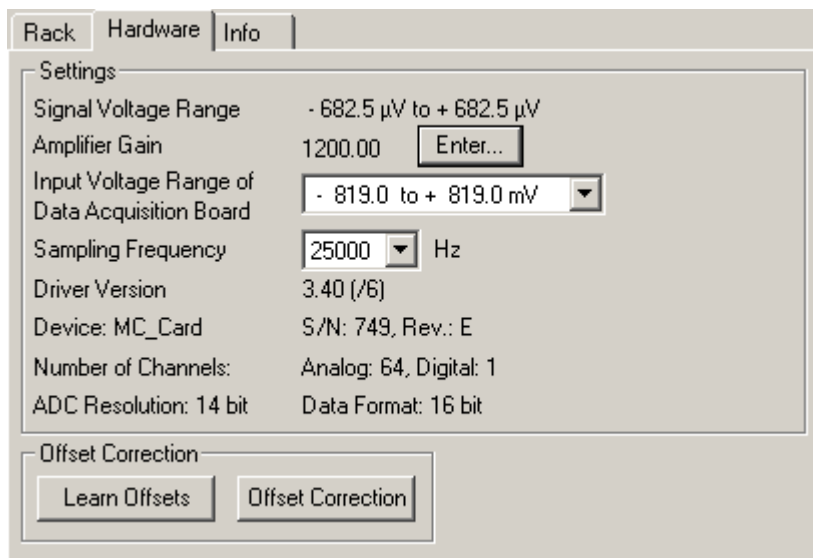

Signal voltage range

Please define first the "Amplifier Gain" and then the "Input Voltage Range of the Data Acquisition Board". The "Signal Voltage Range" is calculated by dividing the "Input Voltage Range of the Data Acquisition Board" and the amplifier gain factor.

Amplifier gain

Specify the gain of the amplifier used. The gain is an intrinsic option of the device and can not be altered. Make sure to use the gain the device actually has. Otherwise the recorded data will have wrong voltage values. The default amplifier gain of a MEA1060 amplifier is 1200. For MEA2100-Systems the amplifier gain is automatically set depending on the hardware. Any value between 1 and 1,000,000,000 is valid. The original signal is calculated automatically from the input and the amplifier gain.

Important: The gain is a hardware property. You cannot change the gain of the amplifier with MC_Rack. Make sure you use the gain that the amplifier actually has. This is especially important if you use a PGA amplifier with programmable gain. Use the PGA-Control program to change the PGA's gain and make sure you specify the same gain in the MC_Rack program as well. Otherwise, the recorded data will have wrong voltage values.

→ Click **Enter...** to change the amplifier gain settings.

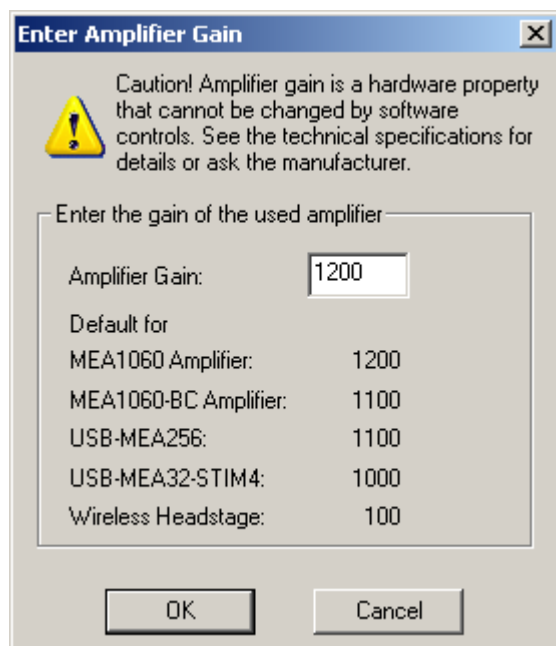

Input voltage range of data acquisition board

You can adjust the input voltage range of the MC_Card from +/- 400 mV to +/- 4 V with the software control in the MC_Rack program. The **lower** the input voltage **range**, the **higher** is the voltage **resolution**. You need a higher input voltage range if your biological sample generates higher voltages, for example, cardiac signals from whole-heart preparations, and / or if the amplifier gain is higher, so that the amplified output signal amplitude is higher, too. For spike data, an input range of -819 to +819 mV will in most cases be fine, whereas for sum field potentials like LTP that can be in the range of mV, you will probably need a higher input range.

For example, if you have a standard MEA amplifier with a gain of 1200, and choose a MC_Card input voltage range of 819 to +819 mV, this results in a **signal input range** of -682 to +682 μ V.

With a MC_Card with 14-bit resolution and an input voltage range of -819 to +819 mV, the voltage resolution of the MC_Card will be 0.1 mV or 100 μ V: A 14 bit resolution means $2^{14} = 16384$ available voltage values. $819 \text{ mV} * 2 = 1638 \text{ mV}$ total input voltage range / $16384 = 0.1 \text{ mV}$. For a standard MEA amplifier with a gain of 1200, this means a resolution of 83 nV for the recorded original signal.

→ Select the desired input voltage range from the **Input Voltage Range of Data Acquisition Board** list.

Sampling frequency

As a rule of thumb, the sampling rate should equal five times the highest signal frequency for a good digitized representation of the continuous analog signals. You would, for example, use a 5 kHz sampling rate when using a MEA1060 amplifier with a cutoff frequency of 1 kHz. It should be set according to the steepest slope of the expected signal. If the shape or amplitude of the signal is very important for your analysis, an even higher sampling rate might be appropriate. The maximum sampling rate is 50 kHz.

Please note that the sampling rate influences the amount of disk space needed and the computer performance. Do not use a higher sampling rate than necessary. If you have a low signal frequency (for example, from heart cells), you can use a much lower sampling rate than if you have high frequency signals (for example, from neurons). (For more information on recording and file size see "Recording Data").

If the sampling rate is too low, you will miss signals and / or see artifacts. The sampling rate should also be at least twice the bandwidth of the MEA1060 amplifier. Otherwise, aliasing occurs. See also the chapter "Filtering and Sampling Rate" for more information about aliasing.

Note: The sampling frequency should be at least **five times the highest signal frequency** and at least **twice the bandwidth of the MEA1060 amplifier**.

→ Select the desired sampling frequency from the **Sampling Frequency** list.

Maximal Sampling Frequency using the data acquisition devices USB-ME256 and USB-ME128

Usually, the maximal sampling frequency for MCS data acquisition systems is 50 kHz. However, when using some advanced features of the USB-ME256 and USB-ME128, some limitations apply.

The maximal sampling frequency that can be achieved with 256 channels is 40 kHz. This is possible when using the USB-ME256 with the "virtual device configuration" 1 x 256 (Please see Advanced Configuration). With the USB-ME256 and USB-ME128 it is also possible to split the data stream into 2 x 64 or 2 x 128 and into 4 x 64 channels, respectively, again by using the "virtual device configuration". These virtual machines can then be controlled independently by up to four instances of MC_Rack. However, splitting the data stream into several virtual devices consumes system performance. Therefore, the maximal sampling frequency is limited to 25 kHz when using the virtual device configuration 2 x 64 (USB-ME128) or 2 x 128 and 4 x 64 channels (USB-ME256).

Offset Correction

An offset correction is generally not necessary, because the intrinsic DC offsets of the MCS amplifier outputs and the MC_Card are very low in comparison to the signals of interest. You can use the offset correction feature to remove even this low offset and reset all channels to zero.

Note: If you observe a large offset on any channel(s), you should contact your local retailer for troubleshooting. The offset correction is not intended for removing large offsets, because the offset correction will decrease the input voltage range.

1. Click **Offset Correction** to activate the offset correction..
2. Click **Learn Offsets** to perform an individual offset correction for each input channel. MC_Rack takes **100 ms** of the recorded data in the moment when the button is pressed to calculate the DC offset. The mean of this 100 ms sweep is subtracted from the recorded data as long as the **Offset Correction** button is pressed. The individual offset values for each channel are saved in the local settings of the data acquisition computer and are only overwritten when you click **Learn Offsets** again. Make sure you press the **Learn Offsets** button **only** when you have no real input signals or irregular noise signals on the electrodes. To be on the safe side, you can connect a test model probe to the amplifier.

4.2.3 Channel Tool

The **Channel Tool** feature in MC_Rack allows the selection of one MEA electrode as reference electrode. The tool works similar to the offset correction and influences the signal to noise ratio. If there are problems with homogenous noise on all electrodes, the user is able to select one electrode without signal as reference. The voltage value of this reference electrode will be mathematically subtracted sample point per sample point from all electrode signals in the stream. For example, a low frequency noise on all electrodes will be eliminated this way.

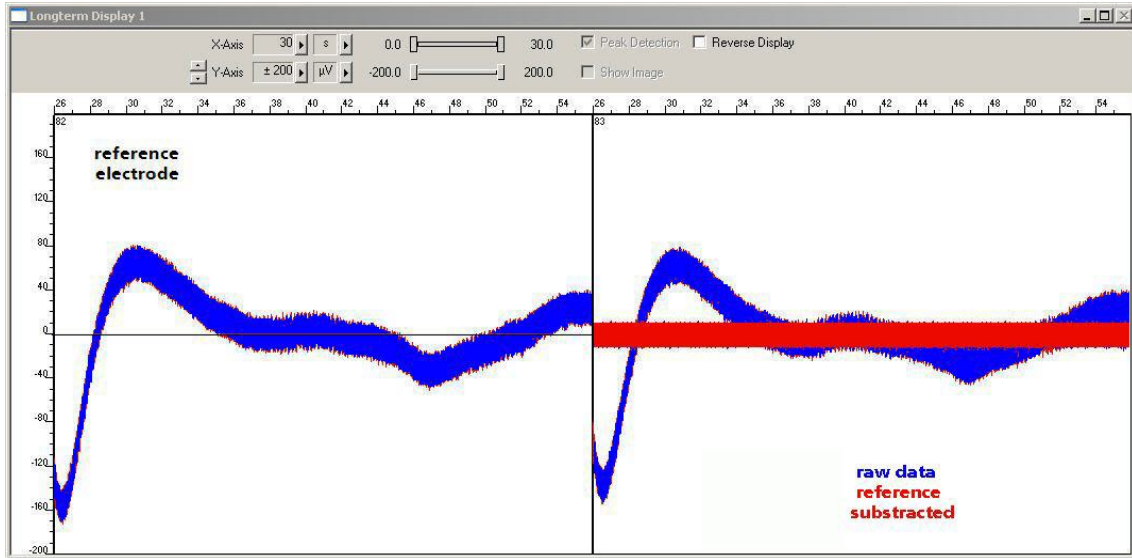

Note: Be careful to choose an electrode with noise only as reference electrode. If the reference electrode contains signals too, the value of the signals will be subtracted together with the noise value, and falsify the data.

Click the "**Channel Tool**" icon  in the main window toolbar, or select "Channel Tool" from the Edit menu. The following dialog appears. Click the "**Channels**" tab.

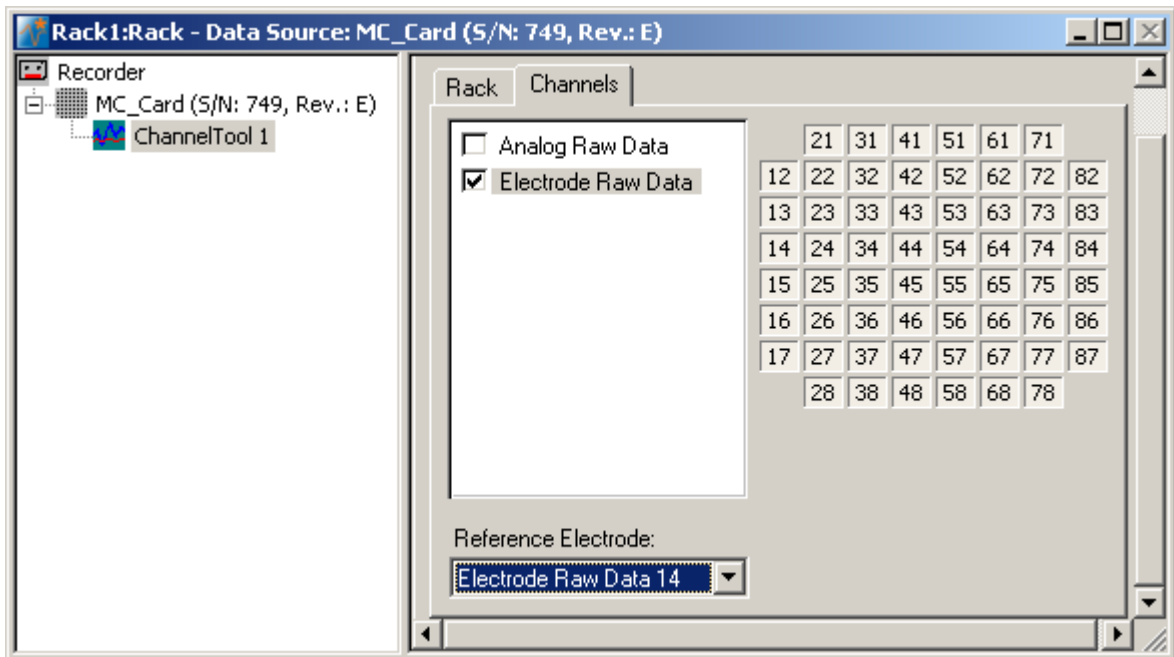

Select the data stream you want to apply the channel tool: Electrode Raw Data in this example. Select a "**Reference electrode**" from the "Reference electrode" drop down menu.

4.2.4 Grouping Multitrode Channels

Channels from electrodes with multiple channels (tetrodes or stereotrodes, for example) can be grouped. This feature will help to analyze signals from multitrodes with MC_Rack or with other analysis tools that can import MC_Rack files in the future. Right now, this feature is new and not supported yet. But we recommend to use the grouping anyway to take advantage of improved analysis features that will be made available in the future.

1. Add the **data acquisition** to your rack, and click the **Group** tabbed page to define the groups. This page is only available if you use a 1 dimensional channel layout (see Setting Up the Channel Layout).
2. Define the number of electrodes with multiple channels. On the right, the layout is updated accordingly. Each column represents a multitrode.
3. Define the number of channels per electrode. The number of rows is updated accordingly.
4. Assign the appropriate channel numbers to each channel.

You can load or set up predefined channel maps. See "Setting Up a Channel Map" for more details on the subject.

Grouping multitrode channels

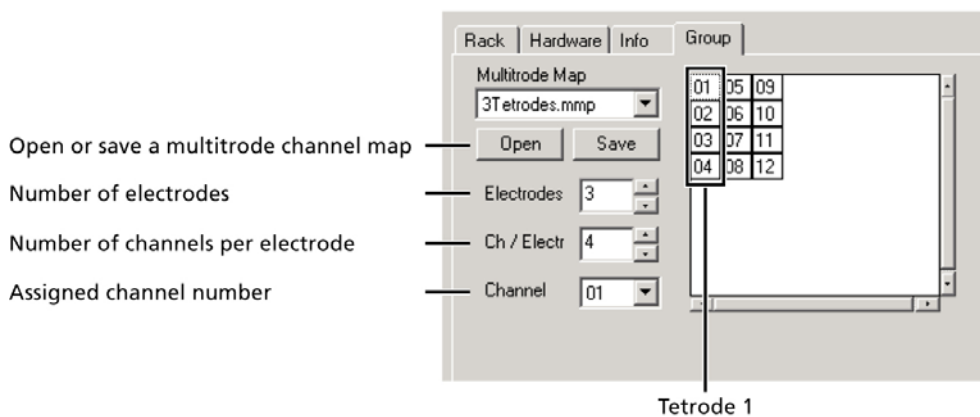

4.2.5 Simulation Mode

The simulation mode is available for users who are interested in learning more about the MC_Rack features, but do not have a data acquisition hardware available. Without properly installed hardware, MC_Rack starts in Simulation mode automatically. However, you can also switch from the default mode to the Simulation mode if you have installed a data acquisition device, for example, if you want to prove MC_Rack without connecting an amplifier.

In **Simulation mode**, no data is acquired from the data acquisition, but simulated waveforms are played and can be used for trying out MC_Rack features. You can choose between sine waveforms on all channels, or the default simulation (different waveforms on a number of channels). The third option is "File Source". Selecting this option an additional window pane appears and you are able to browse through your folders.

If no data acquisition is installed (or if it is not properly installed), only **Simulation** is available as the data source.



Warning: Make sure that you select the **data acquisition** as the data source (not the simulation) before starting an experiment. You cannot use a virtual rack that uses **Simulation** as the data source for experiments. With **Simulation** as the data source, no data will be acquired from the data acquisition.

1. From the **Edit** menu, select **Data Source Setup**. **Data Source Setup** is only available as long as your current virtual rack is empty (that is, only a **Recorder**, but **no data acquisition** or **Replayer** in the virtual rack).

2. Select Simulation from the Data Source list. Select either **Sine Waves**, **Default** or **File Source**.
3. Choose a data source **layout** and the number of **channels**. For more information, see "Data Source Setup".

The screenshot shows the "Channel Layout" dialog box with the following settings:

- Data Source:** Simulation (dropdown menu showing Default, Sine Waves, File Source)
- Source Layout:** Configuration (radio button selected)
- No. of Channels:** Total: 64 (dropdown menu)
- Digital Input Ch.:**
- Amp:** MEA1060 1200x (dropdown menu)
- MEA:** MEA 8x8 100/10 (dropdown menu)

Buttons at the bottom: Refresh, OK, Cancel.

With the option "**File Source**" in simulation mode you can open binary files with the extension ".raw" for simulating data. It is recommended to create these binary files with the software MC_DataTool, but you can use different software just as well, however the format of the file has to be binary.

Note: When creating a binary file with MC_DataTool, make sure to export as many channels to the binary file as should be simulated later.

Open a binary file in MC_Rack in simulation mode. Data of this file is repeated in a infinite loop.

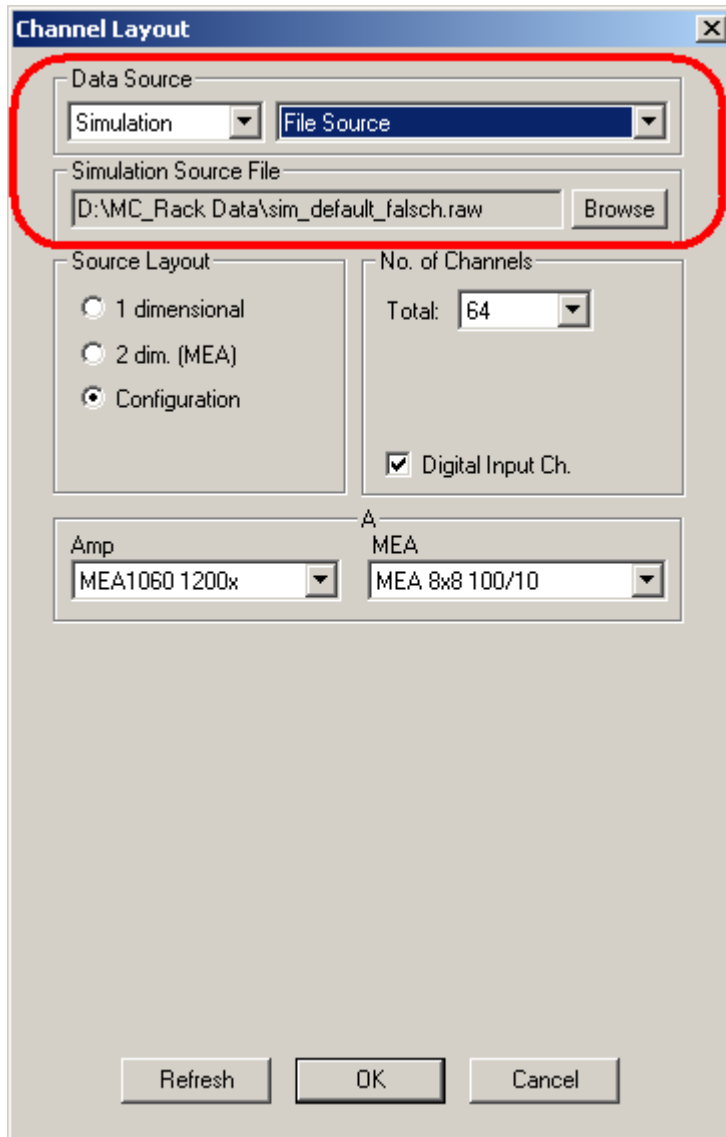

4.3 Data Streams and Channels

4.3.1 Data Stream Types

A **data stream** can include several channels of the same data **type**. The term **channel** means the data from a single data acquisition input pin, that is, one electrode.

Several different data streams can be generated, handled, processed, and recorded by MC_Rack. Data streams are either acquired by a MEA2100-System, an USB based data acquisition device or the MC_Card, for example, Electrode Raw Data, Analog Raw Data, and Digital Data, or they are generated by MC_Rack when processing input streams, for example, Trigger, Parameter, Spikes and Filtered Data.

You can adjust the number of analog and electrode channels according to your hardware in the **Channel Layout** dialog box, up to a total of 256 channels. One digital input stream with 16 channels (input bits) is available.

If you assign data to MC_Rack instruments, for example, the Recorder, you can select complete data stream(s), or you can pick individual channels of interest from a data stream.

In the following list, all data streams available in MC_Rack are briefly described. Some more complex data stream types are explained in more detail in the following chapters.

Definition of Data Stream Types

Electrode Raw Data: Unprocessed analog data acquired from an amplifier, for example, from a MEA2100 headstage, a MEA1060 amplifier for MEA electrodes or from a ME preamplifier like MPA8I or a wireless headstage. The amplifier gain can be specified in MC_Rack, so that the original signal is calculated automatically.

Analog Raw Data: Analog non-amplified data that is directly delivered to the data acquisition via BNC connectors, for example, channels A1, A2, A3 in the typical MEA layout. In MEA2100-Systems are eight, in USB-MEA- or USB-ME-Systems are four additional analog channels available. The data are delivered to the internal data acquisition, and send to the data acquisition computer via USB High Speed. You can use it to record additional information from external devices, for example, the heart rate, and so on. You can connect the Sync Out of a STG (stimulus generator) to an analog input to synchronize stimulus application and recording.

Digital Data: The 16 digital input channels of the data acquisition device can be used to record additional information from external devices as a 16-bit encoded number, or you can connect the Sync Out of a STG (stimulus generator) to a single input bit for synchronizing stimulation and recording. A digital IN/OUT connector is also available in MEA2100-, USB-MEA- and USB-ME-Systems. The 16 digital input channels are represented as the Digital Data stream that is, a stream of 16-bit values, each bit (0 to 15) representing one digital input. Standard TTL signals are accepted as input signals on the digital inputs. There are two possible logical states for each bit: 0 (low = 0 V) and 1 (high = 5 V). The digital input channels are sampled with the overall sampling rate selected in MC_Rack.

In the standard configuration, TTL signal sources can be connected to 3 BNC inputs (input bits 0, 1, 2). Alternatively, a 68-pin socket supporting all 16 input and output bits and a digital in / out extension with 16 BNC inputs and outputs can be ordered as accessories. Unused input bits, which have an undefined state, should be masked in the **Trigger Detector**.

For example, if the digital input bit 0 is set to high, the binary 16-bit value will be 0000000000000001, or 1 as a decimal number. If channel 2 is set to high, the value is (binary) 0000000000000010, or (decimal) 2, and so on. Any combination of logical states of input bits is represented by the 16-bit value.

For more details on the use of the Digital Data stream for triggering MC_Rack, please see the chapter Trigger Detector under MC_Rack Features. For more background information on digital data and binary code, please see the chapter

About Digital Data and Binary Code under MC_Rack Features, General Aspects.

- Trigger:** Generated by a virtual **Trigger Detector**. A trigger is used to control virtual instruments or to record triggered data. For example, you can use signals from an external device (for example, from the Sync Out of a STG) for triggering. For electrode raw data, parameters, or filtered data, you can define a threshold for triggering. You can define a bit pattern for using digital signals as a trigger. You can also program an automatic time-based trigger. The manual trigger allows the user to generate a trigger event manually during data acquisition.
- Filtered Data:** Generated by a virtual **Filter**. You can use several filters with different cutoff frequencies in your rack, for example, to remove background noise from your signals or to separate spike activity from local field potentials.
- Spikes:** Generated by a virtual **Spike Sorter**. Spikes can be detected by a threshold or by their shape. Spike data streams can be overlaid or displayed as a **Raster Plot**, sorted into up to three categories, or analyzed (the spike rate, for example).
- Parameter:** Generated by a virtual **Analyzer**. Several independent parameters can be extracted from the same or separate input streams, for example, the peak-to-peak amplitude, the spike rate, and so on.
- Averager:** Generated by a virtual **Averager**. You can average sweeps to enhance the signal to noise ratio. The averaged data can be saved and displayed. In addition to the averaged data stream, a trigger data stream is created (**Avg Trigger**). This trigger event is the time point of the last sweep. You need this trigger information to access the averaged data later. See also Averaged Data for more information.

4.3.2 Channel Selection

In the dialog box of the **Recorder**, **Filter**, **Spike Detector** and **Analyzer** tool, click the Channels tab to assign individual channels to the according virtual instrument.

You can conveniently select and deselect channels with the button array on the right side. You can choose single channels for recording, analyzing or displaying simply by clicking the appropriate buttons.

The button array is arranged either in the layout of the MEA or in a linear fashion depending on the currently selected stream and channel layout.

Selecting a data stream

The button array of the selected data stream is shown. The currently selected stream is highlighted in blue. If you want to switch to the button array of another stream, select that stream in the tree view to update the button array.

- Click the desired data stream listed on the left. A button for each channel of the selected data stream is shown.

Selecting a channel

The buttons represent single channels and have a toggle function. Click a button to select or deselect a channel.

- Click a button to select a channel. A selected channel button appears pressed in.
- Click a selected channel again to deselect it.

Selecting channels

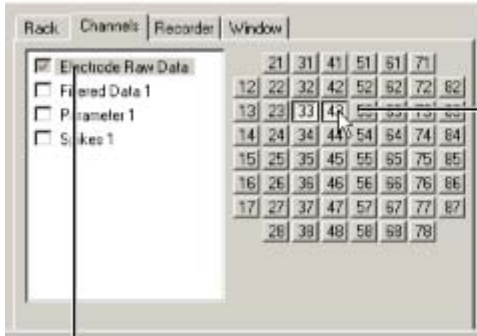

The channels of the selected data stream appear as toggle buttons in the designated channel layout. You can select single channels by clicking the corresponding buttons. Selected channels appear pressed in.

First, select the data stream by clicking the stream name.

If you want to select or deselect all channels of a stream, check the box next to the stream name in the tree view.

Selecting all channels of a data stream



Click the check box next to a stream name to select all channels.

Note: Click a data stream first to display the corresponding button array. Make sure you have selected the appropriate stream when selecting a channel.

4.3.3 Continuous and Triggered Data

You can create either continuous or triggered data files. **Continuous** data means that the data is recorded / processed by the virtual instruments as a continuous data stream without regard to a trigger event. Continuous data may still be synchronized to another system by starting the recording of the file on a trigger event. **Triggered** data means that only data sweeps around a specific trigger event are displayed, saved, analyzed, and so on. This has nothing to do with the data stream types included in the data file: All data streams can in principle be recorded either continuously or triggered, though it generally does not make much sense for all data stream types. For example, the recording of spike cutouts would be a typical application for a continuous recording (even though the spike data stream itself is not really continuous, it is treated as a continuous stream in MC_Rack), and the recording of evoked field potentials like LTP would be typical for a triggered recording (synchronized with the stimulation). Extracted parameters like the spike rate are a special kind of data stream, because these data streams include only single data points. Trigger settings in the **Recorder** do not apply to parameter streams.

A trigger event can be a **biological signal** crossing a threshold, or an **external** trigger event, like a TTL pulse. The trigger event is specified with the **Trigger Detector**.

The **Recorder**, the **Data Display**, the **Analyzer**, and the **Averager** can be triggered by a trigger event. You can define several triggers and assign them to separate virtual instruments. Use the **Window** tabbed page of a virtual instrument to assign a trigger to it (**Settings** to assign a trigger to the **Averager**, **ROI** for the **Analyzer**).

Note: MC_Rack stores the last two seconds of recorded data streams in a temporary virtual memory. Therefore, it is **not** possible to display streams with sweeps that are longer than **2 s** in MC_Rack. You can **record** longer sweeps and export the data to other analysis programs, though.

When using the **Replayer** for replaying triggered data, make sure all other virtual instruments in your rack are set up according to the data type. It is not possible to display triggered data streams continuously (as there are "gaps" between the sweeps where no data was recorded). The maximum x-axis range is limited by the sweep length. See the File Info of the Replayer to obtain all necessary information on the data file, such as the sweep length.

Assigning a trigger event to a virtual instrument

You can trigger a virtual instrument by any **Trigger** data stream. The trigger event is referred to as a time point of 0.

Triggering a virtual instrument

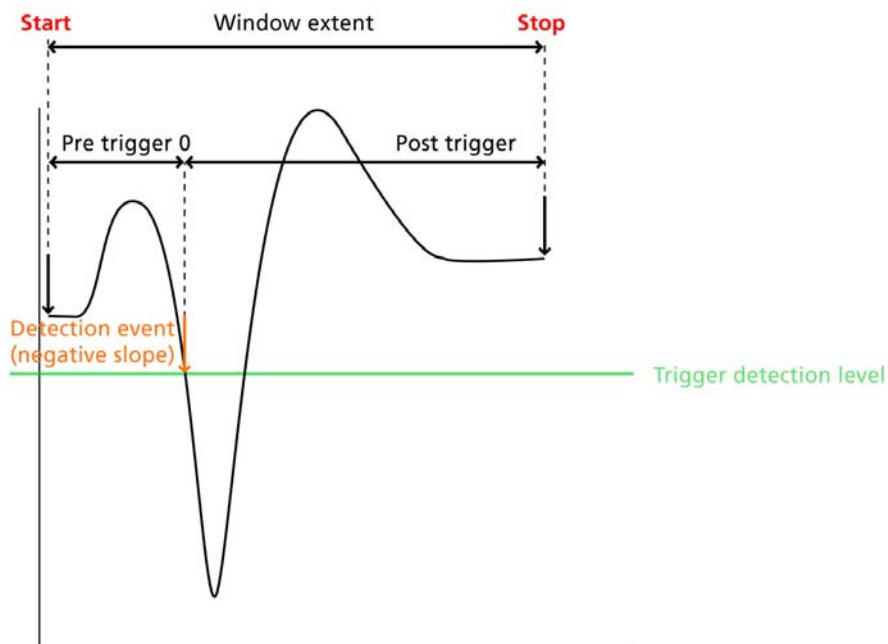

In the following example, the virtual instrument starts to process the data 30 ms before the trigger and stops after a total time of 200 ms (170 ms post-trigger time). This results in 200 ms sweeps. Please read chapter "Triggering MC_Rack on a stimulus" for more information about "Window Extent" settings.

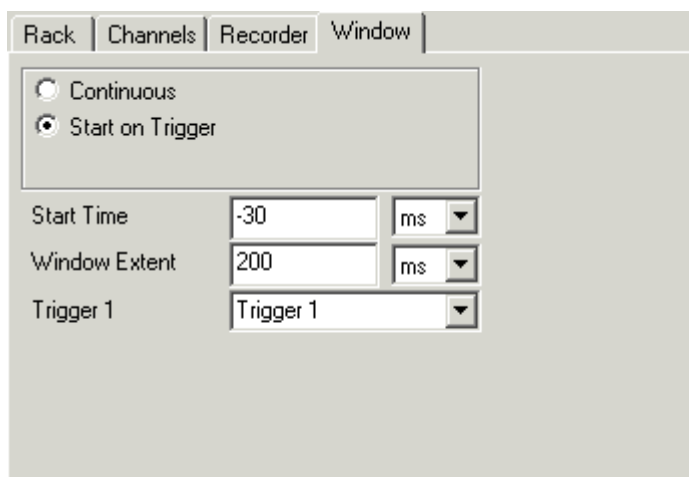

4.3.4 Averaged Data

Averaged Data, that is, a data stream generated by an **Averager**, is a special kind of triggered data. Only the last sweep of each averager cycle is added to this data stream. Therefore, a so-called **Avg Trigger** is saved together with the Averaged Data stream (not to be confused with the Averager Trigger that triggers the Averager). This Avg Trigger marks these last sweeps of a cycle. If you assign averaged data to another instrument, the Analyzer or a display, for example, you should use the Avg Trigger to trigger this instrument.

Recording averaged data

Together with the averaged data stream, the Avg Trigger is saved in the data file. You need this trigger when you assign the Averaged Data stream to another instrument, for example for triggering a **Data Display**.

Note: If you want to record averaged data and triggered data in the same data file, please make sure that the **Start Time** and **Window Extent** of the **Averager** and the **Recorder** match. Otherwise, you will not be able to review the **Averaged Data** stream later.

Replaying (or graphing) averaged data

In the following, it is described how to review an already save averaged data stream with the Replayer. For more information on how to generate an averaged data stream (either online during data acquisition or offline with the Replayer), please see chapter "Averager", "Averaging Data Sweeps".

For replaying recorded **Averaged Data** streams, click  to add a **Data Display** to the virtual rack. Do not use the Averager, which is only used for generating Averaged Data streams!

In the tree view pane of the virtual rack, select the **Data Display** (here: Display 1), and click the Data tabbed page. Select the **Averaged Data** stream (here: Averager 1). You can select the raw data stream as well, to overlay the averaged data with the raw data, for example.

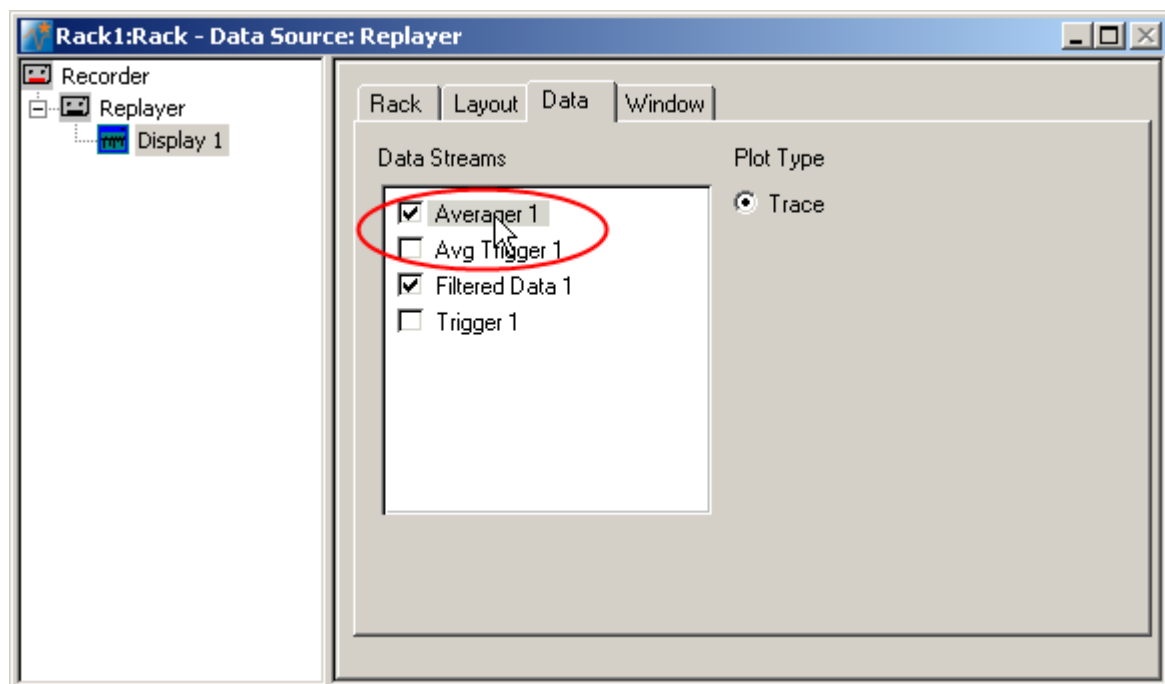

Click the Window tabbed page and select the option **Start on Trigger**. Select the **Avg Trigger** that was recorded together with the **Averaged Data** stream.

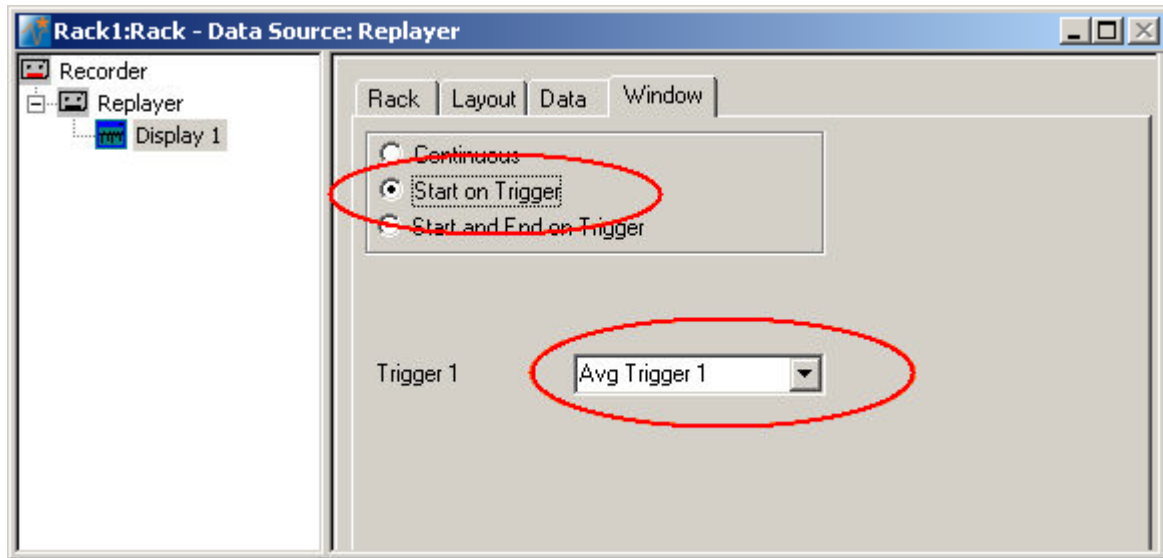

1. Click the **Start** button to start the **Replayer**. The averaged data sweep will appear at the time point when it was generated during the recording (here: after summing up 20 sweeps).

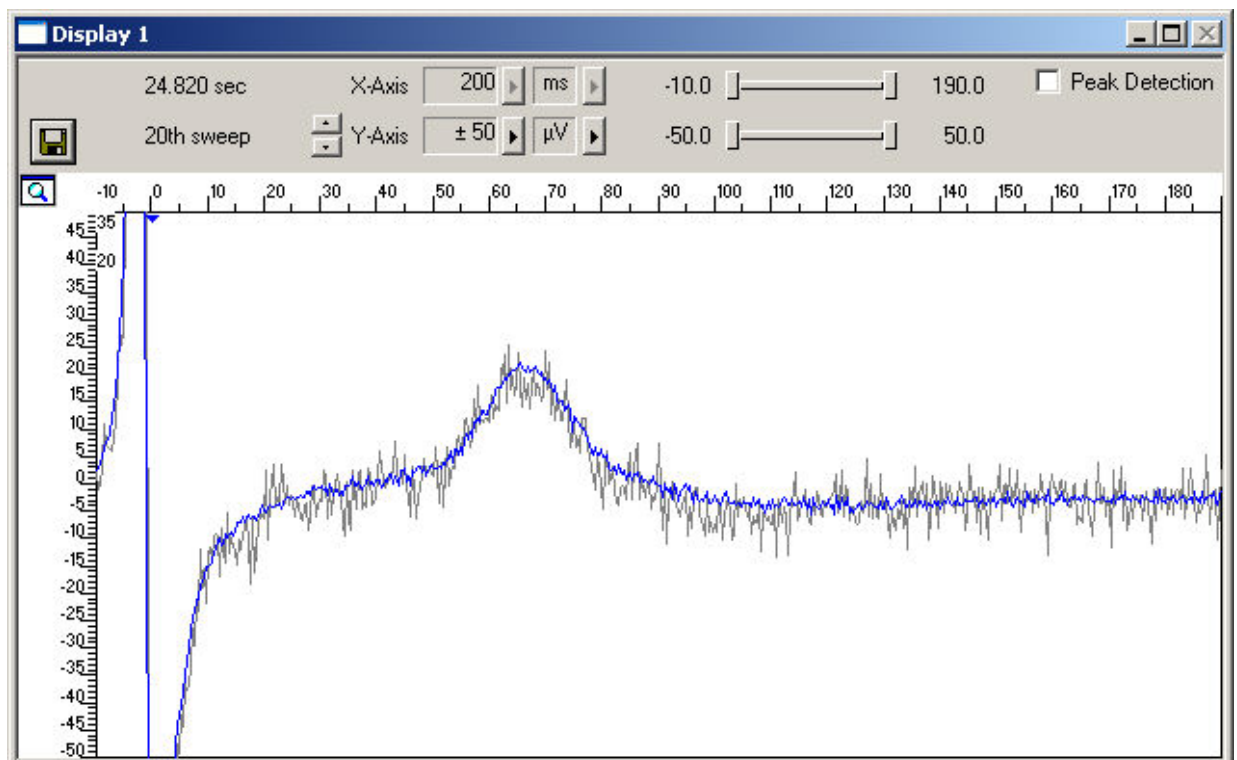

Overlay of averaged and raw data. The averaged data (in blue) was generated by summing up 20 x 200 ms sweeps (from 10 to 190 ms relative to the trigger event) and overlaid with the raw data (in grey).

4.3.5 Digital Data and Binary Code

Only two voltage levels are allowed as an input of the 16 digital channels: 0 Volts or 5 Volts. This means, that each channel can have either the state **high** (5 Volts), also called 1 or On, or **low** (0 Volts), also called 0 or Off. For example, if you use the Sync Out of a stimulus generator (STG) or another external device to trigger the recording, you can connect the device to one of the 16 digital channels. When the device is active, it sends a 5 V signal and the bit of the corresponding channel is high. This event can be used as a trigger (see Trigger Detector) for recording, or for triggering displays or analyzers.

For special advanced applications, it is also possible to encode more complex information from external devices in **binary code**. Because a single bit can only store two values, bits are combined together into large units in order to hold a greater range of values. Each bit combination encodes a **decimal** number. (Decimal numbers are the numbers we usually use in daily life.) The more bits you have, the more information you can encode. The number of possible values is 2 to the powers of N, where N is the number of bits.

If a bit is Low, its decimal weight value is 0. If it is High, the bit has a decimal weight value according to its position (see following table). The first bit has the number 0, and its decimal value is 1 if it is high. Each following bit doubles the decimal weight value of the preceding bit. This means, the decimal weight value of a bit is 2 to the powers of N, where N is the bit number. Mathematical convention sets out binary numbers with the lowest significant bit (the bit with the least value) on the right and with the highest significant bit (the bit with the greatest value) on the left (in analogy to the arabic decimal number system, which is also written from right to left). The total decimal value of all 16 bits results from adding up the single values.

Bit	15	14	13	12	11	10	9	8	7	6	5	4	3	2	1	0
Decimal value	2^{15}	2^{14}	2^{13}	2^{12}	2^{11}	2^{10}	2^9	2^8	2^7	2^6	2^5	2^4	2^3	2^2	2^1	2^0
	32768	16384	8192	4096	2048	1024	512	256	128	64	32	16	8	4	2	1

For example, if you had a 2-bit encoded number, the first bit would have a decimal weight value of 2, and the second bit of 1. This gives the possible decimal numbers shown in the following table.

Binary number	Decimal number
00	0 (0+0)
01	1 (0+1)
10	2 (2+0)
11	3 (2+1)

Accordingly, for 16 bits, there are 65,536 possible values, that is, 65,536 different states that can be defined. (Number 65,535 results if all 16 bits are High, 0 results if all bits are Low). For example, if the digital input bit 0 is set to high, the binary 16-bit value of the Digital Data stream in MC_Rack will be 0000000000000001, or 1 as a decimal number. If channel 2 is set to high, the value is (binary) 0000000000000010, or (decimal) 2, and so on. Any combination of logical states of input bits is represented by the 16-bit value.

Thus, you can use the digital data stream to retrieve and store encoded information from external devices for your experiment. This information can be displayed with the **Digital Display** either as a bit trace or as a decimal number. It can also be used to trigger events (see **Trigger Detector**).

4.4 Recorder

4.4.1 Recording Data

In MC_Rack, the rack you use to record and analyze data online and offline, and the data files are principally independent from each other. You can reuse a rack for several experiments and generate separate data files. You can then load the generated data file with another rack later for further offline analysis. The **Recorder** is used to record data acquired by a data acquisition device or data generated by an offline analysis to your hard disk. Every empty rack contains already a **Recorder**; you cannot add or remove a **Recorder** to or from your rack.

Data is saved as **binary data**, which is a very compact data type. A further compression (by zipping for example) can reduce the file size to half of its original size. The more redundant the data is, the higher is the compression that can be achieved. Arbitrary signals cannot be compressed further.

All channels that you assign to the **Recorder** are recorded to the same file. When you have an empty rack, the **Channels** tabbed page will be empty as well, because there are no channels available yet. As soon as you add a Data Source or a **Replayer** to your rack, the Channels page will be updated accordingly. You can assign all available channels you like from any data stream to the Recorder, but it is strongly recommended to choose the channels you like to record carefully, because the more channels you record, the bigger the file size will be. This is especially important if you use a high sampling frequency. For example, if you record 60 channels at a sampling frequency of 25 kHz, the data rate is 3 MB/s, that is 10.8 GB/h. Regard also the performance limit of your computer.

Selecting data streams and channels for recording

The fate of each single channel is independent from other channels. You can pick exactly the channels you like to save from all generated data streams. For example, you can decide to save only one channel of raw data, but the peak-to-peak amplitude results of all, or of a specific selection of channels.

Select the **Recorder** in the virtual rack tree view pane and then click the Channels tabbed page. On the white pane on the left of the Channels page, you see the data streams that are available with your data source settings, for example, the **Analog Raw Data**, **Digital Data**, and **Electrode Raw Data** streams for the MEA-System. It does not matter whether you have really connected a device to the inputs, though. If you have selected a channel layout without the digital input, the Digital Data stream will not be available, for example.

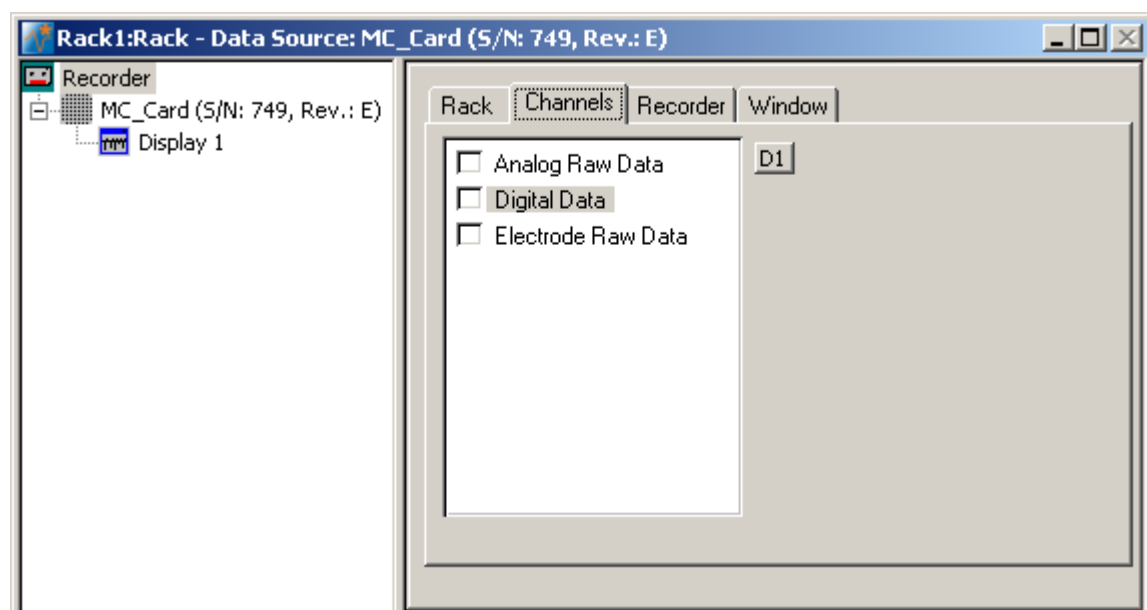

1. Click the data stream that you are interested in, that is generally the **Electrode Raw Data** stream. The available electrode channels appear in a button array on the right side.

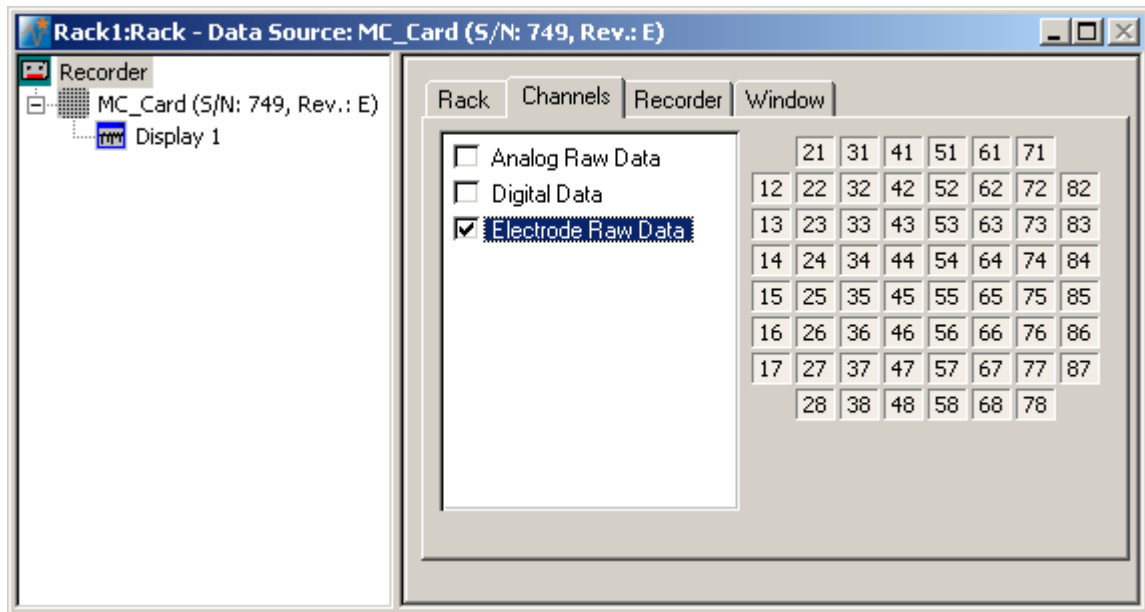

2. You can now either select all channels by clicking the check box next to the Electrode Raw Data stream name, or you can pick single channels by clicking the corresponding buttons. For more information, please see "Channel Selection" in the MC_Rack Features section. Only data from the selected channels will be saved to the hard disk.

Synchronizing the recording

For synchronizing MC_Rack to imaging or other recording systems, such as a patch clamp setup, there are basically two options. See also the chapter Continuous and Triggered Data for more information on the difference between continuous and triggered data files.

- A **triggered recording of sweeps** with a maximum duration of **2 s** (based on a **periodical trigger pulse**). This way, the generated data file stores only data cutouts around the trigger event (called triggered data). This is especially useful for analyzing evoked responses, for example, LTP experiments. For example, you can use the Sync Out pulse of a Stimulus Generator for triggering the sweeps. It is possible to record sweeps that are longer than 2 s, but please note that you will **not** be able to review or analyze the generated data file with MC_Rack, as MC_Rack supports only sweeps with a maximum duration of 2 s. You can still export the data from the file with MC_DataTool, though. See also "Recording triggered data".

Triggering the **start** and **stop** of the **recording** (based on a **single trigger pulse**): With the **Recorder** option **Create New File On Trigger**, a new file is created when a trigger event occurs. To start the recording, you still need to start MC_Rack with the **Start** button before the trigger event occurs. That means, the first data file will be unrelated to the trigger event, but you can delete this file if you do not need it. The second and all following files will be synchronized to the trigger. With this option, you can generate both **continuous** and **triggered** data files. You will need two different triggers (for example, one TTL pulse applied to digital input bit 0 and the other TTL pulse applied to the digital input bit 1) for triggering both the recording of **sweeps** with one trigger, and trigger the start of the recording (that is, the generation of the data file) with the other trigger. With the option **Stop on Trigger**, you can end the recording again (based on a second trigger).

Recording triggered data

When you record data that is triggered by an event, for example the response to a stimulation, please make sure that the **Recorder** is operated on this trigger, too (not continuously, to save disk space. Triggered data needs much less disk space than continuous data. Add a **Trigger Detector** to your rack and start the **Recorder** on the trigger event.

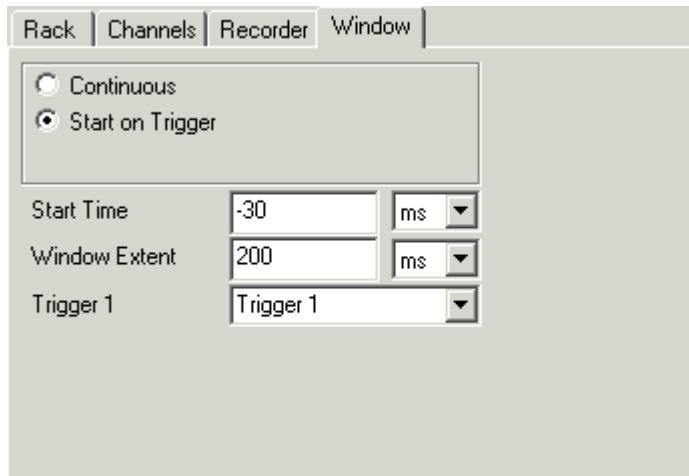

The window extent of the **Recorder** is the **minimum** dead time for the trigger, that is, no following trigger event will be accepted during the sweep. Please read chapter "Triggering MC_Rack on a stimulus" for more information about "Window Extent" settings.

Note: The **Recorder** does **not** allow **overlapping** sweeps, that is, trigger events that would lead to overlapping sweeps will be **ignored**. In other words, the **Analyzer** will only accept following trigger events after time point **T2 minus T1**.

Linking the background picture to the recorded data file

If you load a background picture into MC_Rack before starting the recording, the file name and path of the image file are automatically linked to the data file. That means, if you later load the data file, you will not have to load the picture again. If you save a **Replayer** rack with the loaded data file, the picture will be recalled automatically next time this rack is opened.

Please note that all file paths are absolute in MC_Rack, that is, do not move the picture file to another folder or directory in order to preserve the link.

If you load a picture file into a **Replayer** rack after recording the file without loading a picture first, the picture will not be linked to the data file.

4.4.2 Generating Data Files

Recorder Settings

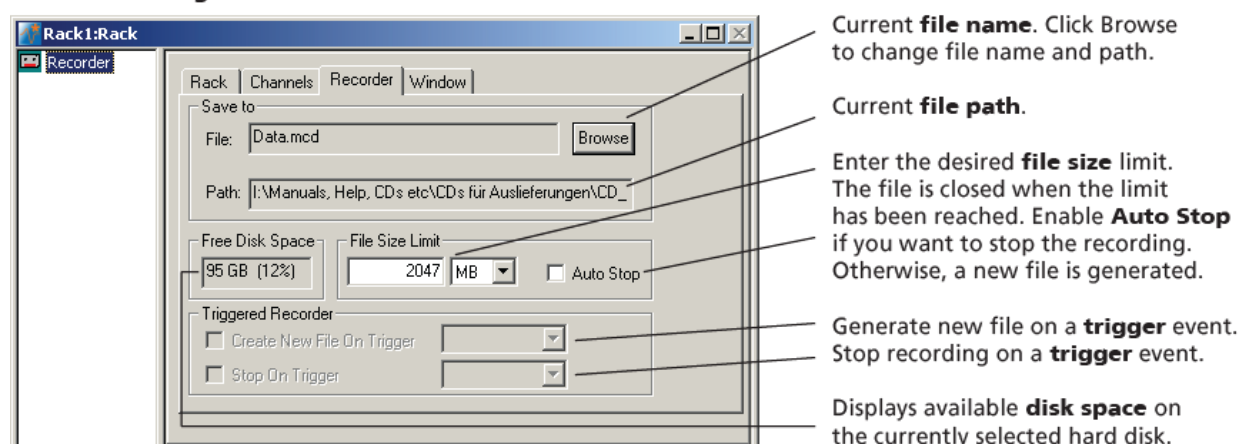

MC_Rack Manual

It is important to know that MC_Rack **never** modifies or overwrites any **existing** data file. That means, in an offline analysis (using the **Replayer**), the extracted parameter streams are stored in a **new** data file. Therefore, you need to specify a file name and path in the **Recorder** for both online and offline analysis.

Hint: If you want to store raw data and extracted parameters in the **same** data file, you can select the already existing raw data traces in a replayed file for **rerecording** them together with the extracted parameter streams.

File name and path

You can specify the file name and path of a MC_Rack data file with the extension "*.mcd". A file is never overwritten. If a file with the specified file name already exist, a new file with an extended file name is created. For example, if a file named example.mcd exists, files example0001.mcd, example0002.mcd, and so on, are generated automatically.

File size limit

- The file size is not limited by default, it may be as big as the maximum capacity of the NTFS files of the windows system is.
- You can limit the file size based on space used on the hard disk in MB or on time. If the option **Auto Stop** is not selected, new files are created if the file size limit is reached.

Select **Auto Stop** if you like to stop the recording after a certain period of time or when the specified file size has been reached. Only one file is created then.

- In any case, make sure you have enough disk space left for recording the data to avoid data loss.

Start and stop the recording on a trigger

Apart from the option of generating a triggered data file, that is, one or multiple data files containing sweeps based on a trigger event (which is generally useful for recording evoked responses), you can also start and stop the recording of continuous **or** triggered data files based on a trigger, for example, if you want to synchronize MC_Rack to an imaging or another recording system.

- The option **Create New File On Trigger** can be used to generate a new file on a trigger event. If the option **Create New File On Trigger** is selected, a new file is generated when the file size limit is met **or** when a trigger event occurs (whichever comes first). To start the recording, you still need to manually start MC_Rack with the **Start** button or menu command before the trigger pulse is applied. That means, you will generate a file before applying the first trigger pulse, but you can delete this file if you do not need it. The second file will then be synchronized by the trigger.

The option **Stop on Trigger** stops the data acquisition and recording as if the Stop button was pressed.

Note: Do not use the same trigger for recording and generating new files. Each sweep would then be saved in a new file, which does not make much sense and may lead to performance problems. Do not use the same trigger for recording or generating new files and for stopping the recording. A dead time of at least 500 ms is recommended for the trigger. If the dead time is lower and trigger events follow each other too fast, it may be possible that the software is not able to save the files fast enough. The data streams are internally handled in units of 100 ms. If two or more trigger events occur during one internal data unit, only the first is used for generating a new file, the following are ignored.



4.5 Replayer

4.5.1 Loading a Data File

Data files can be stored separate from the rack files. Use the **Replayer** to load a data file into your current rack. You can browse your folders and select an appropriate data file or select a file from the **Recent Files** list.

For replaying a data file, you need a virtual rack with a **Replayer** as the data source instead of the data acquisition device.

Setting up a rack for offline analysis

1. Create a new rack file by clicking **New** on the **File** menu.
2. Click  on the toolbar, or click **Add Replayer** on the **Edit** menu to add a **Replayer** to the virtual rack.
3. Load a data file into the **Replayer**.
4. Set up other virtual instruments like displays or analyzers for the offline analysis.
5. You can save the rack configuration for analyzing other data files with identical data streams and channels.
6. Click  on the toolbar or click **Start** on the **Measurement** menu to start the **Replayer** and the other instruments in the rack.

See also [Replaying Data](#) for more information on the **Replayer**.

Loading a Data File

Note: You can only load a data file that has the exactly the **same data streams and channels** as the data file that the rack was based on. For example, if you load a data file with exactly 60 Electrode Raw Data streams in the MEA layout and the Trigger 1 data stream into the Replayer, and then set up the rack for offline analysis, you can then later load only data files into this rack that also have (only) exactly 60 Electrode Raw Data streams in the MEA layout and the Trigger 1 data stream. If only one channel is different or missing, you will have to set up a separate rack file. Also, continuously recorded data will not be compatible with data recorded on a trigger, and vice versa.

1. In the tree view pane of the virtual rack, select the **Replayer**, and click the Replay File tab.
2. Click Browse to browse your folders and select a data file, or select a file from the recently used file list and click Open.

Loading a data file

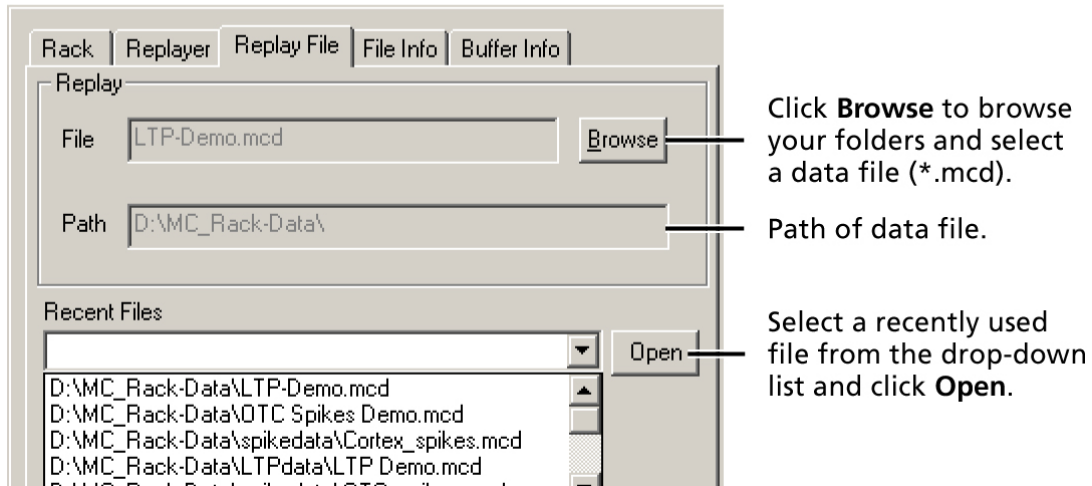

4.5.2 File Specifications

Some information about the experiment is saved together with the data. This information is displayed on the File Info page. It is very important to adjust other tools in the rack according to this information, especially if you have triggered data. See also "Triggered Data" for more information on this subject.

The following additional information is stored.

- Start and stop time (and date) of the recording
- Number of data streams
- Number of sweeps
- Pre-trigger event and window extent
- Sampling rate
- MC_Rack version that has been used to record the data file

The Buffer Info page shows all channels of the present data streams.

4.5.3 Replaying Data

The **Replayer** acts as a data source in MC_Rack, similar to the MC_Card or other data acquisition devices: Instead of recording data from the data acquisition board, it "generates" a data stream output by replaying a previously recorded data file. The data stream output of the **Replayer** can be assigned to the tools in your rack for reviewing data and / or offline analysis. The **Replayer** works similar to a tape deck or media player. You start to replay the loaded data file by clicking the Start button on the toolbar.

You can define the speed as well as pause and continue the replay. You can also define the start time, when the replay will begin. This is especially useful for long recordings that stretch across several hours. In addition to the automatic mode, you can also move through the file in single steps.

Hint: If you want to graph (already extracted) parameters, such as the spike rate, without a further offline analysis, replay only the parameter streams in the **Parameter** displays, with no further **Data Display** or other instrument. The replay speed will be much higher, and you will get the graphs much faster. Each virtual instrument in the rack will decrease the maximum **Replayer** speed.

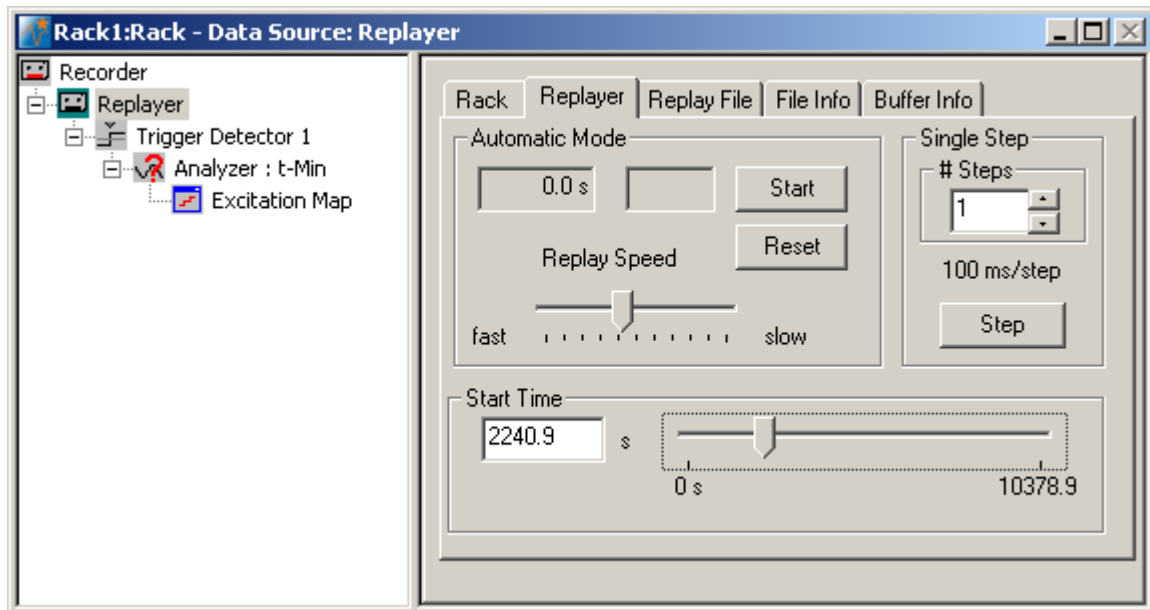

Browsing the data file and adjusting the speed

- Click  on the toolbar or click Start on the Measurement menu to start the **Replayer**.
- You can adjust the speed of the **Replayer** by moving the Replay Speed slider. If you move the slider to the outmost left (fast), the data file will be replayed as fast as possible (100 % CPU usage). The actual time point relative to the start of the recording, and the actual speed relative to the original signal input rate is displayed under **Automatic Mode**. For example, in the preceding screen shot, the current time point of the replayed data is 5.8 s after starting the recording, and the speed is 10 percent higher (1.1 x) than the original recording speed. The speed will change according to the CPU usage that the **Replayer** needs for the data, and according to background tasks. The faster the CPU, the faster will be the maximum speed.

Browsing the data file in single steps

This feature is useful if you look for a specific situation and want to go through your data thoroughly.

- Enter the **# Steps**, that is, the step size and click **Step** to replay the data stepwise. Make sure to set the step size equal to the refresh rate (continuous data) or to the window extent (triggered data) settings of your displays. Otherwise, you will not see a change each time you click **Step**, but only every second or third step, for example.
- You can click **Reset** to restart from the **Start Time**.

Changing the start time

If you did not change the start time, the Replayer will start to replay the data file from the beginning. If you are interested only in data that was recorded later, you can change the start time to begin the replaying of data at the specified start time.

- Enter the desired start time in seconds into the **Start Time** box.
- You can also use the slider to define the **start time**.

4.6 Displaying Data

4.6.1 Display Types

You can flexibly define the **electrode grid** for all displays. You can define not only the channels to be displayed, but also the position of the channels in the display. For example, you can arrange the electrode channels in the typical MEA layout, but you can also customize the layout freely according to your experimental setup.

All data streams that you have assigned to a display are shown on this display. There are different **display** types for different **data stream** types.

- The **Data Display** can show **Analog Raw Data**, **Electrode Raw Data**, **Trigger**, and **Spikes**.
- The Longterm Data Display can show **Analog Raw Data** and **Electrode Raw Data**,
- Only extracted **Parameter** streams can be assigned to the **Parameter Display**.
- The **Digital Display** displays **Digital Data** streams, that is, the TTL input signals on the digital 16-bit channel.
- There are also special displays for some virtual instruments: The **Spike Sorter** display, the **Analyzer** display (only in triggered mode), the **Averager** display. For these displays, the same general features are available as for the **Data Display**: The display settings, peak detection, background picture, and ASCII export.

Also, for each display, you can choose between different **plot types**, depending on the data stream type. The plot type defines **how** the data is shown on the display.

- When displaying **Raw Data**, only the **Trace** plot is available.
- **Spikes** can be shown in a **Trace**, **Overlay**, or **Raster** plot.
- **Parameters** can be displayed as a **Trace**, **False Color** or **False Color vs. Time** plot, or as a **Number**.
- The logical state of the 16 bits of the **Digital Data** stream can be displayed as a **trace**. The **decimal value** of the 16 bit encoded binary number can be displayed as a **number**.

The **ranges** of the x- and y-axis can be set only for the overall display. That means, if you have two data streams or channels that are based on a different scale (for example, not amplified Analog Raw Data and amplified Electrode Raw Data), it is recommended to use two separate displays and set the scaling accordingly.

4.6.2 Setting up a Display Layout

Similar to other virtual instruments, displays do not recognize active channels by themselves, but you have to set up a channel map for each display separately. A channel map defines the layout in which the channels of a display appear, that is, information about the channel numbers and their positions. There are several standard maps provided in the MC_Rack program folder, for example the standard rectangular 8x8 MEA grid. But you can set up and save your own custom maps as well. The advantage of this system is that you control which channels are displayed, thus saving computer performance. If you get a performance limit message, try to remove displays or to display fewer channels in the displays. Displays have a quite big impact on computer performance. Also, you can arrange the electrode channels in the display exactly as you like, thus trying to make the display look as similar as possible to the real electrode layout.

The channels of MEA A are tagged with an "A". Likewise, the channels of MEA B are tagged with a "B". If you have a MEA60-System (or an USB-ME64-System) in use, only channels of MEA A are available. If you have a MEA120-System (or an USB-ME128-System) in use, you can choose between MEA A and B. Channel maps for MEA A and B have been preconfigured, but of course you can set up any custom or "mixed" channel layouts as well. The USB-ME256-System provides up to four MEAs, the channels are tagged with A, B, C and D, and you can choose between MEA A to D.

Once you have loaded a channel map, this channel map is considered the default channel map for all following displays that you add later to your rack.

Note: You can set up any channel layout that meets your requirements and save it for later use. You can pick preconfigured channel maps for all MEAs available from Multi Channel Systems from the **MCS Channel Maps** drop down list. You can download channel maps for all MEAs available from **Ayanda Biosystems** from the Ayanda web site (<http://www.ayanda-biosys.com/download.html>).

Loading a preconfigured channel map

1. Choose the display that you like to modify and click the Data tab to select the appropriate data stream. The display is loaded in the default layout (that is, the last loaded channel map).
2. Click the Layout tab to modify the layout of the display.
3. Select **MCS Channel Maps** to select a default channel map available for various MEA types or linear layouts or select **User Channel Maps** to select one of your customized channel maps.
4. Select any channel map from the **Channel Map** drop-down list (available in the MCS default or in the user folder).
- OR -
Click Open and browse your folders to look for a specific channel map. Select a channel map (*.cmp file) of your choice and click Open. The display is updated accordingly.

Setting up a custom channel map

1. Choose the display that you like to modify and click the **Data** tab. The display is loaded in the default layout (that is, the last loaded channel map).
2. Click the **Layout** tab to modify the layout. In the **Rows** and **Columns** boxes, you can now modify the layout.
3. Type or select the total number of **Rows** and the total number of **Columns**. In the preview on the right, the layout is updated accordingly.
4. Assign the appropriate channel number to each slot. Click a slot in the preview to make it active. The active slot is highlighted by a tiny dotted line. Click the desired channel on the **Channel** list or type the appropriate channel number. The display is updated accordingly.
5. If you like to keep this layout for future use, click Save. The **Save Channel Map File** dialog box opens.
6. Browse your folders and enter a file name.
7. Confirm by clicking Save. The channel map is saved as a *.cmp file. You can now load this map into other displays.

4.6.3 Display Settings

Display settings

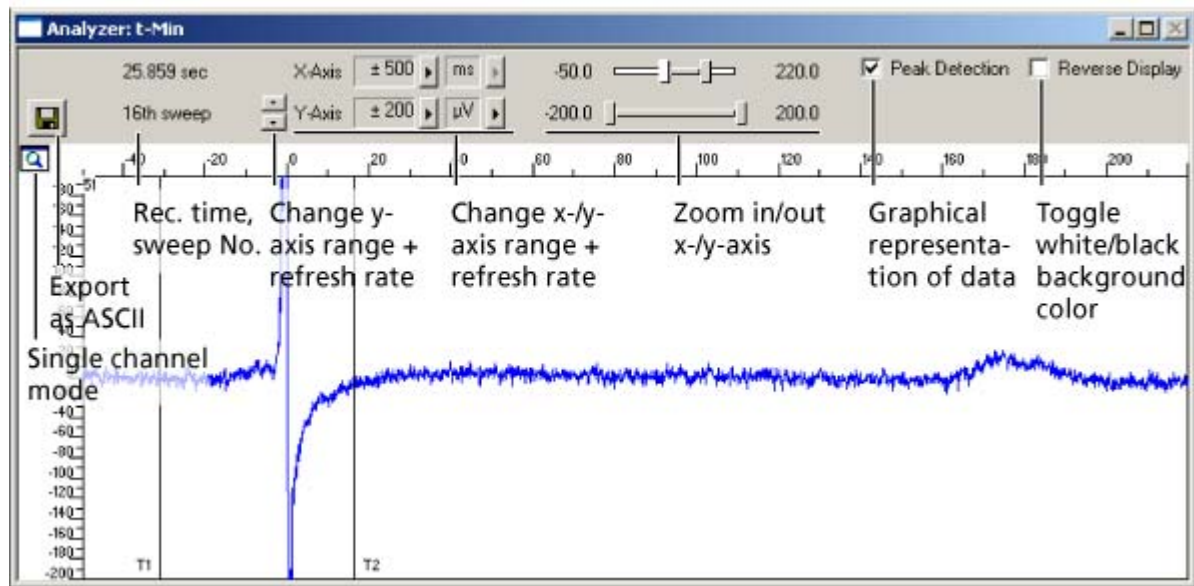

You can select the range and refresh rate of the display from the drop-down lists. In addition, you can zoom the display by moving the sliders.

MC_Rack stores the last **two seconds** of recorded data streams in a temporary virtual memory. Therefore, it is not possible to set the time scale wider than 2 s.

If you run the display in triggered mode, the sweeps start with the trigger event = time point 0. You can set the time scale to negative values to display pre-trigger times (if you display continuously recorded data or if the triggered data was recorded with a negative = pretrigger start time).

Zooming a channel

All available channels are shown in the display to provide an overall view of the ongoing activity.

- Simply double-click a channel to have a closer look at it. The magnifying-glass icon in the top left corner indicates that you are in zoom mode. The channel number is displayed in the top left corner next to the axes intersection point.
- Double-click the zoomed channel again to restore the overall view.

Changing the ranges and refresh rate

Select the appropriate range from a set of fixed values in the **X-Axis** or **Y-Axis** drop-down lists. If you change the x-axis range, you will also change the refresh rate and the sweep size. You cannot change the x-axis range for replaying data that was recorded on a trigger, as the recorded cutouts have a fixed length.

- You can also move through the set of fixed values in the **Y-Axis** list by clicking the up and down arrow buttons.

Zooming a part of the sweep

Note that if you zoom continuous data with the sliders, you will not see the complete recorded data traces anymore, but only the zoomed section. (In contrast, if you display continuously recorded data and change the x-axis range in the drop-down list, you will still see the complete data traces, but in smaller or larger sweeps. If you display triggered data or display continuous data in a triggered display, the displayed sweeps are cut out around the trigger event.)

- Zoom into a part of the displayed sweep by clicking and dragging the sliders with the **mouse**.
- Or select a slider with the mouse (a selected slider is highlighted in white) and move it by pressing the **LEFT** or **RIGHT arrow key**. For larger steps, press the **PAGE UP / DOWN key**.

Reverse Display

- Changes the display background color from **white** to **black**.

Automatic Zoom

Please click on the data display with the left mouse button. The following menu appears.

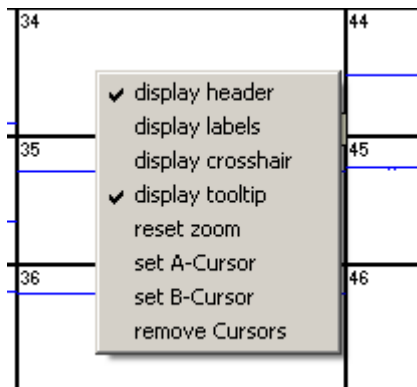

In raw data displays you can use an automatic zoom: Enable the "display tooltip" option. Now you can draw a rectangle by pressing the right mouse button. All data in this rectangle are zoomed. To reset the zoom, please click "reset zoom".

Additionally you have the options to display labels or a crosshair for measuring, or to set cursors and to remove them.

When pointing with the mouse on a data display, the accurate position will be displayed.

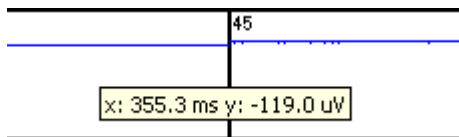

4.6.4 Peak Detection

In the **Data Display** and the **Spike Sorter** display, you can select the option **Peak Detection**. This option does only effect the display, not the data that is stored to the hard disk.

Peak Detection is a very important option. The massive amount of data points retrieved in the range of the time axis, 200 ms in this case, that means 500 data points at a sampling rate of 25 kHz, are reduced to a few pixels on the display, let us say to 100 pixels. That means, five data points are reduced to one.

Without **Peak Detection**, only every fifth data point is actually plotted. The other four are dropped. As you can imagine, it is likely that fast signals are overlooked or that you see peaks that are not actual present, but display artefacts.

MC_Rack Manual

With **Peak Detection**, the highest (max) and the lowest (min) value of the five data points are taken and connected by straight vertical line. Peaks are preserved in this way. On the other hand, this feature needs a higher computer performance for the internal data handling. You may want to deselect this option when you have a limited computer performance. The following error message appears when the system is at its limits.

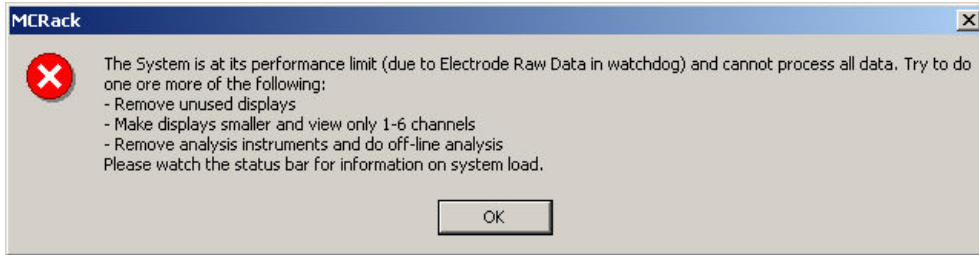

Without Peak Detection

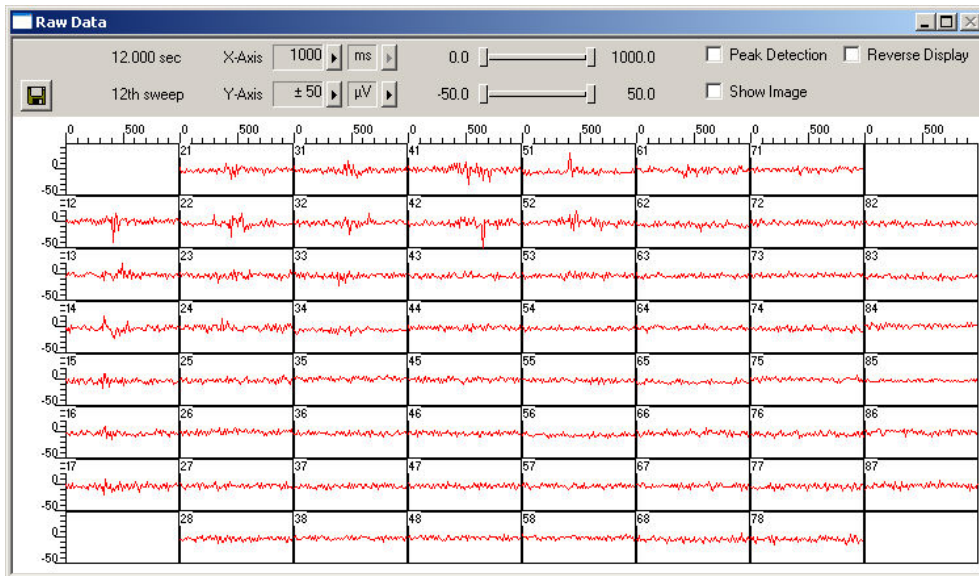

With Peak Detection

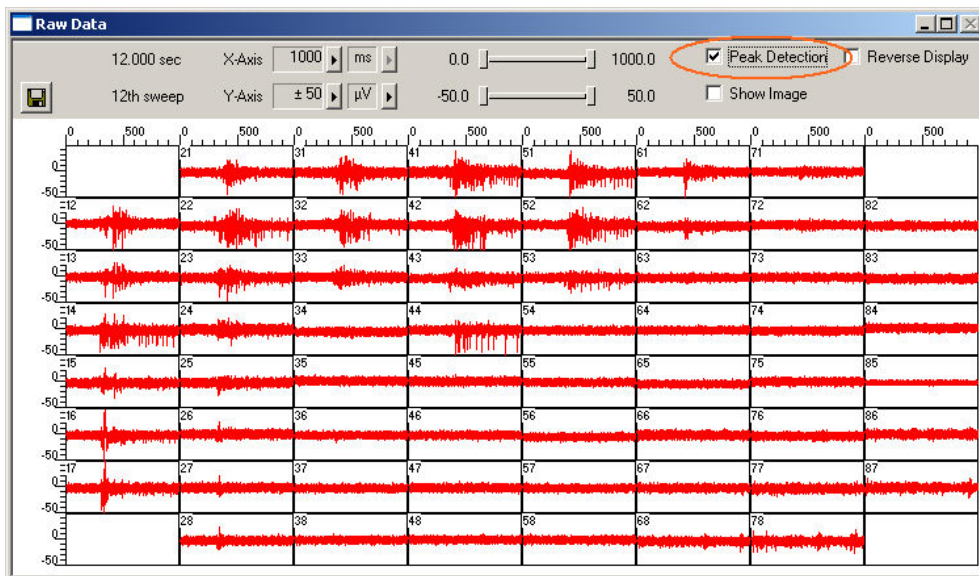

4.6.5 Customizing a Display

Showing and hiding the axes bar *

You can hide the axes bar on top of the display to save space and obtain a larger view of your data.

Right-click anywhere in the window and deselect **Display Header**.

Showing and hiding the data stream names *

You can show the data stream type of each channel.

Right-click anywhere in the window and select **Display Labels**.

Using the crosshairs *

Right-click anywhere in the window and select **Display Crosshairs** to show crosshairs. You can use the crosshairs to manually estimate peak heights and time points.

Customizing the display colors

Right-click either an axis or a trace to assign a new color to it. You can either choose one of the basic colors or define a custom color. You can assign a different color to each data stream. This is especially useful if you use a background picture or if you like to assign specific colors to specific kind of data.

(* = Available only for **Data Display**)

4.6.6 Displaying a Background Picture

You can load a photo of your preparation as a background picture to see which signals belong to which region of the preparation. This feature is only intended for MEAs with the standard 8x8 electrode grid. The file path is saved together with the data file when you record data after loading the picture. You can unload a picture again with the command **Unload Image**.

If you are using a MEA two-fold-System, you can load two images, one for each MEA (A and B).

If you are using a MEA four-fold-System, for example a MEA2100- or an USB-ME256-System, you can load four images, one for each MEA (A, B, C and D).

Note: File paths are absolute, that means MC_Rack cannot find picture files if they have been moved to another folder or directory. An error message will inform you in this case.

On the **File** menu, click **Load Image (MEA A)** for MEA A or **Load Image (MEA B)** for MEA B, and if available Load Image (MEA C) for MEA C, and Load Image (MEA D) for MEA D.

1. Select an appropriate image file and click Open.
2. Add a **Data Display** (or an **Analyzer** with display) to your rack. Select a MEA layout (A, B, C or D).
3. On the display, click Show Image. You can now see the picture.
4. Now, you map the channels to the electrodes in the picture. Hold down the SHIFT key, point to any electrode, for example, the top left, and double-click. A text box opens.
5. Type in the number of the electrode according to the MEA layout, for example 21.
6. Hold down the CTRL key, point to any electrode in another row, for example the bottom right, and double-click.

7. Type in the number of the electrode according to the MEA layout, for example 78. The data traces appear on top of the picture.

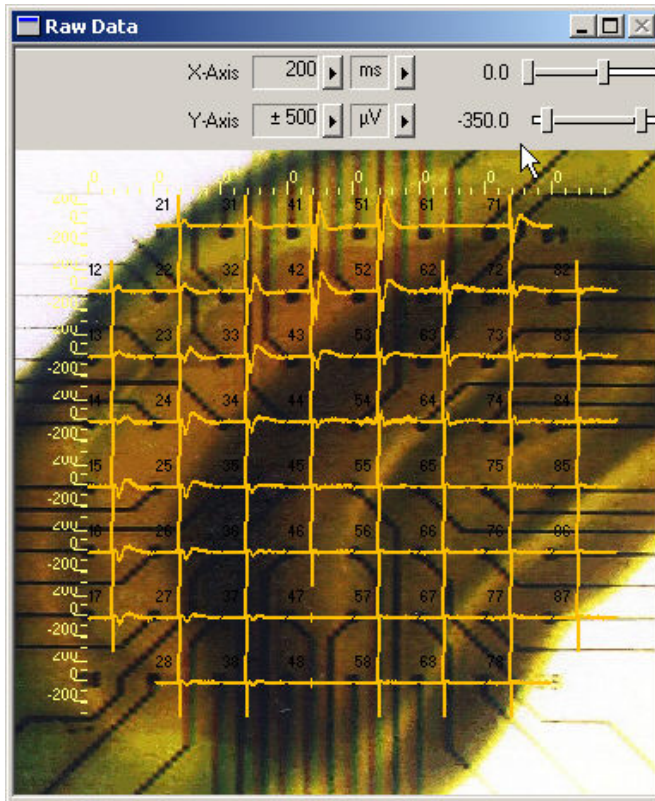

Hint: If you have made a mistake, simply repeat the assignment from step 5 to 7.

4.6.7 ASCII Export of Waveforms

Click  in the **display header** (not in main menu tool bar) to save the displayed data as a tab-delimited ASCII file (text without formatting). The format is tab-delimited ASCII, so that the file can easily be loaded into other applications. ASCII export is possible for all plot types.

You can open these files with an editor or with your custom analyzing software, for example Excel or Origin.

Exporting data is only possible when you have stopped the data acquisition or the Replayer. The **Save** button will then reappear on the toolbar.

You export all **displayed** data. A file is created for each channel separately. If you have zoomed to a single channel, only the visible channel is exported. The header of the ASCII table shows the channel numbers, the data type and the measuring units. The file name is automatically extended by the data stream name and the channel number. For example, if you export displayed data of channel 12 of the **Filtered Data 1** stream and enter MyData as a file name, the file name would be *MyData_filt0001_12*.

Data stream identifiers:

elec	Electrode Raw Data
angl	Analog Raw Data
digi	Digital Data
filt	Filtered Data
spks	Spikes
trig	Triggered Data

Please see the description of the plot types for more details.

4.7 Data Display (for Monitoring Raw Data)

4.7.1 Plot Types

Click  to add a **Data Display** to your rack. You can choose between different **plot types**, depending on the data stream type. When displaying Raw Data, only the **Trace** plot is available.

- **Trace** plot: The voltage traces are plotted.
- **Overlay**: Spike cutouts are overlaid.
- **Raster** plot: The detection events of spikes are plotted. Use this plot type to make spike patterns visible, for example in relation to a stimulus.

4.7.2 Trace Plot

- The voltage traces are plotted. This plot type is generally used to view Electrode Raw Data, Analog Raw Data, or mixed data streams.

ASCII Export

The created **file** has the following **structure**.

- The **first column** is the **x-axis (time)**.
- The following column is the y-axis (voltage).
- The first row contains the column headers.
- The **second row** are the **measuring units**.
- The following rows contain the data.
- The following screen shot shows such a file opened with a standard spreadsheet.

T	elec0001 04		
[s]	[μ V]		
0.00004	-190000		
0.00008	-128000		
0.00012	-32000		
0.00016	-92000		
0.0002	-118000		
0.00024	-86000		
0.00028	-72000		
0.00032	-134000		
0.00036	-130000		
0.0004	-168000		

4.7.3 Overlay Plot

- For plotting spikes. Spike cutouts are plotted over each other, aligned to the detection event. You can set the number of spike cutouts to be overlaid (up to 1000). The overlay plot is useful to compare waveforms. It can be used to estimate the variability of signals or to detect multi-unit activity.

ASCII Export

The created **file** has the following **structure**.

- The **first column** is the **x-axis (time)**.
- Each following column represents a **sweep**, in the order of plotting, that is the first column contains the first sweep, and so on.
- The **first row** specifies the **Spike Sorter tags**. Untagged sweeps are specified by Unit = 0. Sweeps can be tagged by units 1 to 3.
- The **second row** are the **measuring units**.
- The following rows contain the data.
- The following screen shot shows such a file opened with a standard spreadsheet.

T	Unit=0	Unit=0	Unit=0	Unit=0
[s]	[μ V]	[μ V]	[μ V]	[μ V]
0	-2.66667	9.333334	5.333333	-2.66667
0.00004	-2.66667	8	6.666667	
0.00008	-5.33333	9.333334	6.666667	-1.33333
0.00012	-5.33333	9.333334	6.666667	
0.00016	-1.33333	10.66667	5.333333	-1.33333
0.0002	-1.33333	10.66667	6.666667	-2.66667
0.00024	-1.33333	10.66667	5.333333	-2.66667
0.00028	0	9.333334	4	-1.33333
0.00032	0	10.66667	4	-1.33333
0.00036	-1.33333	8	1.333333	1.33333

4.7.4 Raster Plot

- For plotting time points of spike detection events. Detection events are plotted as vertical lines arranged in rows, that means, only information about the time course, but no information about the amplitude is provided. The length of a single row is defined by the range of the x-axis. The latest sweep is plotted on top of the plot; and all previous sweeps are shifted downward. You can use the **Raster Plot** to visualize spike patterns, especially for triggered data.
- You can set the number of plotted sweeps, up to 1000.

In the following screen shot, you see a regular spike pattern (continuous data).

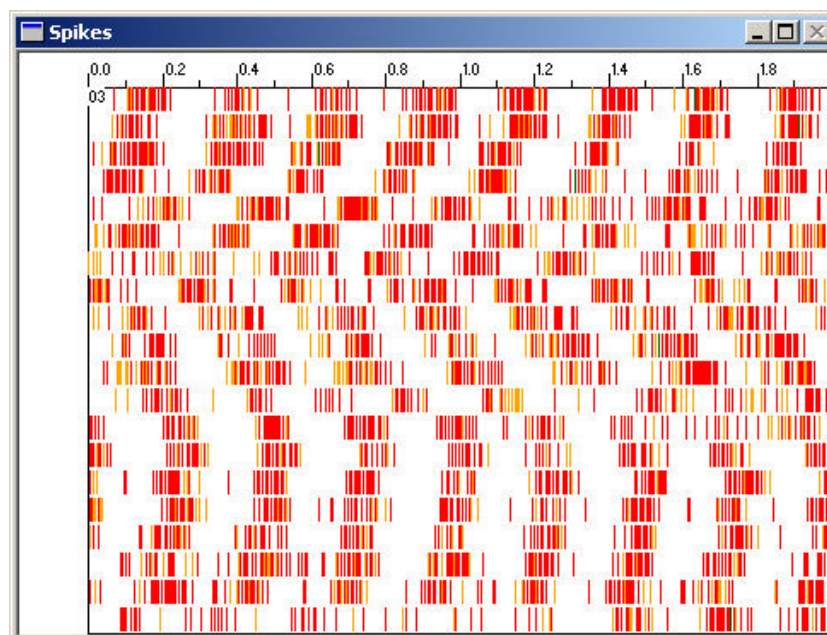

Using a raster plot

The **Raster** plot is only available for spike data streams. Make sure you have a **Spike Sorter** in the rack, or replay a data file containing spike data streams.

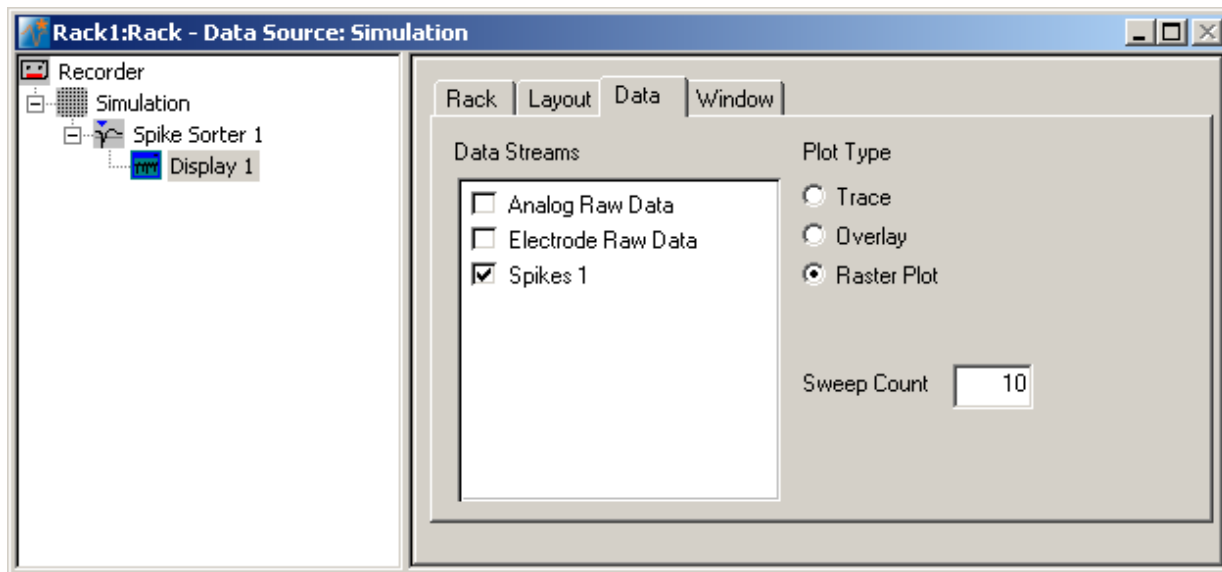

1. Add a **Data Display** to your virtual rack configuration (in serial with the **Spike Sorter**).
2. Click on the **Display** in the virtual rack tree pane to select it.
3. Click the **Data** tabbed page of the **Display**. Select only the **Spikes** data stream.
4. Select the **Raster Plot** option.

ASCII Export

The created **file** has the following **structure**.

- The **first column** is the **x-axis (time)**.
- The **second column** is the **sweep number**. The first sweep (on the bottom of the plot) is sweep number 0, all other sweeps are counted up.
- The **third column** specifies the **Spike Sorter tags**. Untagged sweeps are specified by Unit = 0. Sweeps can be tagged by units 1 to 3.
- The first row contains the column headers.
- The **second row** are the **measuring units**.
- The following screen shot shows such a file opened with a standard spreadsheet.

T	Row	Unit		
[s]				
0.01332	9	0		
0.0174	9	0		
0.02904	9	0		
0.0404	9	0		
0.0428	9	0		
0.05992	9	0		
0.06488	9	0		
0.0966	9	0		
0.10212	9	0		
0.10984	9	0		

4.8 Digital Display (for Monitoring TTL Inputs)

4.8.1 Displaying Digital Data

The **Digital Display** is used to view either the logical state of the 16 digital channels, or to display the 16-bit encoded decimal number of the binary data (see "Numeric Display"). It is only available if the data source you are currently using produces a Digital Data stream. The **Digital Display** has features similar to the **Parameter Display** type. For more information on the toolbar, or how to zoom channels, please refer to the topic "Parameter/Digital Display Tools".

→ On the **Edit** menu, click **Add Digital Display** OR click the according button  on the toolbar - OR - press CTRL+G on your keyboard to add a **Digital Display** to your rack.

Selecting bits

You can choose the bits you like to display.

1. Select the **Digital Display** in your rack.
2. Click the **Settings** tab.
3. Select all bits you like to view in the **Digital Display**.

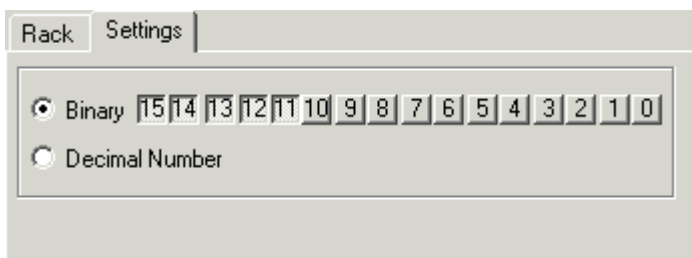

The display now shows the logical state (0 or 1) of the selected bits.

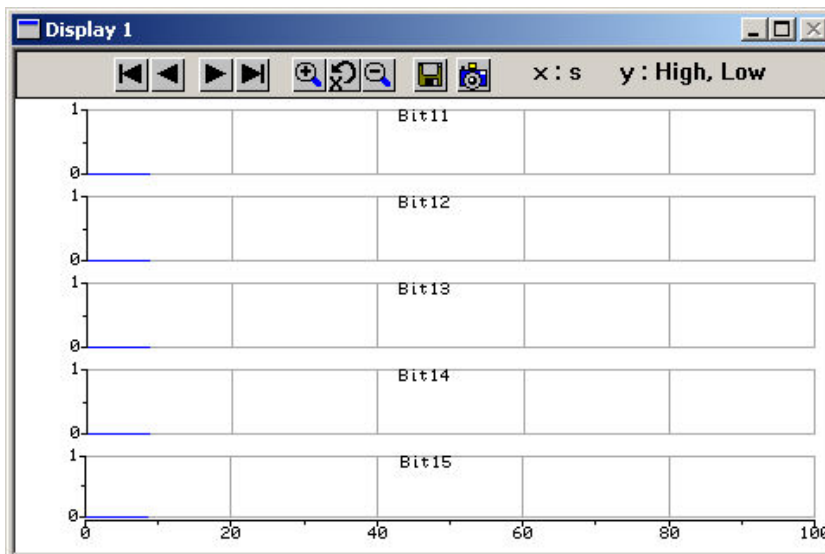

4.8.2 Numeric Display

Instead of plotting the logical state of the binary data (bits), you can choose to display the 16-bit encoded decimal value. The numeric display is used for special applications, for example, to display slow digitized data from an analog data source. It is not recommended for pulses that are faster than the refresh rate of the display. Instead, use the **Binary** view to see the traces of fast triggers.

See "About Digital Data and Binary Code" for MC_Rack Features.

1. On your rack, click the **Digital Display**.
2. Click the **Settings** tab, and then click **Decimal Number**. The **Digital Display** is empty now. If you click **Start**, the actual decimal value based on the 16-bit binary value of the digital data stream is displayed.

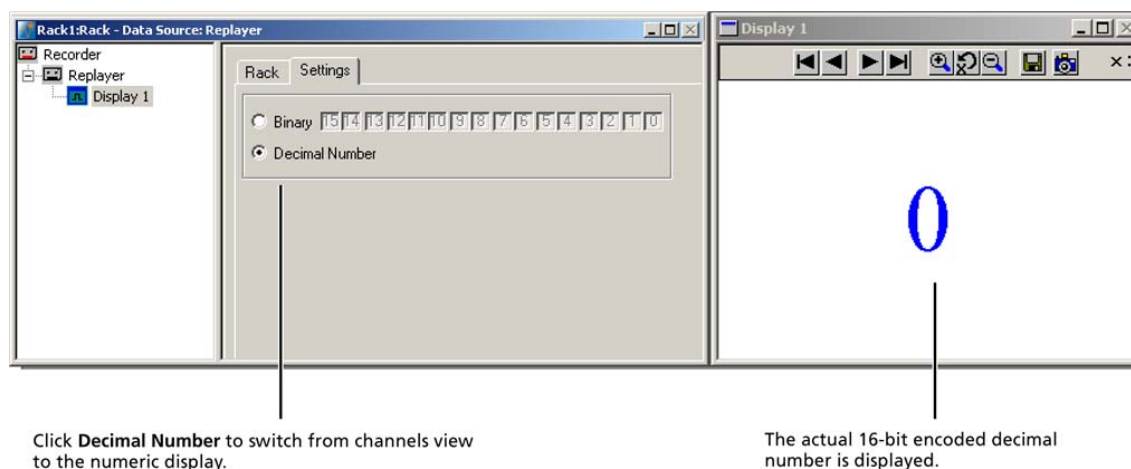

4.9 Trigger Detector

4.9.1 Using the Manual Trigger

The function "**Manual Trigger**" allows the user to generate a **trigger event** manually from within MC_Rack. This can be used to create timestamps in a data file. Manual triggers can only be generated during online data acquisition, and only in continuous mode. Manual triggers are intended to mark external events like changing perfusion solution, turning on or off a pump, changing temperature or similar events.

These triggers can **NOT** be used to mark specific signals, as the manual trigger will be generated in real time when the button is pressed, but the signal displayed in MC_Rack is approximately one second behind real time.

To use the manual trigger, insert a "Trigger Detector" in your rack and select "Manual Trigger" from the bottom of the list in the "Channel" drop down menu. To generate a manual trigger, press the "Trigger" button below the Channel drop down menu or the manual trigger icon in the main menu toolbar. Each timestamp generated with the manual trigger will be counted up, and stored in the "*.mcd" file. You just have to note which event is correlated with manual trigger 1, 2, 3 etc.. When replaying the marked data file in replayer mode, the manual trigger events will always be shown on one channel of the display only: Using the MCS default two dimensional channel map, the marker will appear on channel 47, in one dimensional channel layout on channel 1.

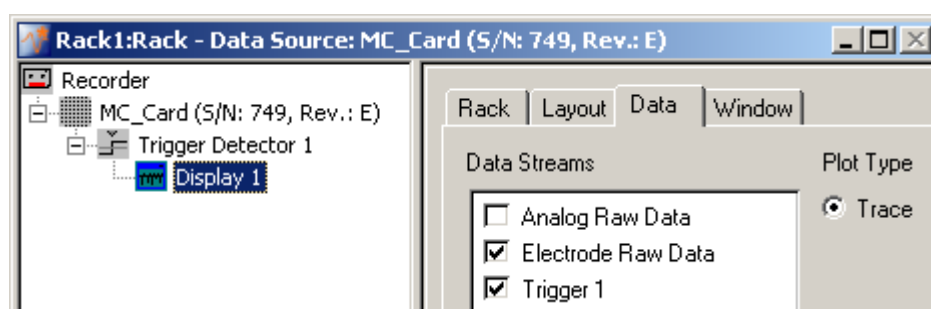

Click trigger detector icon  or select in main menu Edit "Add Trigger".

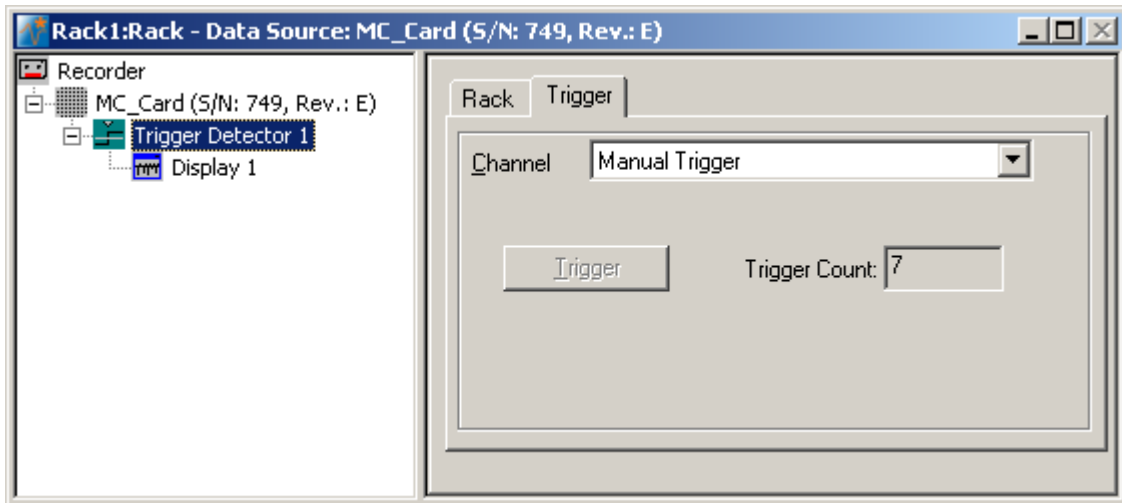

MC_Rack Manual

Click Trigger tab. Select "Manual Trigger" from the Channel drop down menu.



When MC_Rack is displaying or recording data, the button "Trigger" is active. The number of user defined trigger events will be counted up in the small display "Trigger Count". Alternatively to the Trigger button in the Trigger dialog, you can also use the manual trigger icon in the main menu toolbar  to generate a manual trigger timestamp. Immediately after clicking the button "Trigger" or after clicking the icon, a symbol for the timestamp and its number  will appear in one channel of the display. Using the MCS default two dimensional channel map, the marker will appear on channel 47, using the one dimensional MCS default channel map, the marker appears on channel 1.

For displaying and recording the trigger events, please select the continuous mode in "Window" tab of recorder.

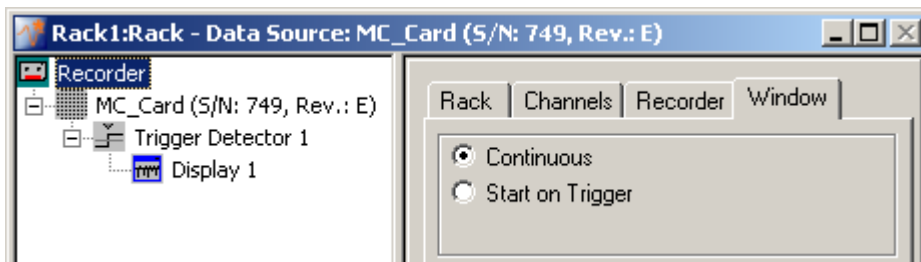

To record the time stamps created with the manual trigger, make sure to select the Trigger data stream in the "Channels" tab of recorder.

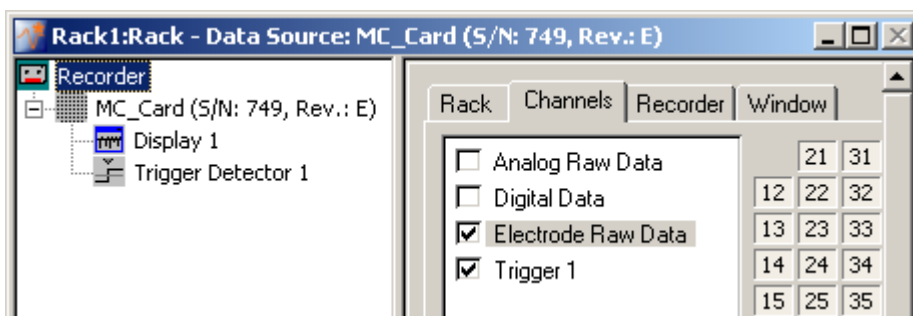

To display data and manual trigger, please select the desired data streams in the "Data" tab of the display. The display has to be placed in dependency of the Trigger Detector 1 in the virtual tree.

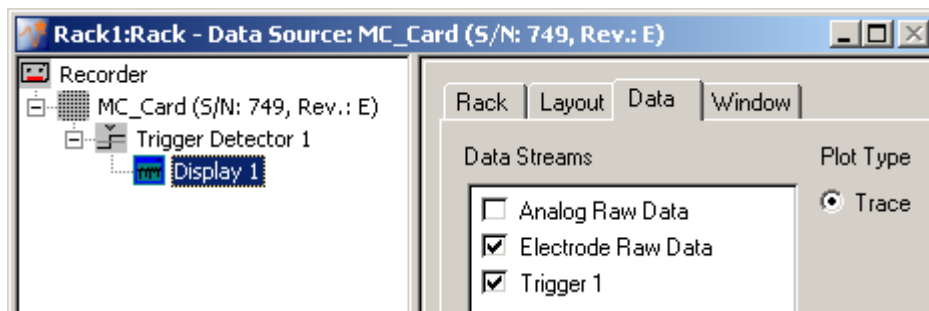

When replaying a Rack file with manual trigger events, the timestamp and its number will appear in one channel of the display. Using the MCS default two dimensional channel map, the marker will appear on channel 47, using the one dimensional MCS default channel map, the marker appears on channel 1.

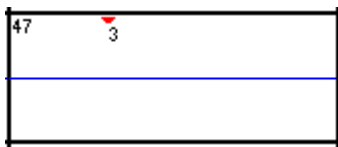

Important: The manual trigger is enabled, when MC_Rack data acquisition is running only!

Important: The manual trigger is enabled in continuous mode of recording!

4.9.2 Triggering MC_Rack

The **Trigger Detector detects** trigger events on a **single** input channel and **generates** a Trigger data stream that can be used to trigger other virtual instruments, for example, to control the **Recorder** or an **Analyzer**. Several Trigger streams can be generated by separate **Trigger Detectors**. You can use Electrode or Analog Raw Data, Filtered data, Parameter, or Digital Data streams as input streams for trigger detection.

- You can define a bit pattern for using digital signals (TTL pulses) as a trigger.
- You can define a threshold for triggering on biological signals.
- You can define a threshold for triggering on extracted parameters.
- You can also program an automatic time-based trigger.

4.9.3 Triggering on TTL Pulses

The digital input channel is generally used for synchronizing the (USB) MEA- or ME-System to a stimulus generator, or to another data acquisition system, for example, an imaging or a patch clamp system. In MEA2100-Systems the STG is integrated. Only TTL signals are accepted as input signals on the digital input bits. You can apply TTL pulses to single digital input bits, or you can encode a bit pattern by combining multiple digital input bits.

Important: The applied TTL signal should not be too short, depending on the sampling rate, for example, it should be at least 40 μ s at a sampling rate of 50 kHz. Otherwise, it can happen that the MEA2100-System, the MC_Card or the USB based data acquisition miss signals.

Detecting a trigger in the digital data stream

Click a **Mask** button to select a channel.

Use the **Bit** buttons to define the state of each channel:
 Pressed in = High
 Not pressed in = Low

Specify whether the decimal value of the bit combination has to be smaller or greater than, or equal to the specified binary number to trigger an event.

Time interval after a trigger event in which no new trigger event will be accepted.

You can select the digital input channels that will be used by the **Trigger Detector**. All other channels are masked, that is, are not considered at all. Click a **Mask** button to select an input channel. For example, in the preceding screen shot, TTL signals are accepted only on the digital channel 0. All other channels are masked.

This is very important if you do not have all 16 channels in use that is, connected. Open (not connected) channels do not automatically have a logical state of 0, even though there is no input signal. They are in an undefined state, that is, it is not known whether they have the logical state 0 or 1, and they can also switch to the other state without an input signal (depending on electrical noise, air moisture, and so on). Therefore, it is recommended that you select only those channels that you have actually connected. Unused input bits should be masked.

You have to preset the state of each selected bit by using the **Bit** buttons. Each channel can have either the state **High (1)** or **Low (0)**. If a **Bit** button is pressed in, the input signal on the according digital channel has to be high (5 Volts). Otherwise, if a bit button is not pressed, the signal has to be low (0 Volts). The bits of all channels are combined by the logical operator AND, that is, all states have to be true to trigger an event. For example, if bit 0 is set to Low and bit 1 to High, a trigger event is detected when bit 0 is low and bit 1 is high at the same time.

A simple way of triggering would be to apply a signal to one or more channels (for example, from the Sync Out of a stimulus generator (STG)). But it is also possible to encode more information from external devices in binary code. For those applications, you can set the **Type** to **Less than (<)**, **Equal to (=)**, or **Greater than (>)**. This specifies whether the **decimal value** has to be less than, equal to, or greater than the specified bit combination to trigger an event.

Remember that TTL input signals are only accepted on those input bits that are selected with the **Mask** buttons. The state of the other (masked) bits can be arbitrary. For example, if you select only bit 0 and set it to High, all situations where bit 0 is High will trigger an event. In the example, all odd numbered decimal values will trigger an event, because, if a decimal number is odd, bit 0 always has the state High (=1). See "About Digital Data and Binary Code" for more information on the subject.

Multiple trigger inputs

You can set up several trigger detectors that respond to separate trigger inputs. For example, for a paired pulse experiment, you can trigger one **Analyzer** on bit 0 (for example, connected to Sync Out 1 of an STG 2000 series), and the other on bit 1 (connected to Sync Out 2).

4.9.4 Triggering on Biological Signals

You can define a **threshold** for triggering on biological (analog) signals from Analog Raw Data, Electrode Raw Data, or Filtered data streams.

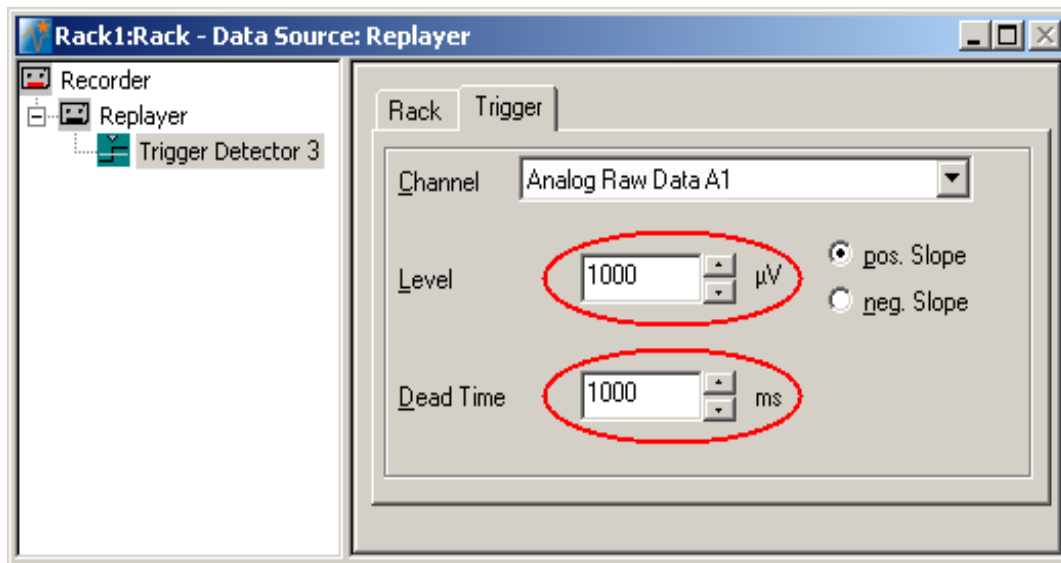

- Select the appropriate data stream and channel from the **Channels** list.
- If you select the option **Negative Slope**, the fall of the curve is regarded. If you select **Positive Slope**, the rise is considered.

The following picture illustrates how the trigger detection works.

Trigger detection

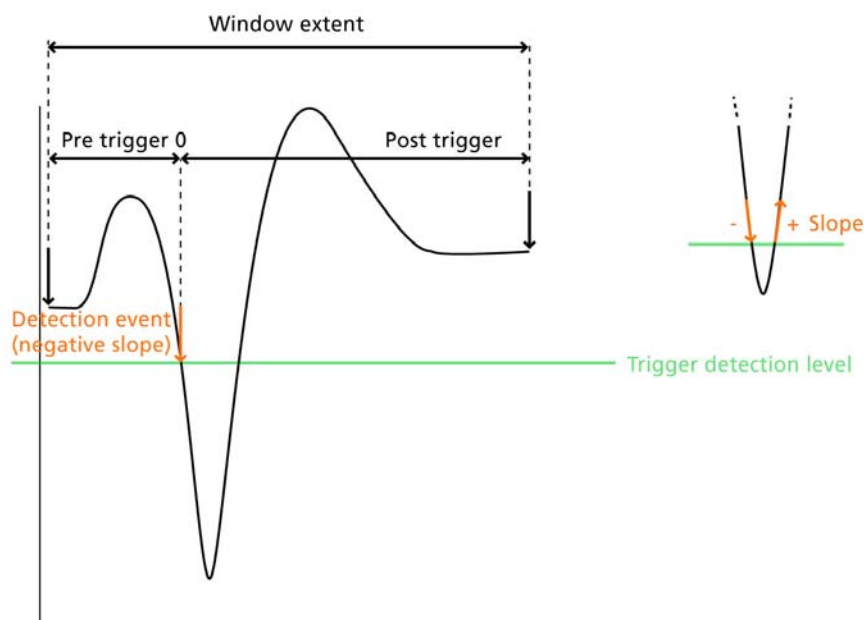

If you use the Trigger data stream that is generated by the **Trigger Detector** to control other virtual instruments, the trigger event is considered at the time point = 0. You can then define how long before the trigger event (pre-trigger time) the instrument (an **Analyzer**, for example) will start and how long after the trigger event (post-trigger time) the instrument shall stop. The total time gives you the window extent. You define these settings on the **Window** page of an instrument. See also "Triggered Data".

4.9.5 Triggering on Extracted Parameters

Similar to the triggering on raw data streams, you can also define a **threshold** for an extracted parameter stream to generate trigger events. For example, you can trigger the recording only if the spike rate reaches a threshold level.

Triggering on a parameter stream

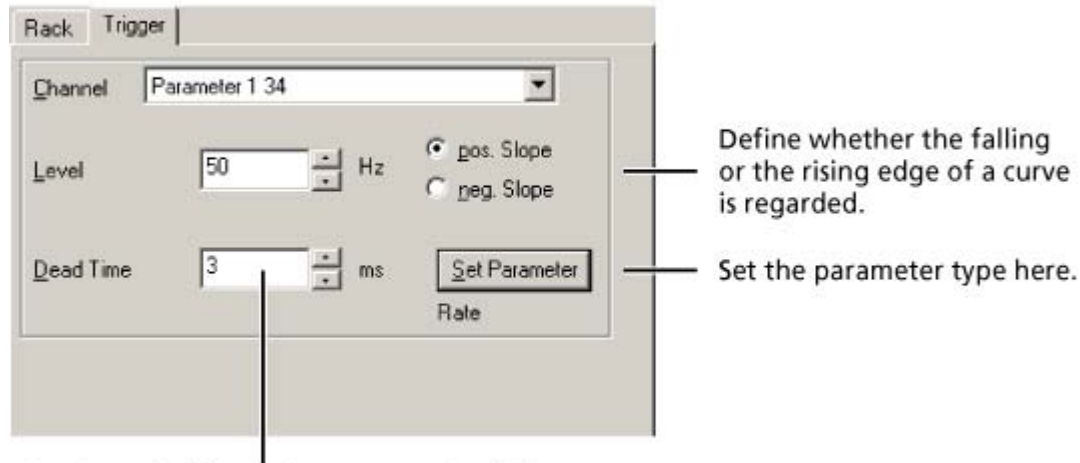

Time interval after a trigger event in which no new trigger event will be accepted.

- Select the appropriate parameter data stream and channel from the **Channels** list.
- If you select the option **Negative Slope**, the fall of the parameter curve is regarded. If you select **Positive Slope**, the rise is considered.
- If you use a Parameter stream with multiple extracted parameters you have to specify the **parameter type** as well.

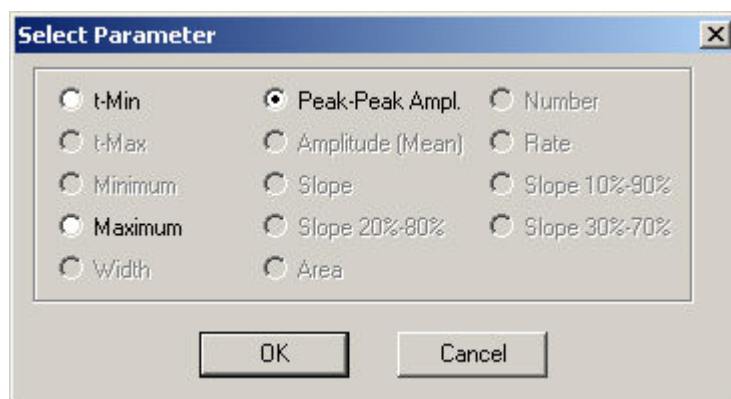

4.9.6 Time Based Trigger

You also can define a **time-based** trigger. The trigger event can either occur periodically or at specified points of time. For example, you can use this feature if you want to apply a drug at specific time intervals and want to record data only at the drug application times.

Single or periodic trigger event

Programming a periodic time-based trigger

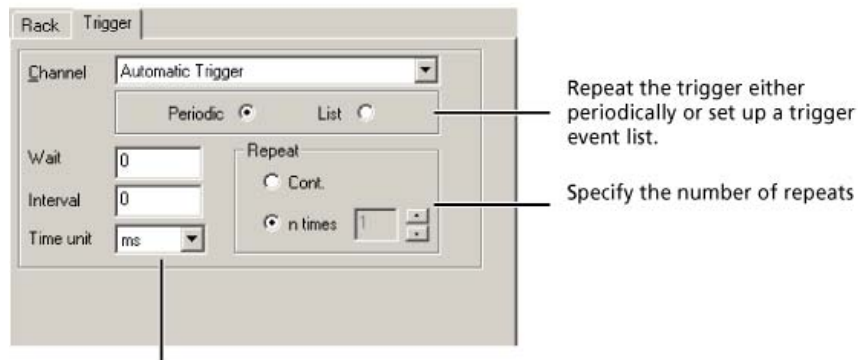

Set the start time and the time interval for the trigger events

If you use a periodic trigger, you define the start time (**Wait**), when the trigger occurs the first time, and the time **interval**, when the trigger will reoccur after an event. You can choose whether the trigger shall occur a fix number of times, or whether it shall occur continuously (option **Cont.**).

Predefined list of trigger events

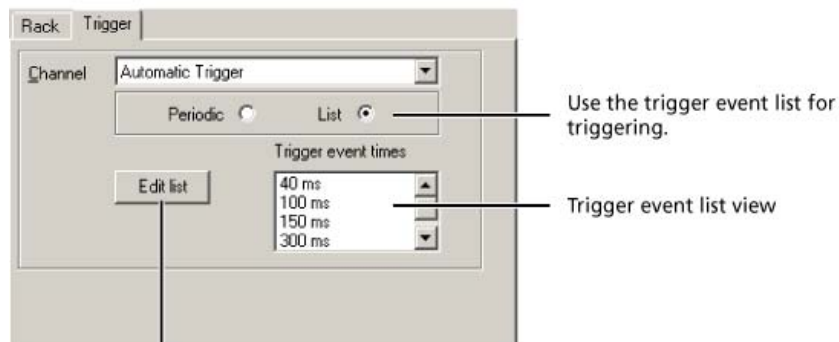

Setting up a trigger event list

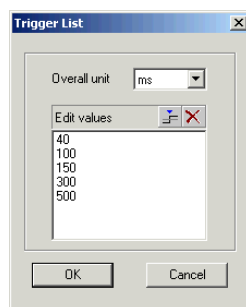

Click **Edit List** to set up or modify the list.

1. If you want to use predefined trigger times, select the option **List**.
2. Click **Edit List** to set up a list of trigger events. The **Trigger List** dialog box appears.



3. Select the **time unit**.
4. Click the **New Trigger Value** button  to enter a value.
5. Select an entry in the list and click the **Delete Value** button  to remove the selected trigger event from the list, if necessary.
6. Click **OK** to complete the list and close the dialog box.

4.10 Automatic Feedback

4.10.1 Digital Output

To use this feature, you need a MEA2100-System, an USB based data acquisition device and when using the MC_Card a Dig Out connector for your computer and the MC_Card driver version 2.5 or higher.

You can use the **Digital Output** instrument to apply a feedback triggered by a signal or a parameter stream. Set up a **Trigger Detector** first. You can then use the generated trigger to apply a digital pulse via the digital output channels of the MEA2100-System or an USB based data acquisition device or the MC_Card. You can use this output signal to trigger an external device, for example, a stimulus generator that applies a feedback stimulus to the test model.

The pulse is a 20 ms TTL signal. See also "About Digital Data and Binary Code". The timing is not real-time based, that means the feedback event may vary. The typical internal delay between the trigger event and the TTL pulse is about 300 ms. You can add a custom delay to this internal error.

The digital output signal cannot be processed further by other virtual instruments or displayed directly in MC_Rack. But you can connect the digital output of the data acquisition to the digital input of the data acquisition. You can then add a **Digital Display** to see the digital input signals, which should be identical to the output signals.

Digital Output

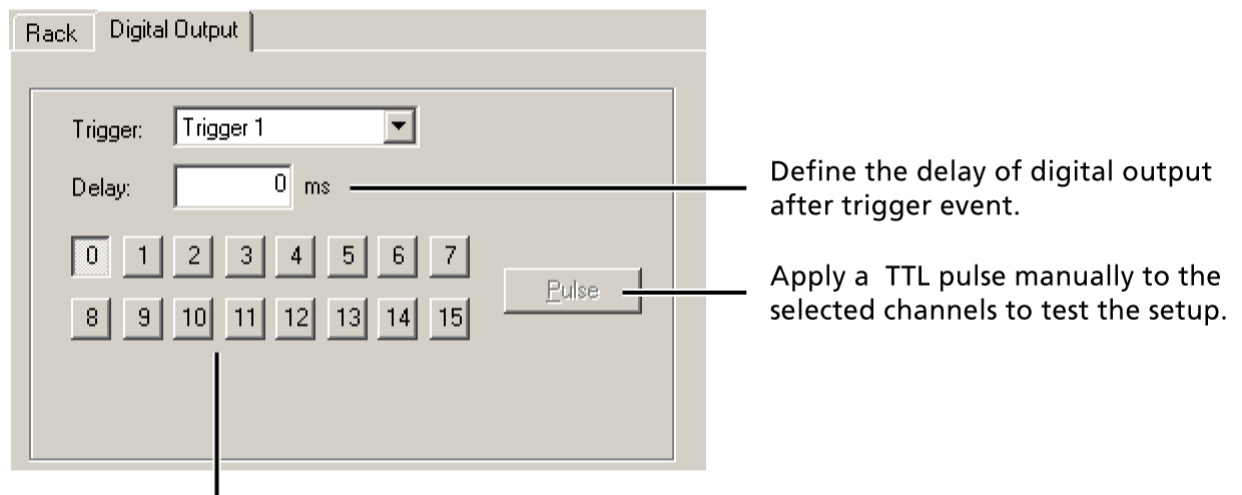

Select the digital output channels.

1. Add a **Trigger Detector** to your virtual rack, select a data stream, and set a trigger detection level.
2. On the **Edit** menu, click **Add Digital Output** to add a **Digital Output**  to your rack.
3. Click the **Digital Output** tab and select the **Trigger** data stream, if you have more than one **Trigger Detector** in use.
4. Select any bits of your choice. A TTL signal (logical state 1) will be applied to all digital output channels that are selected. Selected bits appear pressed in.
5. Type a number in the **Delay** box. The digital signal will be applied after the trigger event with the specified delay plus the internal time delay of about 300 ms.
6. Start the application by clicking **Start** on the measurement menu.

4.11 Real-time Feedback

4.11.1 Real-time Feedback

Introduction

The real-time feedback feature represents a significant improvement in signal detection and processing. Previously, the digitized signals were processed by the computer's main processor, which involved the operating system and resulted in unpredictable and rather long delays between the actual event and its' detection. With the new generation of USB based data acquisition systems from MCS, online filtering, signal detection and generation of feedback signals are realized by a **Digital Signal Processor (DSP)** in the data acquisition hardware. It is now possible to reliably generate a feedback signal within a time frame of one millisecond after the actual event.

The main purpose of this feature is to allow the user to generate TTL signals in response to defined signal patterns detected by one or several electrodes. These TTL signals in turn can control a stimulus generator (STG) to deliver **feedback stimulation** to the biological sample. It is also possible to use the TTL for example, to activate an imaging system, or control a drug application device.

The real-time feedback function consists of four components: **Online filtering, signal detection, feedback logic, and generation of a digital TTL feedback signal**. The filtering is optional; you can use a high pass, a low pass, or a band pass filter on your data. The signal detection works either on the raw data or on the filtered data stream. Signal detection works by an individual threshold that can be adjusted for each electrode. After the signal detection, the user can define the conditions that will trigger a TTL signal by a feedback logic. Either single events or event rates on one or several electrodes combined can be set as condition to trigger a TTL signal. 16 digital output channels are available, each of which can be activated by a different signal condition. Events from the same electrode can be used in more than one logical block. The following scheme illustrates the principle of real-time feedback processing.

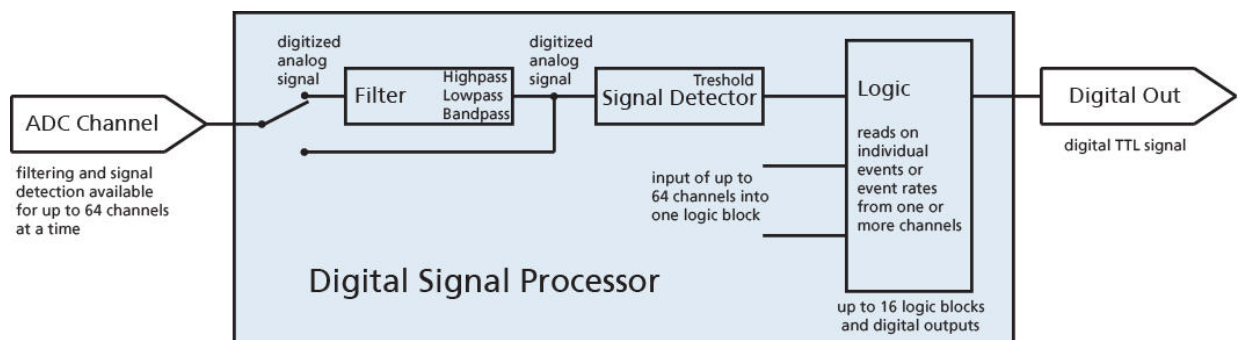

Limitations

Real-time feedback is available only for **advanced data acquisition systems** like MEA2100-Systems, USB-MEA- or USB-ME-Systems. It is not available with MC_Card data acquisition or in simulation mode. Furthermore, a **firmware update** and **MC_Rack version 4.0 or higher** is required. Due to the performance limitations of the Digital Signal Processor (DSP), online filtering and signal detection are limited to 64 channels at the moment. If you have more than 64 channels, it is necessary to select a maximum number of 64 channels at a time for real-time processing.

MEA2100-Systems with the exception of the MEA2100-32-System are equipped with an additional DSP which allows programming from extern. You can feed in individual adapted signals for your individual designed experiments.

Setting up the Hardware

To generate real-time feedback stimulation to a biological sample, you need an advanced data acquisition system (MEA2100-System, USB-MEA- / ME-System), and a stimulus generator STG. The digital output channel of the data acquisition has 16 bits. Bit 0 is accessible directly via Lemo connector. In MEA2100-Systems bit 0 to bit 3 are separately available via Lemo connectors, but you do not need a cable connection, because of the internal 3-channel STG. If you work with more than one bit in USB-MEA- / ME-Systems, you need the Digital In / Out Extension (Di/o). This device gets connected to the Digital IN / OUT of the data acquisition and provides access to all 16 input and 16 output bits via standard BNC connectors.

Each output bit of the digital channel can be connected to one or more Trigger IN connectors of a STG. Please see the STG manual on how to start stimulation on the Trigger IN.

Important: It is a requirement to select the check box "Digital Input" in "Channel Layout" of the "Data Source Setup". Otherwise the real-time feedback feature is not available!

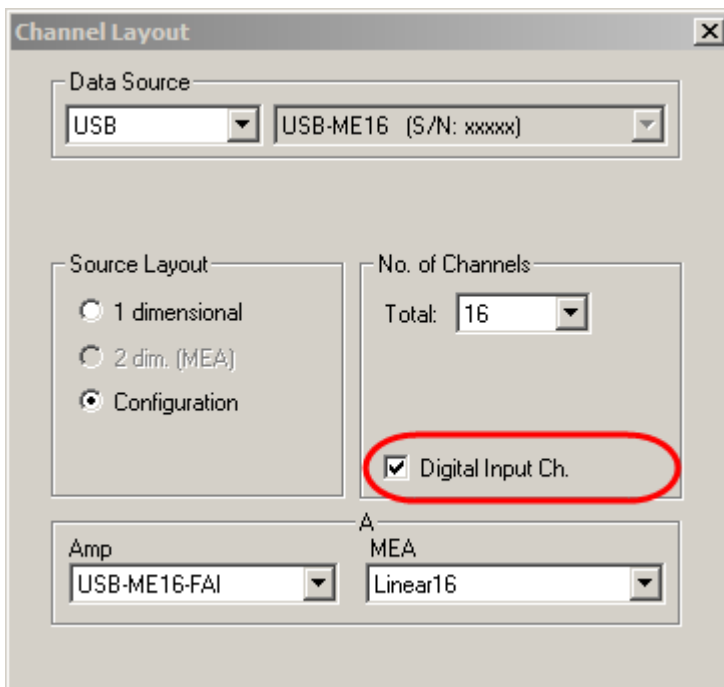

Important: The feedback signal from the processor module will be sent to digital outputs and digital inputs as well. The DIG OUT is used for the connection to the STG. The respective DIG IN channels can be used to monitor the generated feedback signals with a digital display in MC_Rack. Therefore you can not apply external digital input signals to the DIG IN bits in use.

Setting up the Software

Click Edit menu and add "**Real-time Feedback**" or click the real-time feedback icon  in the toolbar.

The real-time feedback tool **automatically** opens a **display window**, which will show the **raw data or data filtered by the digital hardware filter** of the real-time feedback tool, the **spike detection level** and the **TTL feedback signal**. The starting point of the trigger is marked by the small red triangle above. The duration of the trigger is indicated. You can change the color of the signal traces with a right click onto the trace as usual. Spike detection thresholds of individual electrodes can be adjusted by moving them with the mouse in the display window. In the example shown below, a 5 ms TTL is generated in response to every detected spike.

The **data trace** (blue), the **detection level** (black), and the generated **TTL pulses** (red) are displayed in one window. It is possible to toggle the display window in the "Digital Hardware Filter" tab.

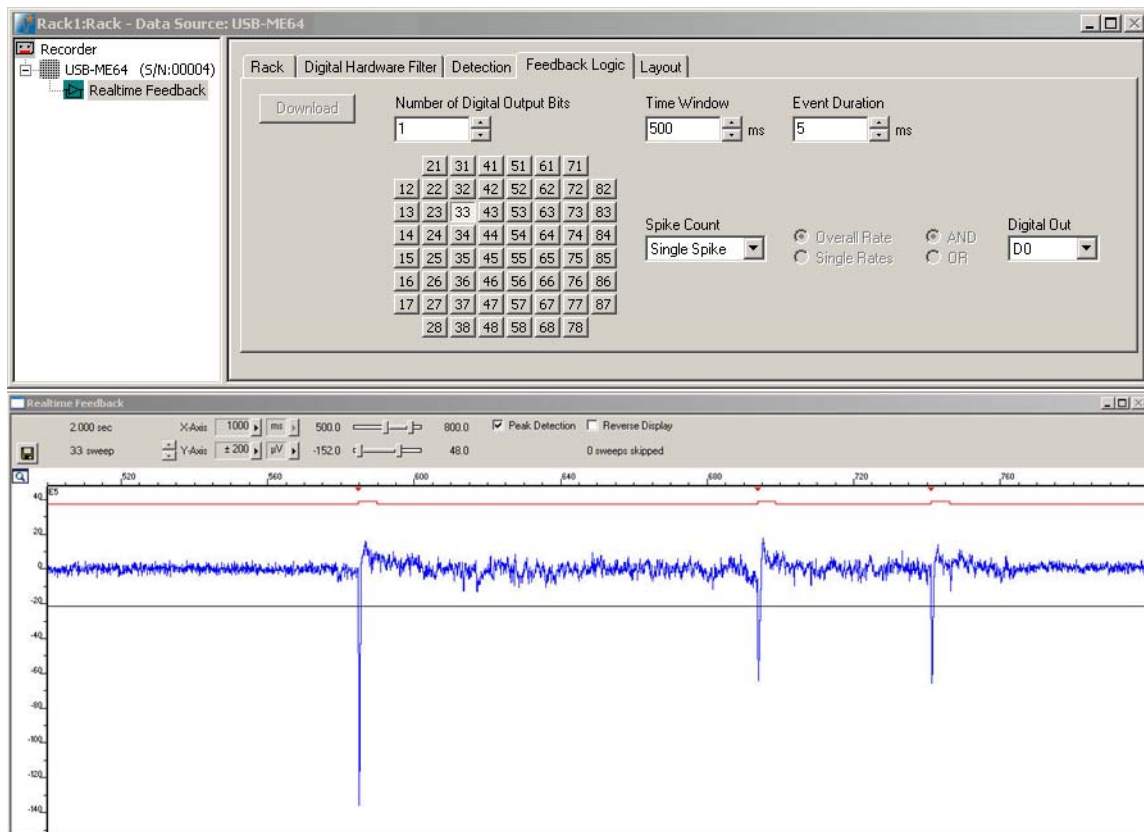

The real-time feedback has to be the **topmost tool** in the hierarchical order of MC_Rack program below the data source, because the raw data stream is influenced by the digital hardware filter of the DSP. MC_Rack processes this data stream only, and so do all instruments and the recorder. However, it is possible to generate feedback on a filtered data stream, but still record the raw, unfiltered data (Please see "Digital Hardware Filter" tab.)

MEA2100-System

The "Feedback Logic" tab of the dialog is different for MEA2100-Systems with internal stimulator.

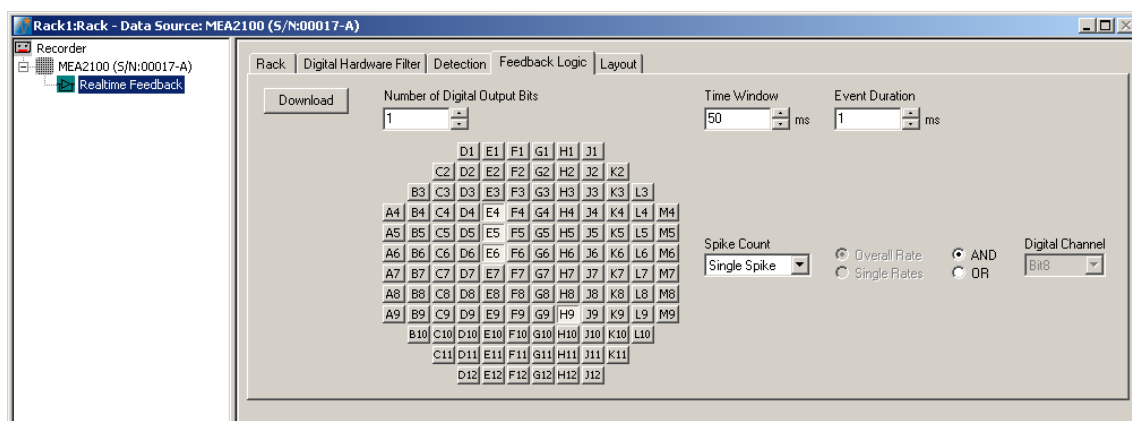

MC_Rack Manual

When recording with a MEA2100-System, the digital display is labeled: The first four rows display the "DigIn" channels for bit 0 to bit 3. The next three rows show the "Blanking" signal 1 to 3 on bit 4, bit 5, and bit 6. "Zero" is associated with bit 7. The following rows display the "RF" real-time feedback associated to bit 8 to bit 16 on channel 1 to 8.

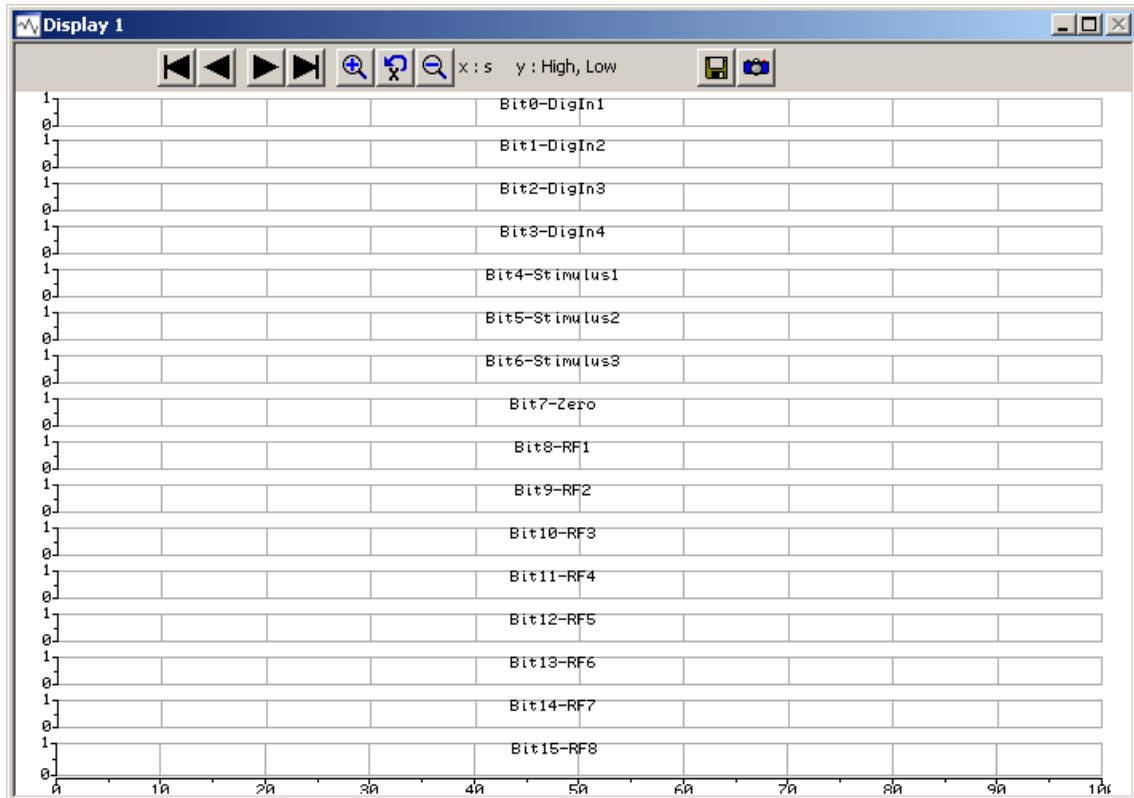

To record the digital stream, created via real-time feedback, please enable the respective checkbox in the "Channels" tab.

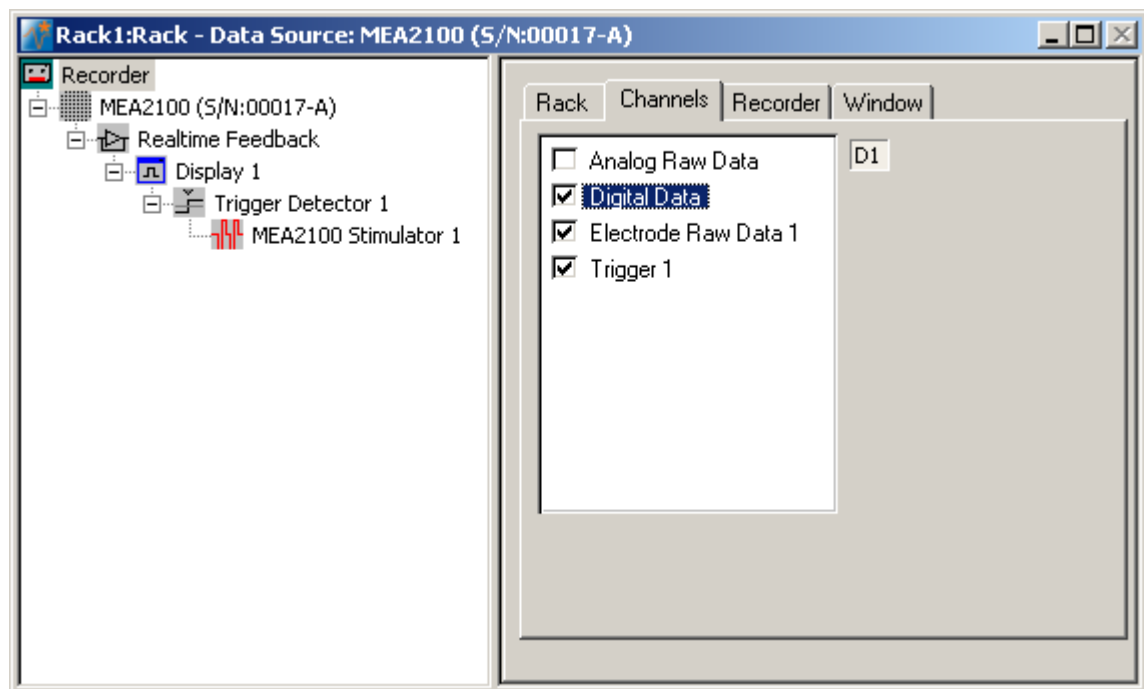

Digital Hardware Filter

In the "Digital Hardware Filter" tab, it is possible to switch the real-time feedback feature on and off, and to define the characteristics of the digital hardware filter that gets applied to the data before it goes through the signal detection algorithm. Using a **filter is not obligatory** for real-time feedback. It needs Digital Signal Processor (DSP) resources and time for calculation. The **digital filter shifts the signal** by some samples, so the real-time feedback is delayed about eight times the sampling rate, for example 200 μ s for 40 kHz sampling rate, compared to the time without filter.

The filter is applied to all channels, whereas further processing is restricted to the channels selected in the "Feedback Logic" tab.

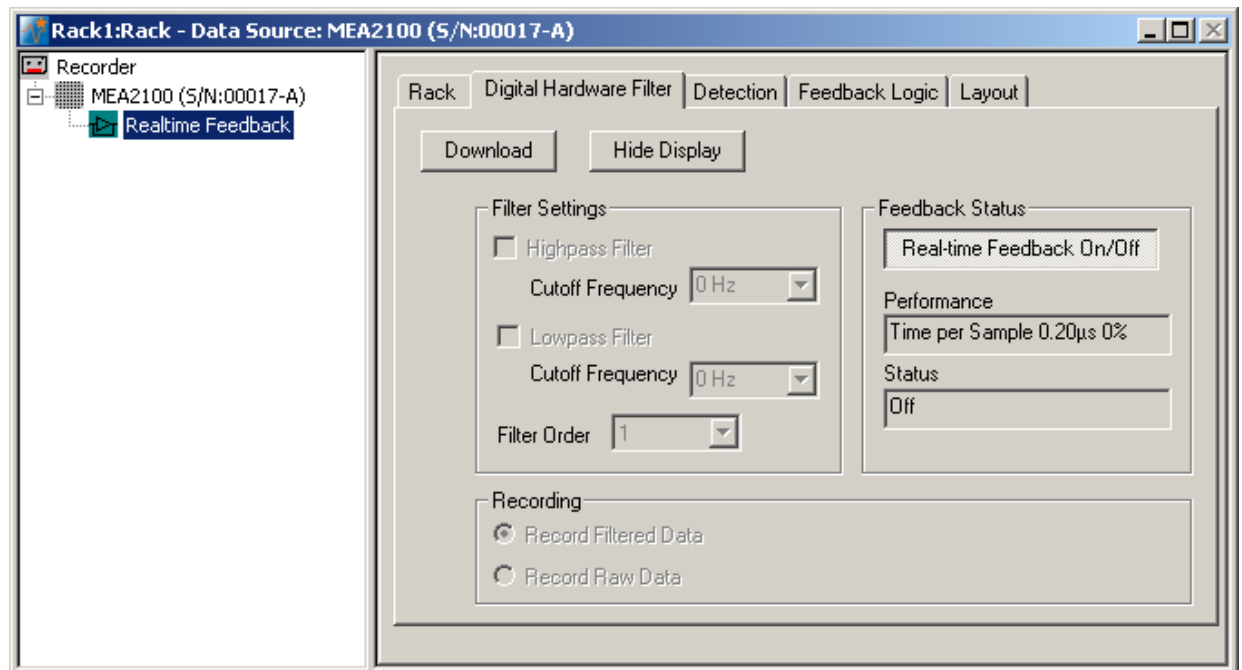

Important: After selecting the filter parameters, you have to download the settings to the DSP with the "Download" command. The "Download" button is available only if a download is necessary. Pressing "Download" in any tab will send the settings from all tabs to the DSP. The settings will also be automatically downloaded when the "Play" button in the main window is activated.

With the "**Feedback**" button you can switch the tool on or off. With the command button "**Hide Display**" it is possible to toggle the real-time feedback display.

Select the data stream you want to record. It is possible to generate feedback on a filtered data stream, but still record the original, unfiltered data. The selected stream "**Record Filtered Data**" or "**Record Raw Data**" will be sent to MC_Rack, and can be used for all other instruments. If you select "Record Raw Data" the data is still filtered by the Digital Signal Processor (DSP) for performing real-time feedback, but unfiltered data is sent to MC_Rack. With this option, it is necessary to use a digital filter in MC_Rack to observe the data filtered in the same way as it is used for real-time feedback processing.

Enable or disable the check box "**High Pass Filter**". Select the high pass "**Cutoff Frequency**" from the drop down menu in a range from 10 Hz to 2 kHz. Other frequencies may be directly edited. 1 Hz is the smallest possible frequency, fractions of the unit are not allowed.

Enable or disable the check box "**Low Pass Filter**". Select the low pass "**Cutoff Frequency**" from the drop down menu in a range from 10 Hz to 2 kHz. Other frequencies may be directly edited. 1 Hz is the smallest possible frequency, fractions of the unit are not allowed. If you apply a high pass and a low pass filter the bandwidth of the resulting band pass filter is defined by the cutoff frequencies of the high- and low pass filter. Select the first, second or third order of the respective filter from the drop down menu. The setting of the filter order applies to all selected filters.

Note: Please use first order filters whenever possible. Higher order filters tend to be unstable and oscillate, especially when using very low or very high cutoff frequencies.



Warning: Please keep an eye on the "Performance" window. The window shows the percentage of time available between two samples that is needed for real-time feedback calculations (filtering and feedback logic). It should never exceed 90 %. Real-time feedback is automatically switched off if more than 90 % of the resources of the Digital Signal Processor (DSP) are expended. In case of performance problems, decrease sampling rate, if possible.

The "Status" window displays the status of the real-time feedback feature: "Off" immediately after disabling the "Real-time Feedback" button, "On" after starting the tool and after the first download.

Signal Detection

In the "Detection" tab, you can define a **threshold as detection level** for each channel separately. All events that cross the threshold are detected. Please read chapter "Spike Detection Methods" under "Spike Sorter" in this manual for more details. As usual, the settings have to be downloaded to the DSP with the "Download" command.

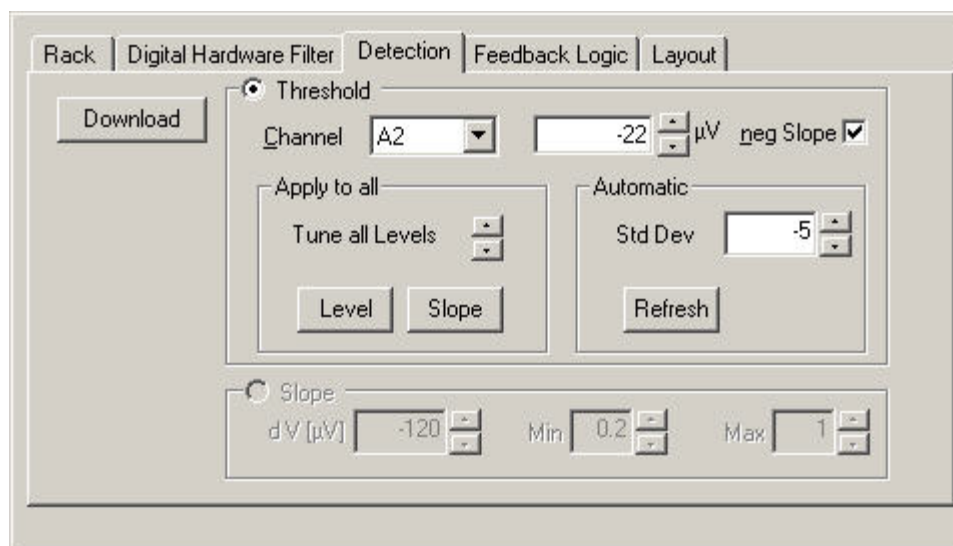

Individual channels can be selected from the drop down menu. For each channel, a threshold in μV can be selected from the numeric updown box. All signals crossing the threshold will be detected as events. The same function can be achieved by dragging the threshold line in the real-time feedback display.

Important: Changes in the detection settings also have to be downloaded to the DSP with the "Download" command.

Enable the check box "neg. Slope". If you select the option "Negative Slope", the fall of the signal curve is regarded, otherwise the rise is considered. This setting applies only to the selected channel. In the "Apply to All" window, click "Slope" button to apply the slope setting to all channels. Click "Level" button to apply the detection level of the currently selected channel to all channels.

To modify the threshold level of all channels, please click the buttons of the "Tune all Levels" numeric updown box. Tuning all channels means, that the different levels of all channels are modified stepwise up or down by the same factor (+1 μV or -1 μV). The current level is displayed in the microvolt box " μV " above.

The "Automatic" feature is convenient to automatically assign an individual detection level to each channel. The standard deviation of the noise of each data trace is used to estimate its signal threshold.

A time interval of 500 ms is used to calculate the standard deviation. You can set the factor by which the standard deviation is multiplied to set the detection threshold numeric updown box. Click "Refresh" button to calculate the standard deviation from the currently recorded data, and to apply the result. It depends on the distribution of noise and spikes, which factor should be used. The higher the spike rate, the lower the factor can be set. The sign of the factor determines whether the spike detection level is positive or negative. A value between -3 and -5 is appropriate for most applications.

The "Slope" window for detecting spikes by their waveform is not available at the moment and will be implemented in future versions of MC_Rack.

Feedback Logic

The "Feedback Logic" of the DSP monitors whether the conditions for generating a feedback defined by the user are met, and triggers a TTL signal in response. The logic operates with **logical states**. The logical state of an electrode, or a combination of electrodes, can be **TRUE** or **FALSE** regarding the condition defined by the user. If necessary, the logical states of more than one electrode are combined (see AND and OR function below). A TTL is generated if the logical states, or the combination of logical states, fulfill the user defined condition.

The conditions that trigger a TTL signal on each of the 16 bits of the Digital Output are defined in the "Feedback Logic" tab. A different condition can be assigned to each bit. Some settings are for all outputs bits, while others can be adjusted for each bit individually.

General Settings: Please choose the number of digital output bits you want to use from the numeric updown box first. For each bit, a separate control unit in the dialog will become available (see below). The display is immediately adapted when the number of digital bits is changed.

The screenshot shows the "Feedback Logic" configuration window. At the top, there are tabs for "Rack", "Digital Hardware Filter", "Detection", "Feedback Logic", and "Layout". The "Feedback Logic" tab is selected. Below the tabs, there are two main sections: "General Settings" and "Individual Settings".

General Settings: This section is highlighted with a red rounded rectangle. It contains a "Download" button, a "Number of Digital Output Bits" updown box set to 2, a "Time Window" updown box set to 500 ms, and an "Event Duration" updown box set to 5 ms. To the right of these settings is the label "General Settings" in red.

Individual Settings: This section is also highlighted with a red rounded rectangle. It features a grid of 16 electrode buttons (12-28) arranged in two columns. To the right of the grid, there is a "Spike Count" dropdown menu set to "Single Spike". Below the grid, there are two sets of radio buttons: "Overall Rate" (unselected) and "Single Rates" (selected), and "AND" (unselected) and "OR" (selected). To the right of these is a "Digital Out" dropdown menu set to "D0". The label "Individual Settings" is in red.

Select a "Time Window" in milliseconds from the numeric updown box. The time window defines the time in which the rates of signals should be counted. For performance reasons, the window is limited to 1000 ms.

Important: The time window is not a fixed time bin, but a **moving window**. For example if the window is set to 1 s, and a rate of 10 Hz is set as condition, the condition is fulfilled as soon as ten events within a second are detected. Therefore, it may not happen that these ten events fall by chance in two separate time bins and are not counted as 10 Hz.

Important: For the purpose of this feature, a "Rate" is defined as the number of events in the selected time window.

MC_Rack Manual

Select the "Event Duration" in milliseconds from the numeric updown box. The event duration is the time after a crossing of the detection threshold that the detection condition is considered as fulfilled. This duration influences the length of the resulting feedback TTL, and is especially important when the input from several electrodes is combined with the "AND" and "OR" function (see below). That means, for the Feedback Logic, the logical state of a channel becomes TRUE from the detection point of an event till the end of the event duration.

Please see image below:

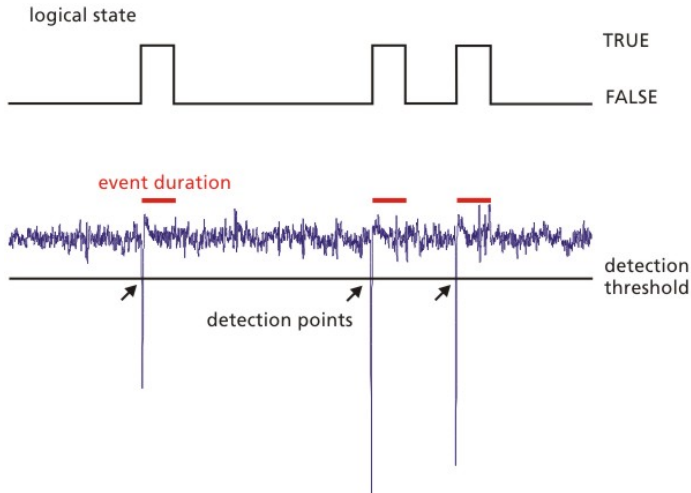

If only one channel is used as input, the duration of the resulting digital TTL pulse is as long as the logical state is TRUE. As usual you have to download all settings to the DSP with the "Download" command.

Individual settings: The following control functions are available for each output bit of the digital channel:

01	02	03	04	05	06	07	08	Spike Count Single Spike	<input checked="" type="radio"/> Overall Rate <input type="radio"/> Single Rates	<input type="radio"/> AND <input checked="" type="radio"/> OR	Digital Out D0
09	10	11	12	13	14	15	16				
17	18	19	20	21	22	23	24				
25	26	27	28	29	30	31	32				

Select the channels you want to detect signals from by clicking onto the **channel block**. The layout on the channel block depends on the settings in the **Data Source Setup**. Selected channels will be highlighted in grey. Deselect a channel by clicking it again. Events from the same electrode can be used in more than one logical block.

Select the bit of the Digital OUT you want the condition to be assigned to. The Digital OUT has 16 bits, D0 to D15.

Time Window
50 ms

Spike Count
Single Spike

- Single Spike
- 2 (40.0Hz)
- 3 (60.0Hz)
- 4 (80.0Hz)

Select from the **"Spike Count"** drop down menu either **"Single Spike"** or values from 2 to 100. This corresponds with the number of spikes that have to be detected in the defined time window to fulfill the criteria to generate a feedback. The frequency resulting from the selected combination of time window and spike count is also shown in the drop down menu in brackets.

If more than one electrode and a spike count larger than one is selected, the selection **Single Rate / Overall Rate** becomes available. **"Single Rate"** means that the spike rate of each selected electrode is counted separately, and that the given spike count has to be reached on any of these electrodes to set the logical state of this channel on TRUE. **"Overall Rate"** means that the spikes of all selected channels are counted together, and that the combined spike count in the selected time window must reach the threshold to generate the logical state TRUE. If more than one electrode and **"Single Spike"**, or **"Single Rates"** is selected, it is necessary to combine the logical states of the different electrodes with the functions **"AND"** or **"OR"**.

If **"AND"** is selected, a feedback is generated only if all electrodes have the logical state TRUE at the same time. If **"OR"** is selected, a TTL is generated if any of the electrodes has the logical state TRUE.

The length of the TTL is determined by the overlap (AND) or addition (OR) of the TRUE states of the individual electrodes.

Please see the following example:

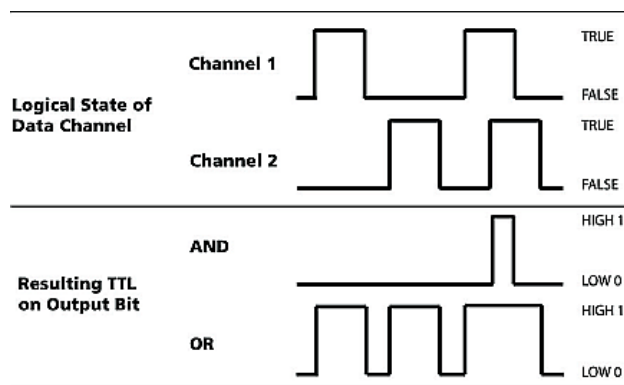

When selecting **"Overall Rate"** or one channel only, the logic option **"And"** or **"Or"** is not applicable.

Rate Detection

Important: For the purpose of this feature, a Rate is defined as the number of events in the selected time window. The time window is not a fixed time bin, but a moving window. For example if the window is set to 1 s, and a rate of 10 Hz is set as condition, the condition is fulfilled as soon as ten events within a second are detected. It may not happen that these ten events fall by chance in two separate time bins and are therefore not counted as 10 Hz.

MC_Rack Manual

In case of **rate detection**, the logical state becomes TRUE from the detection point of the last event that is needed to fulfill the rate condition till the end of the event duration. If the rate of detected events stays above the rate threshold, the logical state will remain TRUE as long as the rate condition is fulfilled. In the example below, a window of 200 ms and a rate of five events per window is set as condition. The logical state becomes TRUE upon detection of the fifth spike within 200 ms, and stays TRUE because the event rate remains above threshold.

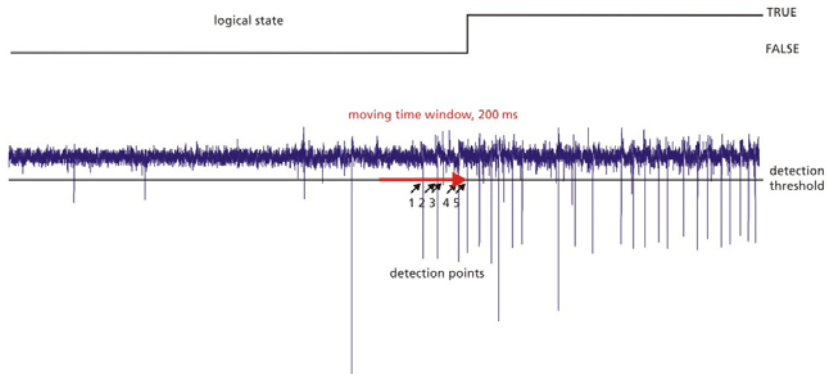

As shown above the status of the TTL output bit will remain HIGH as long as the logical state, or the combination of logical states of all selected electrode channels, fulfils the condition defined by the user, including the AND / OR function.

Note: More complicated operations are possible when using custom software to control the DSP.

Real-time Feedback Display Window

The Real-time Feedback tool automatically opens a display window, which will show the raw data or data filtered by the digital hardware filter of the real-time feedback tool, the spike detection level and the TTL feedback signal. The starting point of the trigger is marked by the small triangle above. The duration of the trigger is indicated. You can change the color of all traces with a right click onto the trace, as usual.

If one electrode is used for more than one logical block, the detected events and resulting TTL pulses for all applicable logical blocks will be indicated in the data window of that electrode. Turn on the "display labels" function with a right mouse click to see which trace belongs to which digital output bit. See red trace for D0 and green trace for D1 in image below.

If two or more electrodes are combined with the condition OR, detected events on any of the combined electrodes will be indicated in each electrode data display. See dashed line in image below: An event is detected on the lower electrode only, but is indicated with a red triangle in both electrodes' displays, as these electrodes are combined with the condition OR.

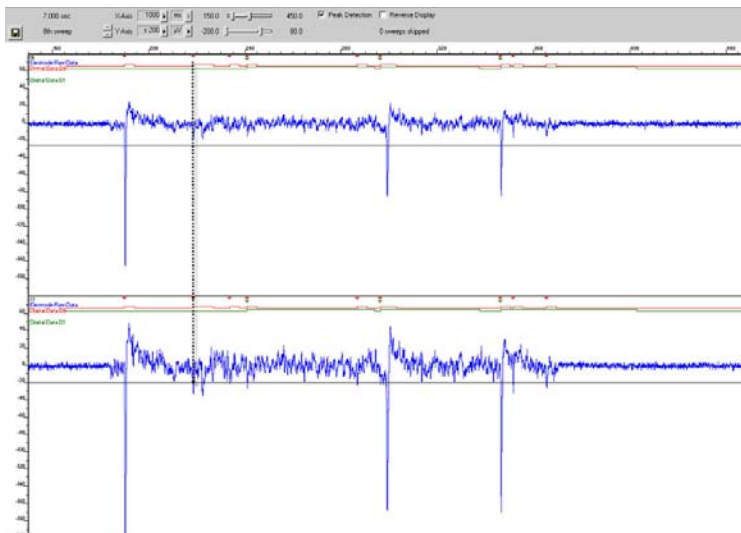

Examples:

The following examples further illustrate the possible combinations of the Feedback Logic. In example one, single spikes are detected on two channels combined with the condition OR. Hence, the logical state of each channel is TRUE from the detection of an event till the end of the event duration (shown in red). As the two channels are combined with OR, a TTL is generated as long as any of the two channels, or both, have the logical state TRUE.

In example two, the same channels are combined with the condition AND. This means, a TTL is generated only if both channels have the logical state TRUE. This setting can be used to detect simultaneous events. By adjusting the event duration, it is possible to define how close together two events have to be to trigger a feedback stimulation.

Important: In extreme cases, if the overlap between the TRUE states of all selected channels is very short (below 20 μ s), the generated TTL might be too short to trigger the stimulus generator.

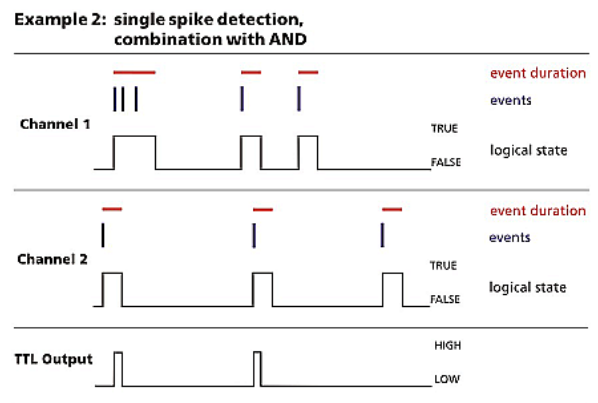
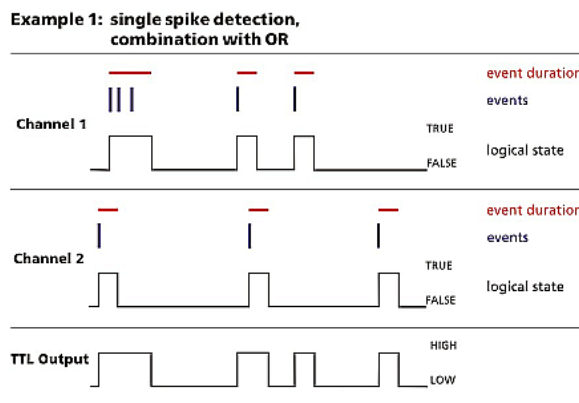

In example three, spike rates are detected with the condition eight spikes per time window. The two channels are combined with the condition OR. The logical state of channel one becomes TRUE upon detection of the eighth event in the time window until the last event that fulfils the condition, plus the event duration. In channels two, the event rate is too low. As both channels are combined with OR, the TRUE state of channel one is sufficient to trigger a TTL output.

In example four, the overall event rate of channel one and two is combined and the condition is again eight events per time window. The addition of both channels results in longer and more TTL outputs. As the activity of both channels is counted together anyway, the combination parameter AND / OR is not applicable.

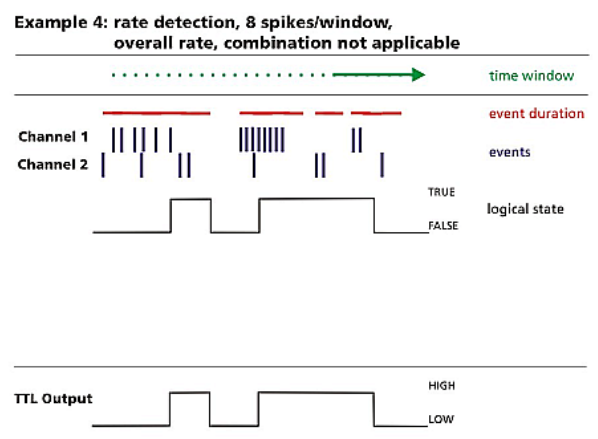
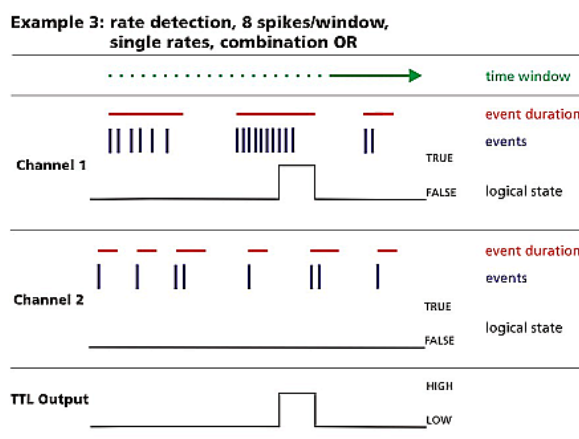

4.12 Filtering Data

4.12.1 Filtering Data

The **Digital Filter** tool can be used online or offline. Displays in dependence of filters can show the unfiltered and filtered data stream at the same time, so it is possible to directly monitor the effect of the filtering on the data. This is especially important because all filters are known to distort signals. Keep in mind that you may need a higher sampling rate to avoid aliasing. Please see also chapter "Filtering and Sampling Rate" for more information about aliasing.

The filter tool creates a separate data stream that will show up in dependent displays and instruments, as well as in the recorder. More than one filter can be used in combination on the same data stream (one filter type after the other). However, this option consumes a lot of system resources and can in some cases lead to performance problems. A range of filter types are available, please see chapter "Filter Characteristics" below for a short description.

Click Edit drop down menu "Add Filter". Select "Filter" tab.

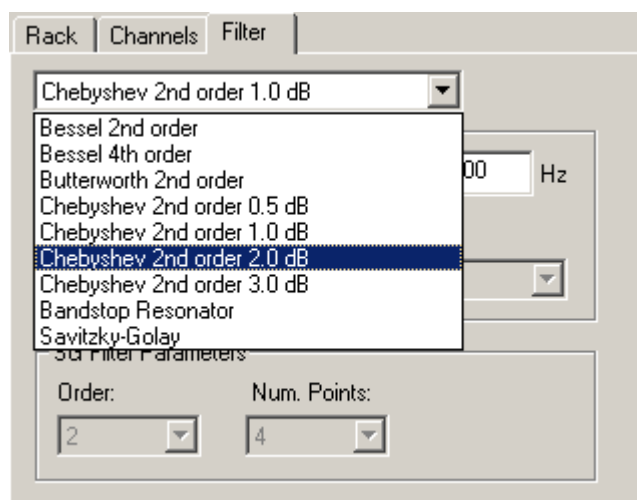

Filter types: Bessel 2nd order

Bessel 4th order

Butterworth 2nd order

Chebyshev 2nd order, 0.5, 1.0, 2.0 and 3.0 dB

Bandstop Resonator

Savitzky Golay

Filters can be used to remove background noise from signals or to separate signal components with different frequencies. The filter creates a separate data stream that can be recorded or further processed. For example, you can use a high pass filter to separate spikes from slow field potentials, and afterwards detect and analyze spikes on the filtered data.

The low pass filter preserves frequencies below passband; frequencies above stop band are removed, with a smooth transition in-between. The high pass filter preserves high frequencies.

Note: All filters distort signals, so use the filter carefully!

Adding a filter to your rack

1. To add a virtual filter to your rack, click "Add Filter" from Edit menu, or click the **Filter** button  on the toolbar.
2. Click the Channels tab and select the channels you like to be filtered.

Click the **Filter** tab to select the filter type. If you choose the **Butterworth** filter you have to define high or low pass and the cutoff frequency. If you select the **Savitzky-Golay filter** you have to define the order and the "Number of Points" used for averaging. The number of points gives the quantity of points, which are included from the right and the left side of a data point for averaging the calculated data point (2, 4, 8, 16, 32, 48).

Note: If you choose a high number of data points for averaging, for example 32 or 48, the computer needs a high performance for calculating each filtered data point!

The cutoff frequency for spikes (**High Pass**) is typically in the range of 0.3 to 3.5 kHz; for LFPs (**Low Pass**) 10 to 500 Hz is suitable. The cutoff frequency of the filter must be compatible with the frequencies present in the signal of interest.

Changing the lowest and highest bandpass frequency

Use **two filters** for changing the lowest and highest frequency of the pass band. For example, if you use a broadband amplifier and you need a bandwidth of 300 Hz to 3 kHz for recording spikes, combine a high pass filter with a cutoff frequency of 300 Hz and a low pass filter with a cutoff frequency of 3000 Hz. Select the "Filtered Data" output stream of the first filter as the input stream for the second filter.

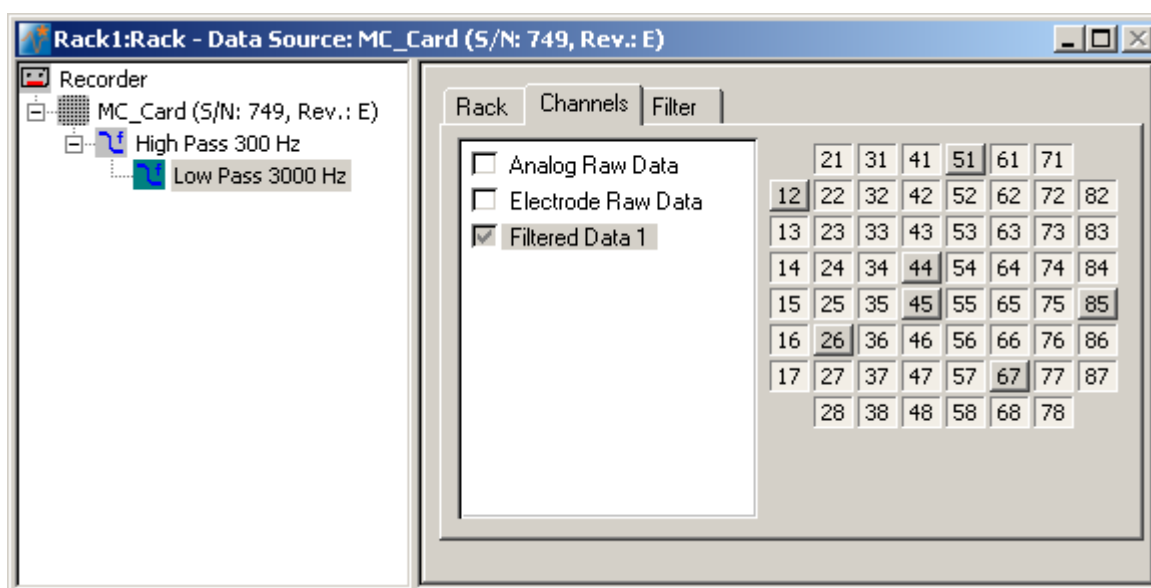

Signal distortion

Though filters present an easy and convenient way to remove unwanted signals from your data, filters should be used with care. All filters (analog and digital) distort signals, especially if the signal frequencies lie near the cutoff frequency. You should be aware of the fact that the signal amplitude may be modified by a filter, and that the signal may be shifted as well.

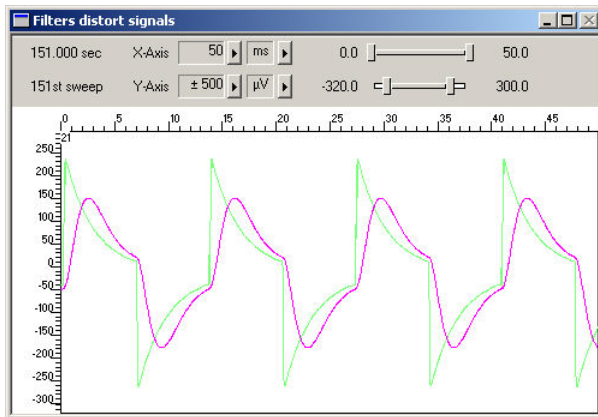

In this screen shot, you see regular signals (from a signal generator) with a frequency of about 70 Hz (green traces). The cutoff frequency of the low pass filter has been set to 200 Hz. A low pass filter removes high frequency components of signals. You can clearly see that the amplitude of the filtered data (magenta) is decreased and the phase of the signal has been shifted slightly.

The distortion increases with increasing signal frequency. If the frequency is set near the cutoff frequency, the shape of the signal has changed to a sinus waveform.

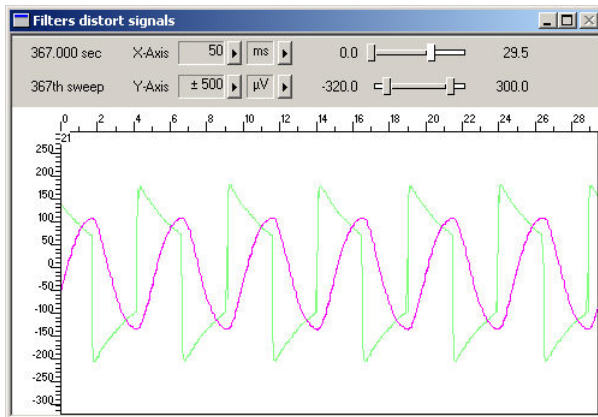

If the frequency is increased far beyond the cutoff frequency, for example 1 kHz, the signals are almost completely removed (which is, of course, the purpose of a filter).

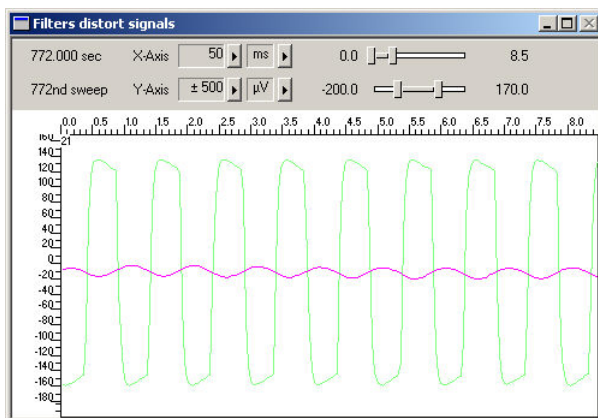

4.12.2 Filter Characteristics

Bessel

A Bessel filter is a type of linear filter with a maximally flat group delay (maximally linear phase response). Analog Bessel filters are characterized by almost constant group delay across the entire passband, thus preserving the wave shape of filtered signals in the passband.

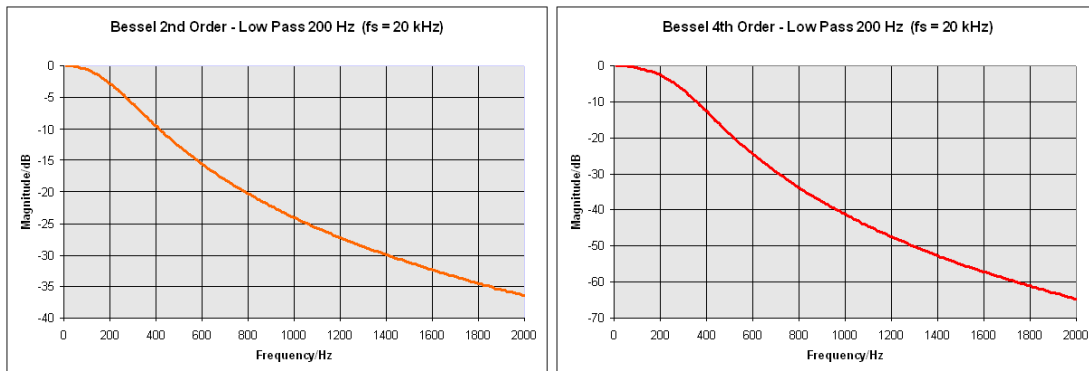

Butterworth

The Butterworth filter is designed to have a frequency response which is as flat as mathematically possible in the passband.

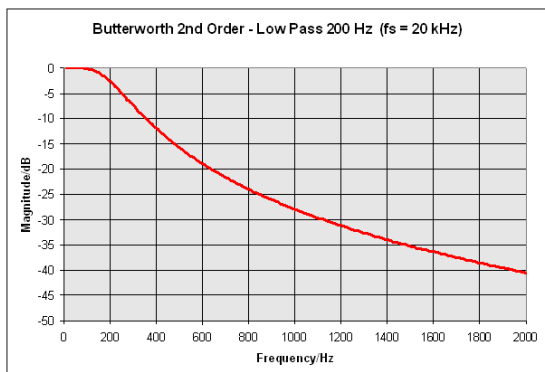

Chebyshev

Chebyshev filters are analog or digital filters having a steeper roll-off than Butterworth filters. Chebyshev filters have the property that they minimize the error between the idealized filter characteristic and the actual over the range of the filter, but with ripples in the passband. Because of the passband ripple inherent in Chebyshev filters, filters which have a smoother response in the passband but a more irregular response in the stopband are preferred for some applications.

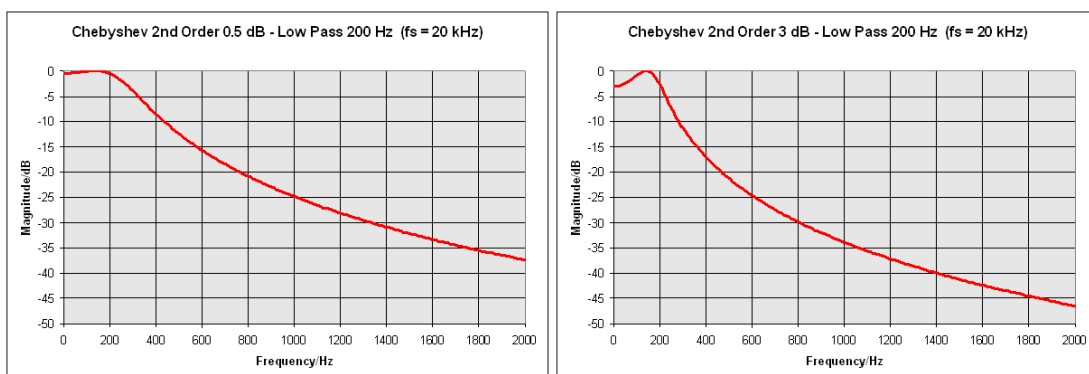

Bandstop Resonator

In signal processing, a bandstop filter is a filter that passes most frequencies unaltered, but attenuates those in a specific range to very low levels. A bandstop filter with a high Q factor has a narrow stopband. Please see the following pictures.

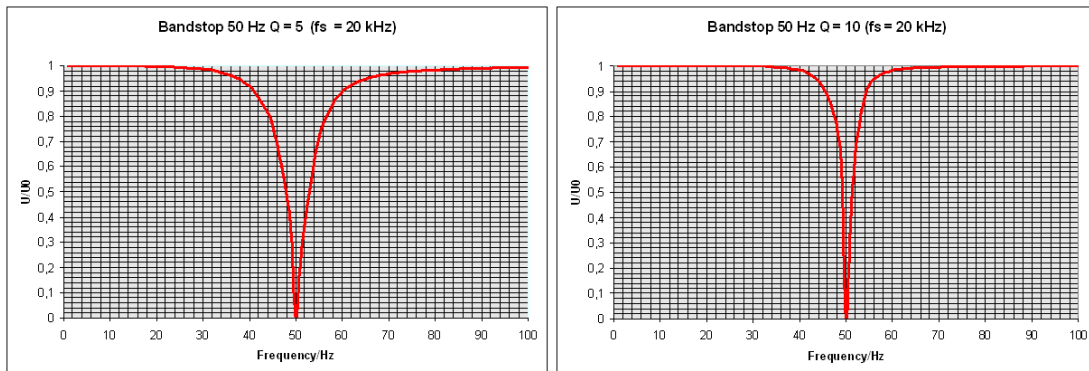

Savitzky Golay

The parameters of the Savitzky-Golay filter are the order (2 or 4) and the number of points which are included from the right and the left side of a data point for averaging the calculated data point (2, 4, 8, 16, 32, 48). This filter can be used to smooth a noisy signal. However, it is possible to accidentally filter out fast signals, like spikes.

The y-axis is the normalized amplitude, that is, the output amplitude divided by the input amplitude. The x-axis represents the frequency of a sinus-wave function. The red line indicates the input signal amplitude, the purple line indicates the theoretical value at the cutoff frequency, and the green vertical line indicates the cutoff frequency. The data was obtained using a sine wave generator and MC_Rack for the measurement. The cutoff frequency was set to 100 Hz.

All filters except of Savitzky Golay are calculated with the help of Fdlib 0.9.10 Copyright 2002-2004 Jim Peters <http://uazu.net>. This library is released under the GNU Lesser General Public License (LGPL) version 2.1 as published by the Free Software Foundation.

4.12.3 Filtering and Sampling Rate

A sampling rate of at least five times the highest frequency of the signal of interest is generally enough for a reasonable representation of the signals. If you are using a broadband MEA1060 amplifier and a digital low pass filter for removing high frequency noise, however, a higher sampling rate might be necessary.

According to the Nyquist-Shannon sampling theorem, the sampling rate should equal twice the bandwidth of the analog (hardware) low pass filter. The 1/2 bandwidth frequency is also called Nyquist frequency. You may ignore this if saving hard disk space is more important for your application than the noise level.

This is the case because the full amplifier bandwidth is recorded and then high frequency noise is removed with a digital low pass filter after recording. Frequencies (noise) that are above half the sampling rate (for example above 2.5 kHz at a 5 kHz sampling rate) will be transformed into lower frequencies. This is called **aliasing**. This low frequency noise passes the digital low pass filter and increases your noise level.

The other possibility to prevent aliasing is to use a MEA1060 amplifier with an appropriate analog low pass (so-called anti-aliasing) filter instead of the digital filter instrument.

Example:

This can be demonstrated by the following experiment. A regular 1000 Hz signal (from a pulse generator) is applied to electrode input channels of the MC_Card. In this experiment, this signal represents the high frequency noise that should be removed. A 100 Hz Low Pass filter is used to remove this high frequency "noise" signal.

At a sampling rate of 5 kHz, signals up to 2.5 kHz are safe from aliasing, resulting in a good sampling and filtering result. The screen shot shows the raw data (blue trace) and filtered data (magenta).

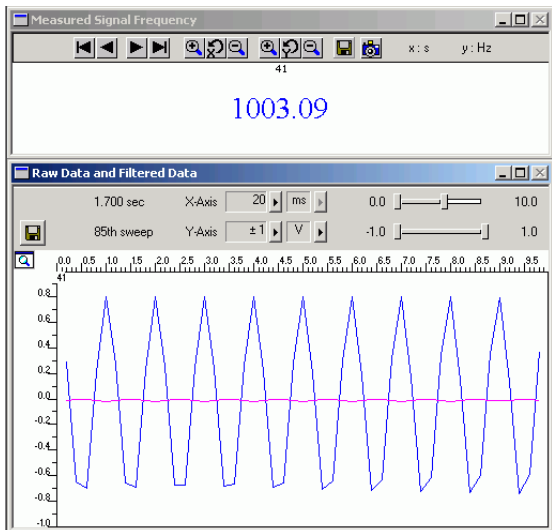

The high frequency "noise" signal has been removed by the filter. The signal frequency of the digitized data (measured with a **Spike Detector** and **Analyzer**) matches the frequency of the analog input signal.

At a sampling rate of 1 kHz, aliasing occurs to frequencies above 1/2 sampling rate, that is, above 500 Hz. Thus, the 1000 Hz signal is digitized to a low frequency signal of about 4 Hz (see time scale of display). Please note that the only difference between the two screen shots is the altered sampling rate. The input signal is exactly the same.

Of course, the low frequency noise signal passes the digital low pass filter. The raw data and the filtered data traces match perfectly.

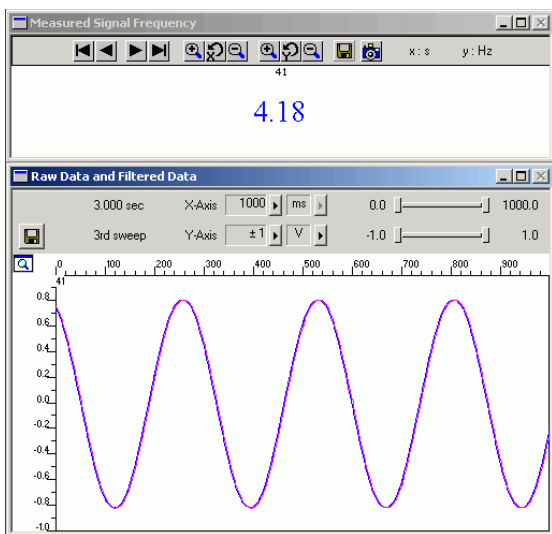

4.12.4 Downsampling

The MC_Rack downsampling feature offers the possibility to generate raw and filtered **data streams with different sampling frequencies**. This can help to avoid huge amounts of resulting data when recording more than one data stream. For example, you can record spikes with a high sampling rate, and a second filtered data stream with slow field potentials with a lower sampling rate (please see the example at the end of the section).

The maximum sampling frequency used in a file is still defined in the Data Source. To add an additional data stream with a lower sampling rate, you need to use a **digital filter** tool. The parameters for the downsampled data stream are set in the filter tool dialog, as using a low pass filter is a precondition for the downsampling feature.

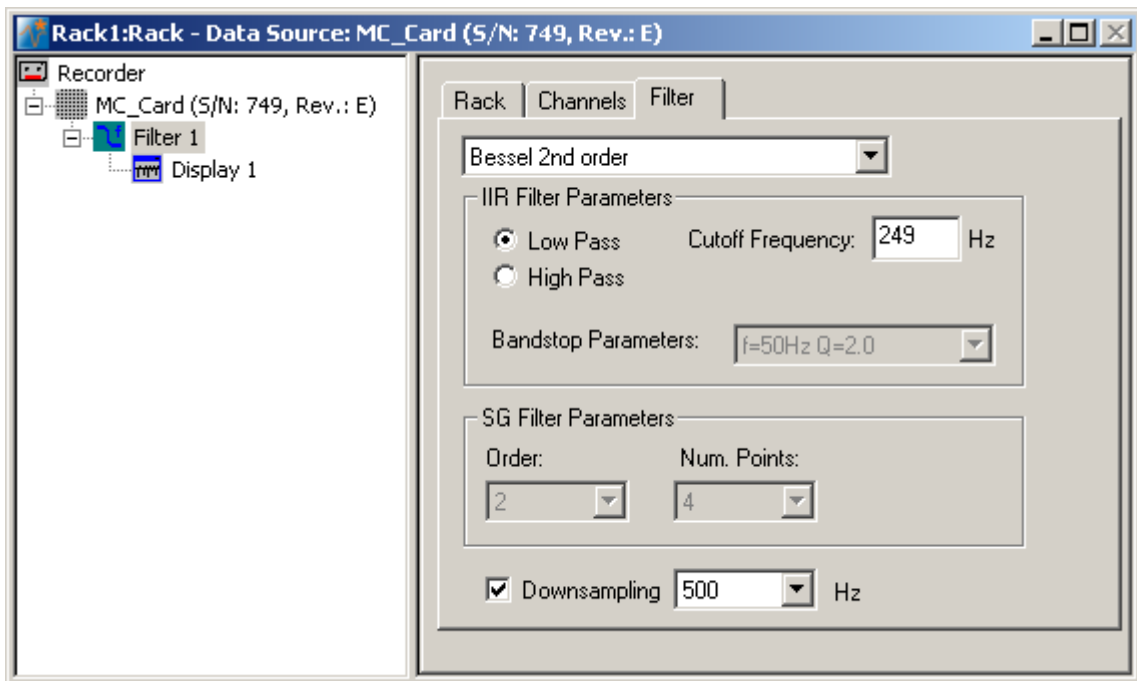

Click Edit menu **"Add Filter"** or click the filter icon in the main menu toolbar.

Note: All filters distort signals, so handle filters with care!

Click the **"Channels"** tab and select the data stream and the channels you want to apply the downsampling to. Open the **"Filter"** tab and select an appropriate filter type. Bandstop Resonator and Savitzky Golay filter are not compatible with downsampling, as they do not define a lower cutoff frequency. Select a **"Low Pass"** filter with an appropriate **"Cutoff Frequency"**.

Select the **"Downsampling"** check box and choose a "downsampling frequency" in Hz from the drop down menu. The lowest frequency for downsampling is 100 Hz.

For downsampling electrode raw data you need a proper combination of cutoff frequency and downsampling frequency to avoid aliasing. Please read also chapter "Filtering and Sampling Rate". According to the Nyquist-Shannon sampling theorem, the cutoff frequency of the low pass filter must be half of the downsampling frequency, or less (sampling frequency 2x cutoff frequency, respectively). If the frequencies selected by the user do not match, MC_Rack will suggest an appropriate cutoff frequency for the selected downsampling frequency via the following dialog:

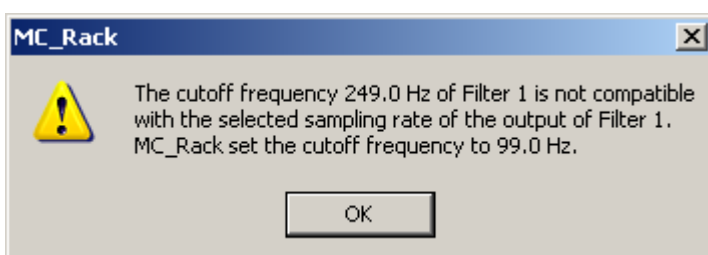

MC_Rack sets the cutoff frequency of the filter automatically. A second dialog will appear and prompt the user to select a cutoff frequency in the possible range (0.1 to half of the downsampling frequency in Hz). Please type in a number in the denoted range.

Note: The second dialog is generated directly by Windows, and will therefore appear in the language set in the operating system.

The filtered and downsampled data will appear as an individual data stream in the "Channels" tab of the Recorder. To record the downsampled data, you have to select this data stream.

Example: Recording two data streams with high frequency spikes and low frequency ERGs from a retina slice with different sampling rates. The following rack contains two filters, a high and a low pass. The data are ERGs from a retina slice with spikes on top of the slow field potentials.

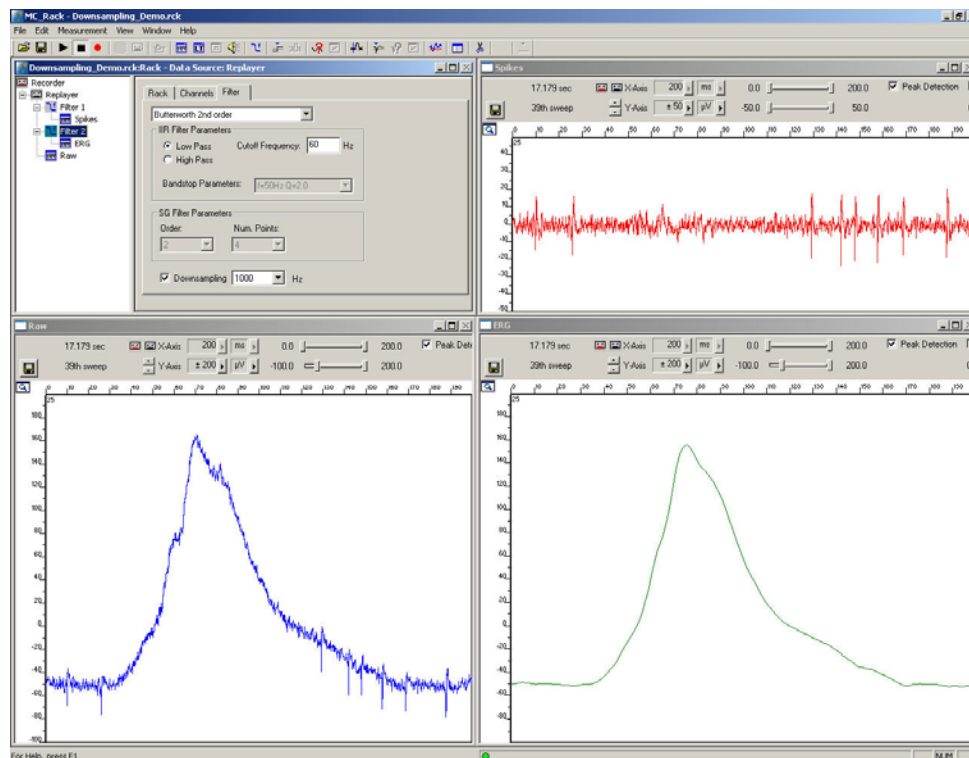

The raw data is shown in blue. The **high pass filter** (Filter 1) subtracts the slow component of the signal, and leaves only the spikes (red). This data stream will be sampled with the frequency set in the Data Source. The **low pass filter** (Filter 2) leaves only the slow component (ERG, green). In this example, the slow field potential gets downsampled to 1000 Hz. Hence, the data stream "**Filtered Data 2**" available in the "Channels" tab of the Recorder is recorded with a sampling rate of 1000 Hz.

Replaying Files with downsampled Data Streams

Files containing data streams with different sampling rates can be replayed by the **Replayer** as usual. In the tab "**Buffer Info**" of the Replayer, you can review the information about the different data streams, including which filters and downsampling options were selected when the file was recorded.

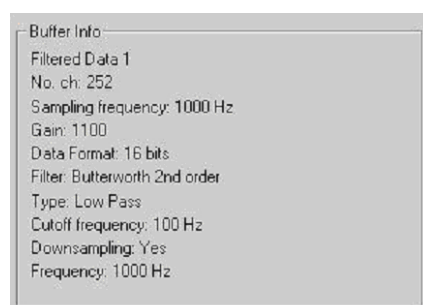

4.13 Spike Sorter

4.13.1 Spike Detection Methods

The virtual **Spike Sorter** instrument is used for **extracting spikes** from the raw data, and for **sorting spikes** into up to **three single units** per electrode (channel).

There are two ways of detecting and extracting spikes with MC_Rack. One method uses a **threshold**, the other recognizes the shape that is, the **amplitude** and **slope** of a curve. Both methods regard either the **rise** or the **fall** of a curve, depending on your settings. Waveforms that meet the requirements defined by either of the two methods are cut out from the raw data. The size of the cutout, that is, the time length before and after the spike detection event, can be chosen by the user. It is also possible to extract only the **time stamps**.

The **Threshold** method is especially useful if the overall signal is steady and the spikes appear approximately on the same height. If you have local field potentials or a high noise level, you will miss spikes or detect noise signals with the **Threshold** method. In this case, the **Slope** method is more appropriate.

The following illustrations show how the two methods work.

Spike detection

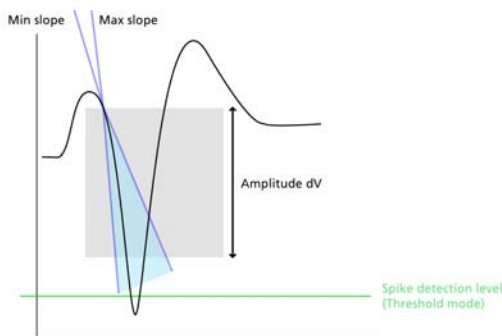

Not detected waveforms

Slope too high

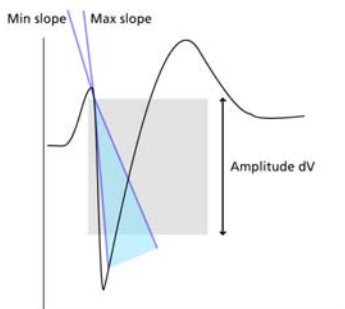

Slope too low

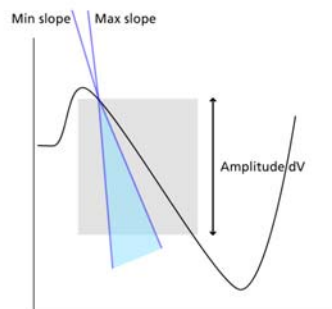

Amplitude too small

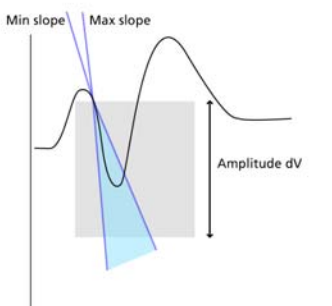

Voltage threshold not reached

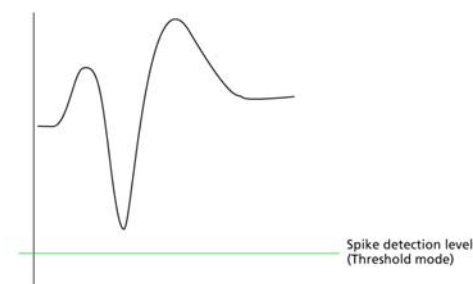

4.13.2 Detecting Spikes by a Threshold

You can define a threshold (spike detection level) for each channel separately. All peaks that cross the threshold are detected. Spike traces are cut out around the detection event. The resulting spike cutouts form a new data stream that can be further processed by other tools, that is, sorted, analyzed, displayed, and so on. See also the preceding illustrations "Spike detection" and "Voltage threshold not reached".

- If you select the option **Negative Slope**, the fall of the curve is regarded, otherwise the rise is considered. This setting applies only to the selected channel. Under **Apply to All**, click **Slope** to apply the slope setting to all channels.

There are several ways to set the detection levels. It is up to your choice which way you like to use.

- Select a channel from the drop-down list and define the threshold for this particular channel.
- You can change spike detection levels by moving them with your mouse in the display window. The values in the rack window will then change automatically.
- You can then **tune all channels**, which means, that the different levels of all channels are modified by the same factor (+ 1 μV or -1 μV).
- You can also apply the same detection level or the negative/positive slope to **all** channels. Under **Apply to All**, click **Level** or **Slope**, respectively.
- The **Automatic** feature is very convenient to automatically assign an **individual** detection level to **each** channel. The standard deviation of each data trace is used to estimate its spike threshold. A time interval of 500 ms is used to calculate the standard deviation. You set the factor, by which the standard deviation is multiplied. Click **Refresh** to calculate the standard deviation and apply the result. It depends on the distribution of noise and spikes, which factor you should use. The higher the spike rate, the lower the factor can be set. The sign of the factor determines whether the spike detection level is positive or negative. You generally will use a negative factor. A value between -1 and -4 is appropriate for most applications.

Spike detection - threshold method

The detection level and the slope apply to the selected channel, channel 01 in this case.

Click the up and down buttons to modify the detection levels of all channels in 1 μV -steps.

Click **Level** to apply the detection level of the currently selected channel to all channels.

Likewise, click **Slope** to apply the slope settings (positive or negative) to all channels.

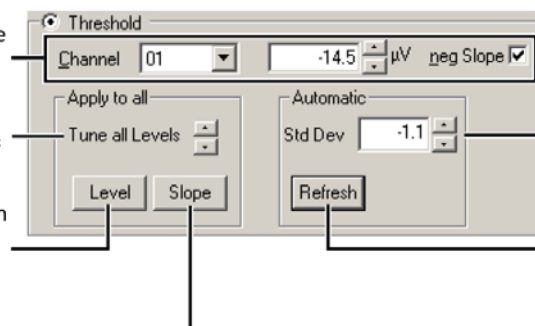

The standard deviation of each data trace is used to estimate its spike threshold. Enter the factor, by which the standard deviation is multiplied.

Click **Refresh** to calculate the standard deviation for each channel and apply the result.

4.13.3 Detecting Spikes by Waveform

With this method, the **shape** of a signal is considered instead of the absolute height of a peak. You define the minimum **amplitude** (in μV), and the **minimum** and **maximum slope** (in $\mu\text{V}/\mu\text{s}$) that a signal must have to be considered as a spike. In contrast to the spike detection level, which presents a fixed absolute voltage level, the **Slope** method searches the incoming data trace **continuously** for a waveform that satisfies the following criteria: The slope range that is specified by the **minimum** and **maximum slope** and the minimum **amplitude (dV)**. The preceding illustration "Spike detection" shows both methods of spike detection (for a negative slope).

The amplitude parameter ensures that noise waveforms that satisfy the slope criteria, but has a too small peak, are not detected (see illustration "Amplitude too small"). On the other hand, there may be voltage drops that are high enough, but too slow or too fast, that is, the slope is too low or too high, respectively. These are not detected, too (see illustrations "Slope too low" and "Slope too high").

Only waveforms that satisfy **both** criteria (slope and amplitude) are considered spikes. See also the preceding illustrations "Spike detection" and "Not detected waveforms".

Spike detection - slope method

Minimum amplitude a signal must have to be considered a spike.

Minimum slope ($\mu\text{V}/\mu\text{s}$)



Maximum slope ($\mu\text{V}/\mu\text{s}$)

4.13.4 Spike Cutouts

You can define the size of the spike cutout in the ranges of **100 ms Pre-Trigger** and **1500 ms Post-Trigger** times. The detection event is the point of time when the threshold has been crossed (threshold method), or the point of time, for which the amplitude and slope criteria have been fulfilled (slope method).

The data from pre-trigger to post-trigger event is the spike cutout. The **Dead Time** determines, for how long after a detection event no new detection event is accepted. You can define **overlapping** cutouts, that is, the **Dead Time** can be set lower than the **Post-Trigger** time. This makes sense for monitoring cardiac arrhythmia, for example. But please note that this affects the computer load. It is recommended to set the **Dead Time** to at least the **Post-Trigger** time for saving computer performance.

The spike cutouts form a new data stream, the **Spike** stream, which can be sorted, analyzed, displayed, recorded, and so on.

Spike cutout - slope method

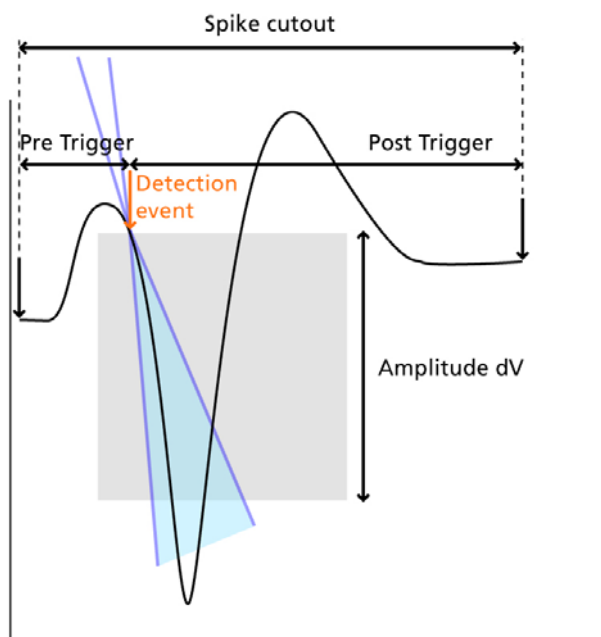

Extracting timestamps only

If you are interested in the spike rate or spatial distribution of spikes but not in the waveform information, you can extract only the detection events of spikes as single data points. This saves computer performance and hard disk space. Please see chapter "Extracting Timestamps only" in "Burst Analysis".

4.13.5 Spike Sorting

Most often, spikes do not represent a single unit activity, but are derived from multiple neurons. Spikes from separate neurons usually have different shapes and a different rhythm. To interpret an experiment, it is often very important to sort spikes into categories, thus separating single unit spikes.

In MC_Rack, you can sort spikes into three groups. The sorted spikes can then be displayed by a **Data Display**.



A special overlay display for spike sorting is provided. You can set the number of spike cutouts that will be overlaid (up to 500) and define the number of groups (up to three). Use the buttons on the display header to switch from the standard **Spike Sorter** display to the **Spike Sorter overlay** display and vice versa. The icon of the active display mode is highlighted in white.

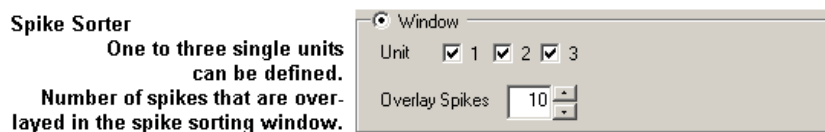

Spike Sorter

One to three single units
can be defined.

Number of spikes that are overlaid
in the spike sorting window.

You simply tag spikes by positioning the red bar with the mouse in the **Spike Sorter overlay** window. You can adjust the height of the bar by dragging it with the mouse. The tag defines a voltage range and a point of time (in relation to the spike cutout). All spikes that fulfill both requirements, that is, lie in the specified range at the specified point of time, are tagged and assigned to the corresponding group. Thus, spikes that have a different shape can be separated from each other. The bars should be moved to the positions, where the two signals differ most from each other to obtain best results.

The spike detection level is very important for spike sorting. If your detection level is too low and you see too many signals and too much noise, it may be difficult to detect and separate single unit activities.



You may like to switch back to the standard **Spike Sorter** display to adjust the spike detection parameters. Click the appropriate button to switch back to the spike detection view.

Also, the number of spikes you overlay is important. If you overlay not enough spikes, you will not see different units. If you overlay too much spikes, the display may be crowded and it may be difficult to distinguish different signals, either. Try different parameters until you get a feeling for the settings.

MC_Rack Manual

The following illustration shows the activity of two neurons, as spike cutouts on a small time basis. The first (red) signal has one peak, the second (yellow) spike waveform shows a small peak followed by a bigger peak. The window bars are positioned at the time point where both signals differ most. 100 spikes are overlaid in this plot.

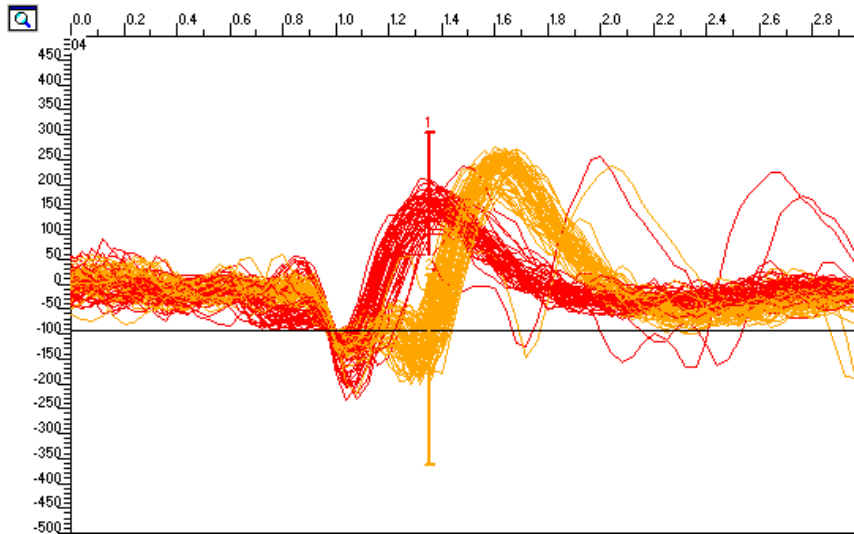

When zooming into a channel in Spike Sorter overlay mode (as shown above) be aware that the traces might be displayed in low quality, that means, you can discriminate single pixels. The quality of the picture increases when the display is refreshed.

The next illustration shows the sorted spikes (Raw Data). The blue signals do not belong to either of the two units.

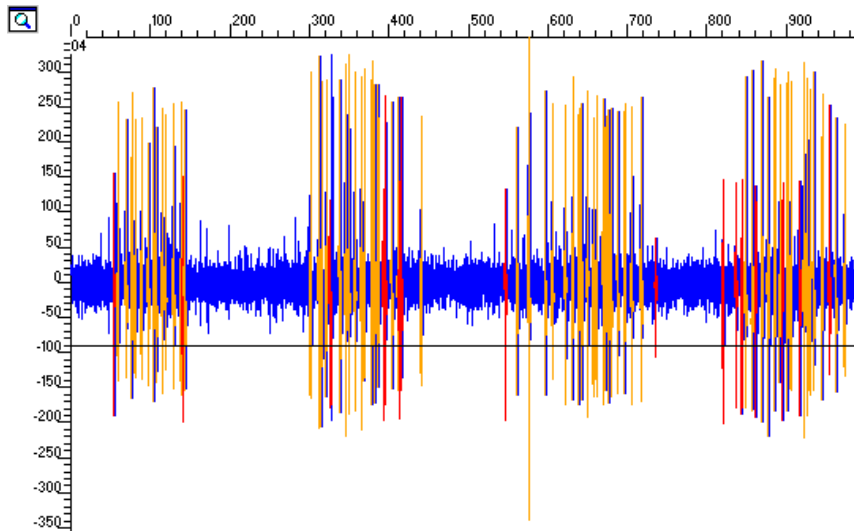

4.13.6 Burst Analysis

The "**Burst Detection**" option allows the detection and analysis of spike bursts. The spikes have to be detected by the spike sorter first. The quality of the burst analysis therefore depends heavily on the accuracy of the spike detection.

Add the "**Spike Sorter**" and the "**Spike Analyzer**" to the virtual rack. Click "**Analyzer**" tab. Spike burst analysis will be active as soon as the "**Burst Marker**" is selected. Bursts are detected based on the **MaxInterval** Method. The method is explained below.

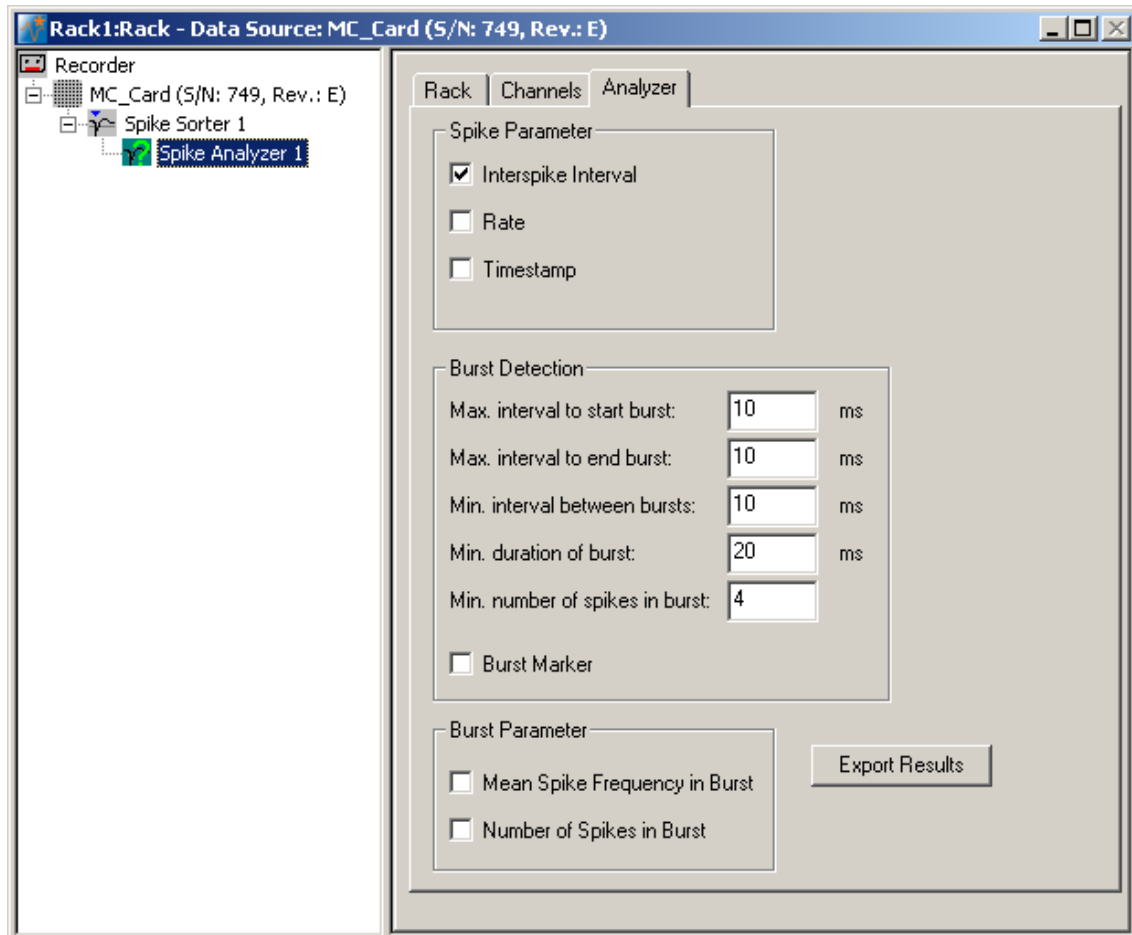

The MaxInterval Method for detecting bursts

Find all bursts using the following **algorithm**:

- Scan the spike train until an interspike interval is found that is less than or equal to **Max. Interval**.
- While the interspike intervals are less than **Max. End Interval**, they are included in the burst.
- If the interspike interval is more than **Max. End Interval**, the burst ends.
- Merge all the bursts that are less than **Min. Interval between Bursts** apart.
- Remove the bursts that have duration less than **Min. Duration of Burst** or have fewer spikes than **Min. Number of Spikes**.

The **detection parameter** for bursts are shown in the following picture.

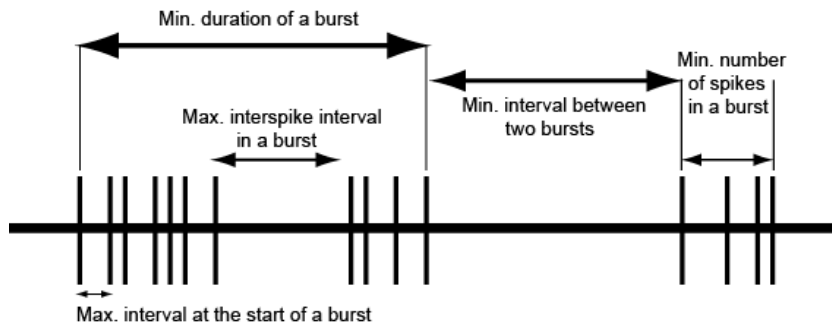

Parameter for burst detection:

Max. interval to start bursts: maximum interspike interval to start the burst.

Max. interval to end a burst: maximum interspike interval to end the burst.

Min. interval between bursts: minimum interspike interval between two bursts.

Min. duration of burst: minimum burst duration.

Min. number of spikes in burst: minimum number of spikes in a burst.

(Reference: Legendy C.R. and Salzman M. (1985): Bursts and recurrences of bursts in the spike trains of spontaneously active striate cortex neurons. *J. Neurophysiology*, 53(4) : 926-939).

Monitoring of Spike Burst Detection

To monitor the spike burst detection, it is possible to display the detected spikes as **Timestamps** in a spike parameter window. If the "**Burst Marker**" is selected, a line under the timestamps will mark the detected bursts. The image below shows a spike burst and the corresponding timestamps in a spike parameter window, with the green line below depicting the detected burst.

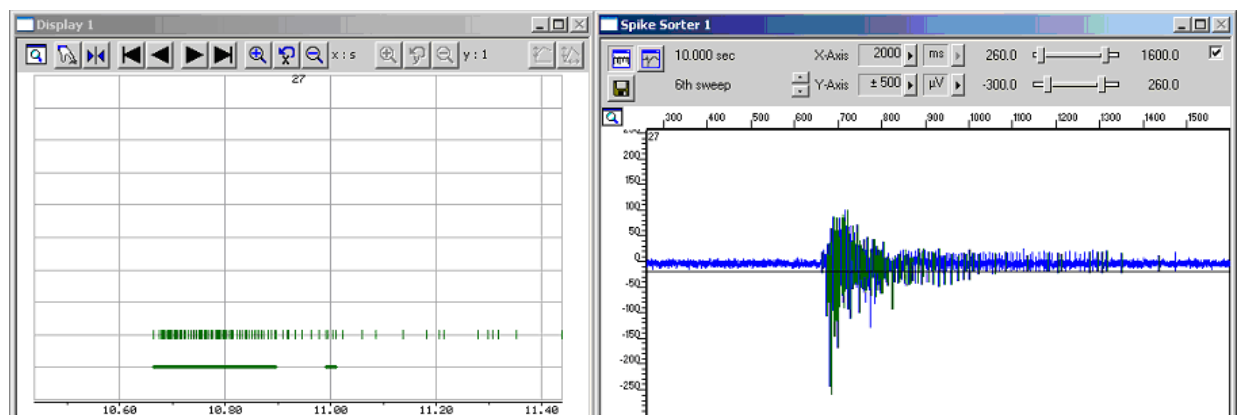

Different units on each electrode, separated by the spike sorter, will be shown in different colors. In the same window, a color coded line under the time stamps will mark the detected bursts individually for each unit. Unit 0 represents all unsorted spikes together, and is displayed in green as shown in the picture above.

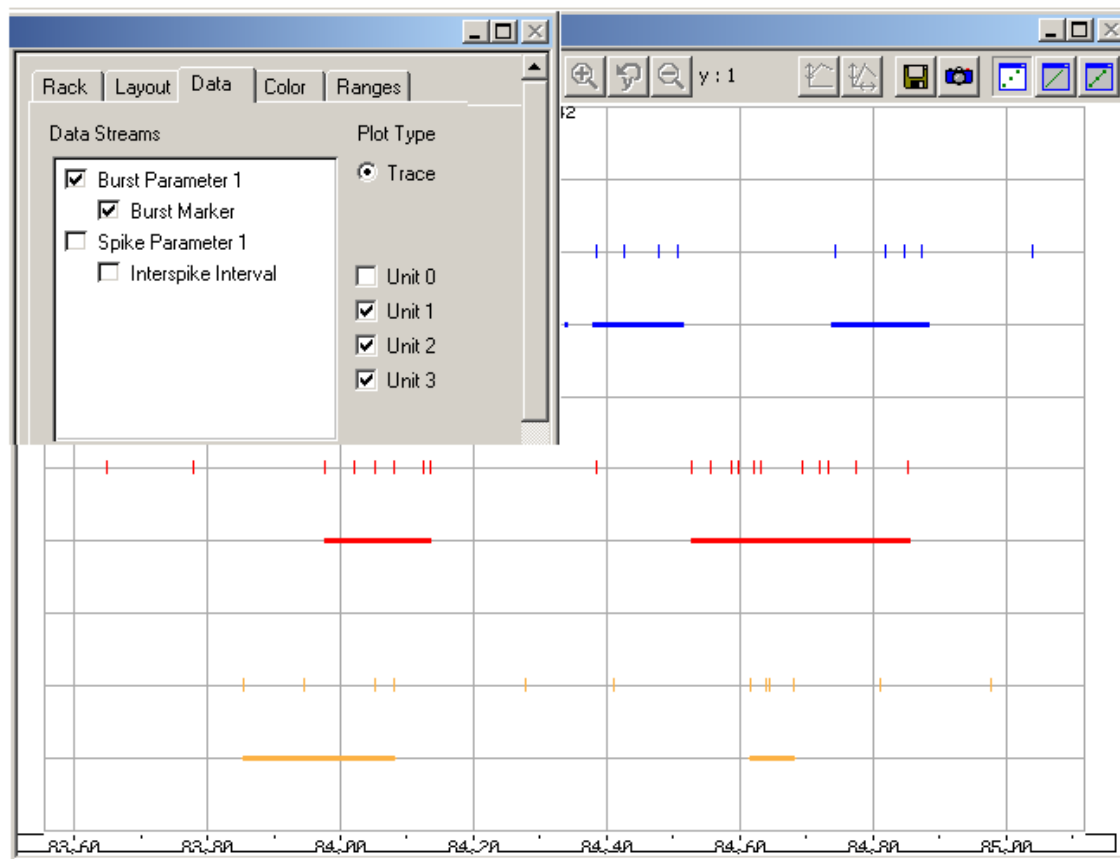

Online Detection of Spike Burst Parameters

Click in "**Spike Analyzer**" the "**Analyzer**" tab. The "**Burst Detection**" dialog allows setting the parameters described above. Additionally, the user can select which spike and burst parameters should be analyzed. The parameters selected in the menu are analyzed online for each detected burst.

Burst parameters are **Mean Spike Frequency** (mean spike frequency inside burst plotted for each burst), and **Spike Number** (number of spikes inside burst plotted for each burst).

These parameters can be plotted versus time in a spike parameter display, just like the overall spike frequency or the ISI. One parameter display can show either the mean spike frequency or the spike number per burst. These results can be exported as picture or ASCII with the standard export function of parameter displays.

Analysis of Spike Burst Parameters

In addition to the two parameters mentioned above, the burst parameters listed below are calculated for the whole detection period that means from start to stop of data acquisition. Analysis is done whether the data is recorded or not. With the command "**Export Results**" you can export the numerical results of the spike burst analysis to a tab delimited (text without formatting) file with the extension *.dat. The file includes the listed analysis parameters of spikes and bursts, organized in columns:

MC_Rack Manual

1. Channel / Unit
2. Number of Spikes
3. Mean Spike Frequency [Hz]
4. Number of Bursts
5. Bursts per Second
6. Bursts per Minute
7. % of Spikes in Burst
8. Mean Burst Duration [ms]
9. Mean Spikes in Burst
10. Mean ISI in Burst [ms]
11. Mean Spike Frequency in Burst [Hz]
12. Mean Interburst Interval [ms]

	A	B	C	D	E	F	G	H	I	J	K	L
1	Numerical Results of Spike/Burst Analysis:											
2												
3	Channel/Unit	Num. Of Spikes	Mean Spike Frequency [Hz]	Num. Bursts	Bursts per Second	Bursts per Minute	% of Spikes in Burst	Mean Burst Duration [ms]	Mean Spikes in Burst	Mean ISI in Burst [ms]	Mean Spike Frequency in Burst [Hz]	Mean Interburst Interval [ms]
4	47_unit0	66	2.619048	2	0.079365	4.761905	100	147.75	33	4.617188	216.582064	11832.15
5	48_unit0	0	0	0	0	0	---	---	---	---	---	0
6	46_unit0	2	0.079365	0	0	0	0	---	---	0	---	0
7	45_unit0	0	0	0	0	0	---	---	---	---	---	0
8	38_unit0	24	0.952381	0	0	0	0	---	---	0	---	0

Hint: All parameters will be calculated, independently from the selected online burst parameters.

Extracting Timestamps only

If you are interested in the spike rate or spatial distribution of spikes but not in the waveform information, you can extract only the detection events of spikes as single data points. This saves computer performance and hard disk space.

Add the "Spike Sorter" and the "Spike Analyzer" to the virtual rack. Click "Analyzer" tab. Select the check box "Timestamp".

Spike Parameter

Interspike Interval

Rate

Timestamp

Add a display to your virtual rack. Click "Data" tab. In "Data Streams" select "Spike parameter 1" and "Timestamp". In "Plot Type" please select check box "Trace".

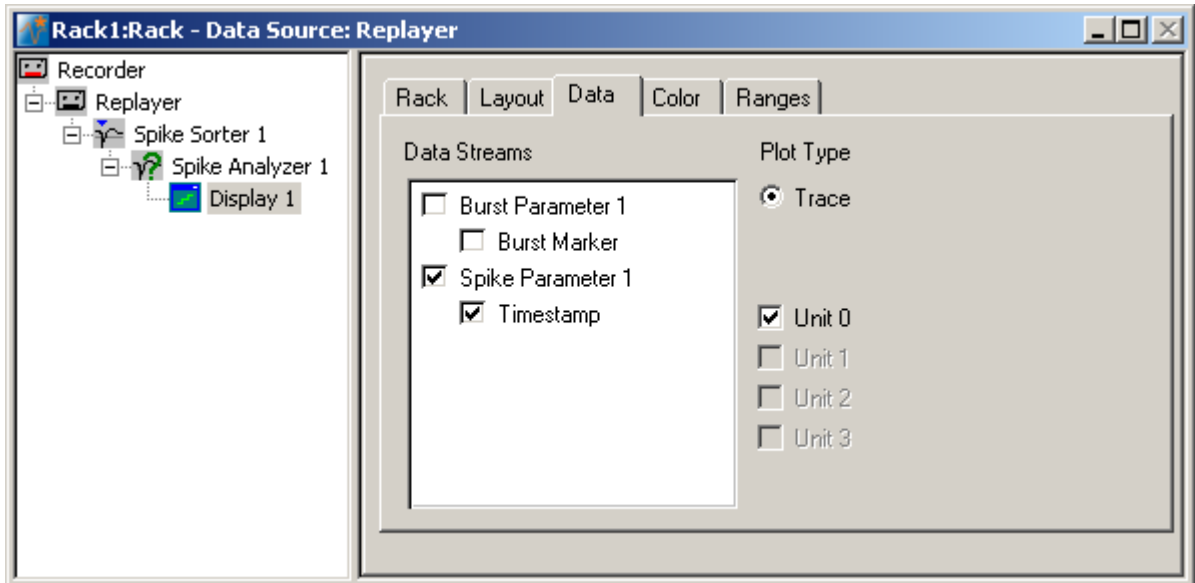

Start the recording or replaying. Zoom into one channel on the display by double click.

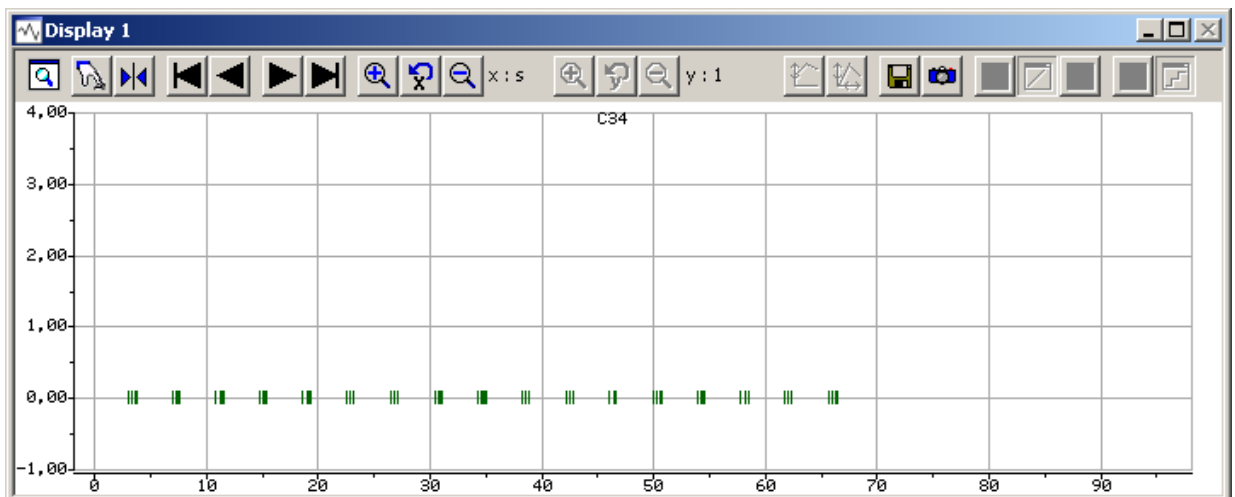

You see the timestamps only. Click  icon to export the timestamp data to one single data file or to export them to one file per channel.

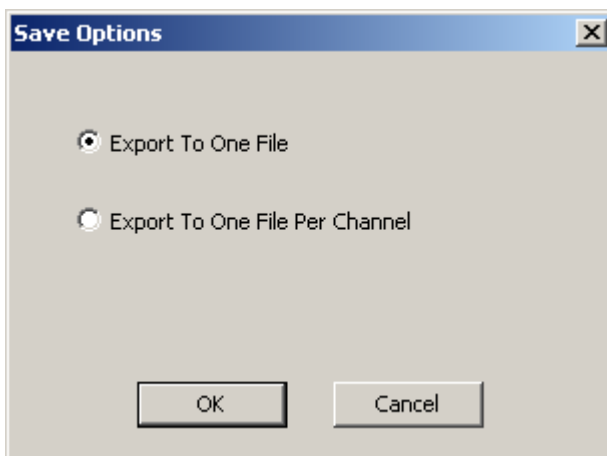

4.14 Analyzing Data

4.14.1 Analyzing Data

Two virtual instruments are provided for data analysis:

Standard **Analyzer** based on **discrete time intervals (bins or region of interest)** for general analyzing purposes (all data streams supported). This Analyzer type is especially useful for **waveform** analysis, for example, for amplitude and slope analysis of evoked responses. Extracted parameters can be graphed in the **Parameter Display**.

Event-based **Spike Analyzer** for extracting **statistical parameters** such as the **interspike interval (ISI)**, timestamps or the spike rate from **Spike** data streams generated by the **Spike Analyzer**. Extracted parameters can be graphed in the **Spike Analyzer Display**. The **Spike Sorter**, the **Spike Analyzer**, and the **Spike Parameter Display** are intended for general event detection and analysis, and are thus useful for both neuronal and cardiac applications.

Both analyzers extract the selected parameters of interest from **any** number of **channels** that you have assigned to it. You can assign only a **single data stream** to an analyzer. Use multiple analyzers for analyzing multiple data streams.

The extracted parameter values form a new data stream, the **Parameter** or **Spike Parameter** stream, which can be processed further by other virtual instruments, for example, the displays mentioned above for online or offline graphing, the **Recorder** for storing the parameters in a data file, and so on. The extracted parameters can be exported in an **ASCII** or a **graphic file** format directly from the **parameter displays**.

4.14.2 Time-Interval Based Analyzer

Extracted Parameters

The following parameters can be extracted with the **Analyzer** from the described data streams.

Parameter	Analyzer input stream	
	Raw Data	Spikes
t-Min	Point of time when minimum occurs, relative to trigger event (to start of recording if no trigger is present)	
t-Max	Point of time when maximum occurs, relative to trigger event (to start of recording if no trigger is present)	
Minimum	Lowest value in time window (minimum)*	
Maximum	Highest value in time window (maximum)*	
Peak-Peak-Ampl.	Amplitude, maximum minus minimum	Amplitude, maximum minus minimum of largest spike in time window
Amplitude (Mean)	Mean value of all data points in time window	
Slope	Slope of linear fit regression line (Least Square Algorithm): A straight line is fitted through the data points in the region of interest. The slope of the straight line is then extracted.	
Slope 10 % / 90 %	Slope of linear fit regression line (Least Square Algorithm) of 10 % / 90 % (or 20 / 80 or 30 / 70) interval, see below.	
Number		Number of spikes in time window
Rate**		Number of spikes in time window per second (in Hz)

* If there are **no** spike events in the time window, the **Analyzer** will extract an **invalid value** (outside the voltage range) as minimum or maximum. The **Analyzer** cannot extract 0 in this case, as 0 can be a valid value for the minimum or maximum, and would thus be misleading.

** Evaluating an event rate in discrete time bins is useful, for example, for analyzing the signal distribution. Often, a continuous analysis of an event rate is more useful, for example, for monitoring the beating rhythm of a cardiac application. For these purposes, use the event-based **Spike Analyzer**.

Slope extraction

Analyzer: Slope 10/90 Extraction

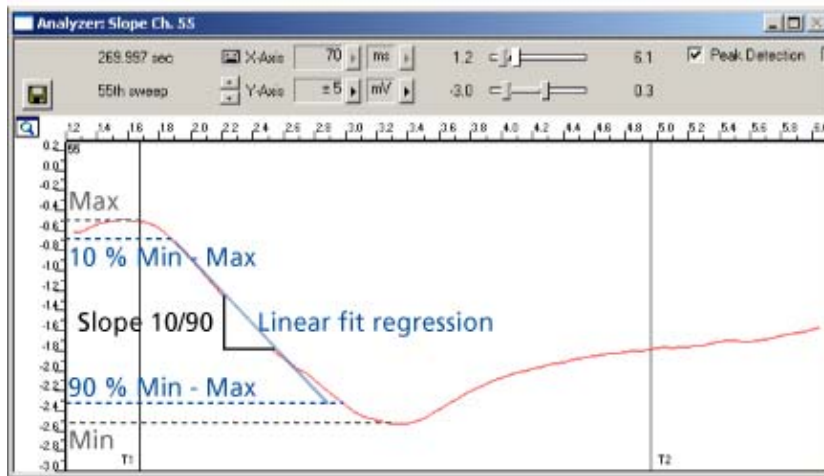

The 10 % / 90 % (or 20 / 80 or 30 / 70) interval of the peak-peak amplitude (stretching from minimum to maximum) in the region of interest is detected. Only data points in this interval are used for the linear regression fit (Least Square Algorithm). The slope of the resulting straight line (not shown in the **Analyzer**) is extracted as the slope.

Triggered Mode vs. Continuous Mode

The **Analyzer** can be operated either synchronized on a trigger event, or continuously.

The selected parameters of interest are extracted from a distinct time window that is either relative to the trigger event (then termed **region of interest**) in triggered mode, or results from splitting up the continuous data stream into **time bins** of equal size.

For example, when analyzing an evoked response such as LTP, the region of interest follows the electrical stimulation. When continuously recording spikes, the spike rate would usually be extracted from 1 s time bins. For slower signals such as cardiac signals, a higher bin size would be more appropriate.

You can use **separate Analyzers** in the same virtual rack configuration for extracting parameters from the **same** channels, but **distinct** regions of interest (for example, for a PPF experiment) or **different** bin sizes (for example, if you want to compare the overall spike rate (measured in 1 s bins) and the organization of spiking activity (in 100 ms bins)).

Defining the ROI (Triggered Mode)

The **Analyzer** estimates the selected parameter type for the region of interest (**ROI**), which is defined in the **ROI** tabbed page of the **Analyzer**. Thus you can analyze the data **relative** to the trigger event. By defining the **ROI**, you can also exclude data from the analysis, for example, if you have stimulus artifacts that would disturb the analysis. See "Triggered Data" for more information.

You can set up several **Analyzers** with independent region of interests on the same or other trigger, for example, for paired pulse analysis. If you have two trigger events shortly after each other, but you want to use only the first event to trigger the **Analyzer**, exclude the second trigger event by choosing a higher dead time in the **Trigger Detector**.

Note: The region of interest can have virtually any time length, even several hours. Of course it is limited by the length of the sweeps. Please make sure that the region of interest does not go beyond the actual sweep. The internal data handling of MC_Rack does not allow to display sweeps that are longer than 2 s. If you need a region of interest that is longer than 2 s, you can define **T2** by entering the appropriate time in the text box, but the **T2** bar will not be displayed in the **Analyzer** window.

1. Set up a rack with a **Trigger Detector** and an **Analyzer**.
2. Click the **ROI** tab of the **Analyzer**.
3. Select the option **Start on Trigger** and choose the appropriate trigger from the drop-down list.

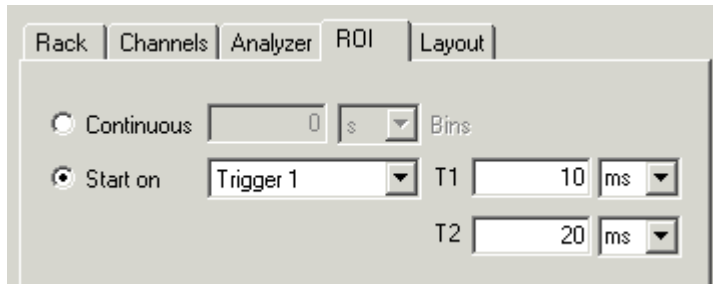

The **Analyzer** display appears. You can change the layout of the Analyzer display in the same way as that of a standard display.

4. You can define the region of interest either with the two bars **T1** and **T2** directly in the display (not available for ROIs of more than 2 s) or by entering the appropriate values into the text boxes in the **ROI** dialog box.

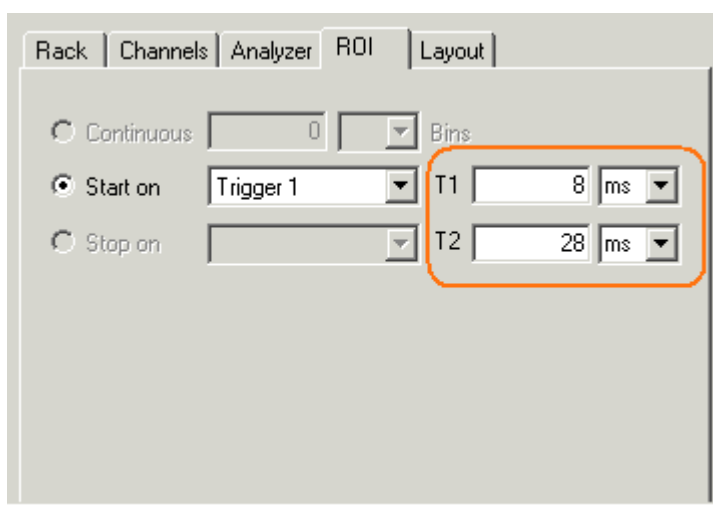
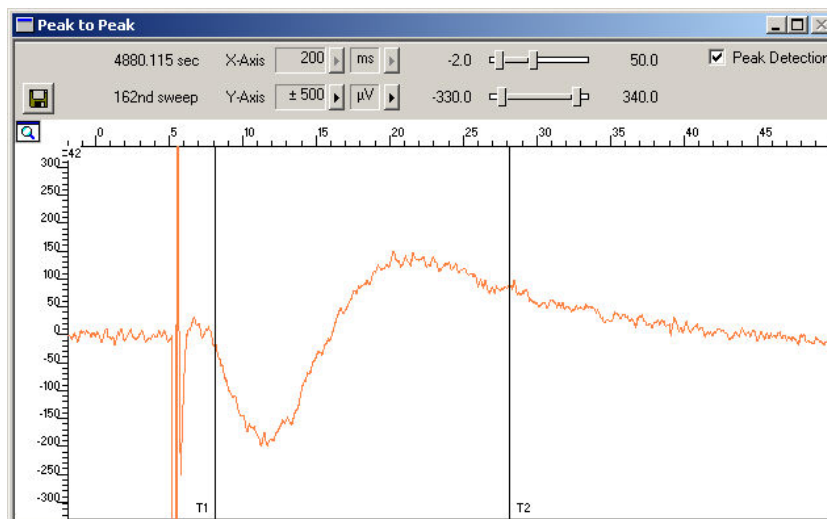

Maximum trigger rate

Please note that the ROI must be defined in a way that the trigger rate does not cause ROIs to overlap.

The *maximum refresh rate* of the **Analyzer display** is determined by the *x axis range* selected from the drop-down list on the display toolbar. In contrast, the **Analyzer functionality**, that is, the *parameter extraction*, is directly related to the *trigger events*, not to the display. The **Analyzer** does **not** allow **overlapping** regions of interest, that is, trigger events that would lead to overlapping ROIs will be **ignored**. In other words, the **Analyzer** will only accept following trigger events **after** time point **T2 minus T1**. (For example, for T1 = 2 ms and T2 = 21 ms, new trigger inputs will be accepted only at 20 ms or later after the first trigger event, because 20 ms plus 2 ms will result in the new T1 = 22 ms, and that is **after** the end of the first ROI = 21 ms.) To avoid misunderstandings, it is recommended that the **refresh rate** of the display corresponds to the expected maximum **trigger event rate**, by either adjusting the **refresh rate** of the **Analyzer**, or by adjusting the **dead time** in the **Trigger Detector**. (If the trigger event rate is *lower* than the display refresh rate, the display will be refreshed *only* at a *new* trigger event.) Example: If you have trigger events at a 10 Hz rate, that is, at a 100 ms trigger interval, but the display refresh rate is set to 200 ms or +/-100 ms, the **Analyzer** display will miss every second sweep, but the selected parameter, for instance the peak-peak amplitude, will be extracted from each sweep, that is, each 100 ms (provided the ROI and trigger settings do not lead to overlapping ROIs).

Maximum trigger rate dependent on ROI settings

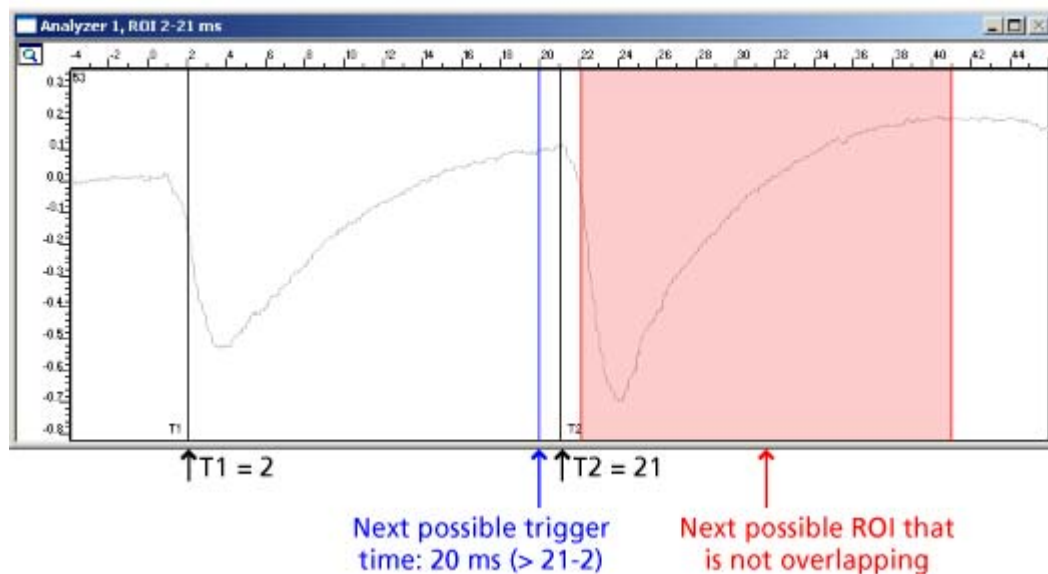

Defining the Bin Size (Continuous Mode)

If you have a continuous data stream, you can define the time intervals from which the analyzer will extract the selected parameter. For example, if you choose intervals of 1 s, the parameter, for example the spike rate, is measured for 1 s intervals. For example, the spike number may be 80 in the first second, 30 in the second second, and 40 in the third second, and so on.

The appropriate bin size depends on the expected **signal rate**, and on the **purpose** of the **Analyzer**.

For example, when monitoring the cardiac signal rate of a cardiomyocyte preparation, it does not make sense to use a 1 s bin size, because the expected signal rate is in the range of 1 Hz, that is, either there is a signal detected in the bin or not. This would result in an extracted rate switching between 0.00 and 1.00 Hz. For this purpose, you would need a higher bin size, for example, 5 s. Please note that a higher bin size affects your resolution on the other hand. That is, with a bin size of 5 s, the rate will be updated only every 5 s.

When monitoring faster signals like neuronal spikes, a bin size of 1 s will generally be fine. For special applications, it can make sense to use a smaller bin size, that is, if you are interested more in the organization of signals than in the overall spike rate. For example, if the **Analyzer** extracts the spike number in 100 ms bins, you will get a pattern of empty and non-empty bins (with a majority of empty bins) if the spike pattern is highly organized in bursts. If the activity is more random or distributed over time, the number of empty bins will be lower. (See example rack `Neurons_DrugApplications_Demo.rck`.)

Another example: You can extract the spike rate in 10 ms bins, and use the false color plot as an "LED display", that is, electrodes will light up each time if there is any spike activity on the electrode, refreshed each 10 ms. (See example rack `Neuro_Spikes_LED_Display.rck`.)

For longterm experiments (over weeks or months), a higher bin size might be appropriate for reducing the amount of data points. For example, you can extract the spike rate each 5 min. (See example rack `SpikeRate_5minBins.rck`.)

1. Set up a rack with an **Analyzer**.
2. Click the **ROI** tab of the **Analyzer**.
3. Select the option **Continuous** and enter the appropriate time window (**Bin**).

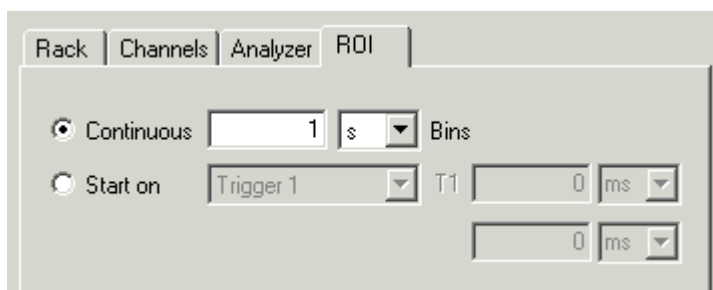

Averaging Extracted Parameters

You can average the parameters over several intervals. For example, if you choose intervals of 1 s, the parameter, for example the spike rate, is measured for 1 s intervals.

For example, the spike number may be 80 in the first second, 30 in the second second, and 40 in the third second, and so on. If you have set the number of windows to 3, the spike rate of the first three intervals (three seconds in total) is averaged, resulting in a mean value of 50 Hz: $(80 + 30 + 40) : 3 = 50$.

If you have triggered data, the time window refers to the region of interest.

Set the **number of windows** to **1**, if you do **not** want to average data.

1. Click the **Analyzer** tab of the **Analyzer**.
2. Under **Window Means**, enter the number of time windows that should be averaged.

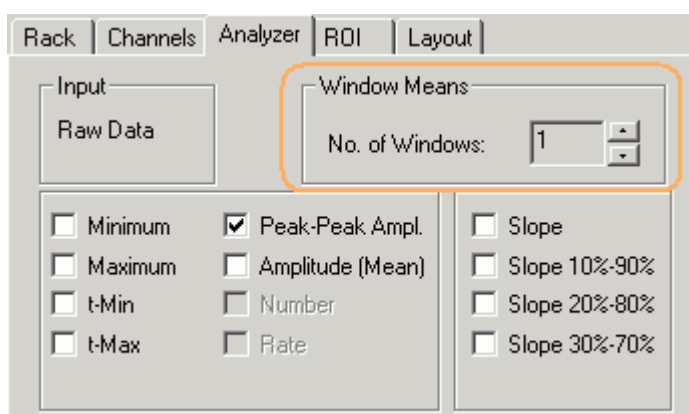

4.14.3 Event-Based Spike Analyzer

Extracted Parameters (Spike Analyzer)



The following parameters can be extracted with the **Spike Analyzer**. Only **Spike** data streams are available as input streams. Each detection event generates a data point.

Interspike Interval	Time interval between detection events (as detected by the Spike Sorter)
Rate	Event rate in Hz (1 divided by the interspike interval)
Timestamp	Indicates a detected spike at a that time, when the spike occurs

4.15 Parameter + Spike Analyzer Display

4.15.1 Plot Types

Two virtual instruments are provided for graphing extracted parameters:

- **Parameter Display** for graphing **Parameter** streams (generated by an **Analyzer**), such as the peak-to-peak amplitude. Click  to add a **Parameter Display** to your rack.
- **Spike Analyzer Display** for graphing **Spike Parameter** streams (generated by a **Spike Analyzer**), such as the interspike interval, timestamps or the spike rate. Click  to add a **Spike Parameter Display** to your rack.

For the **Parameter Display**, four plot types are available: Trace, Color vs. Time, False Color and Number.

For the **Spike Analyzer Display**, only the **Trace** and **Color vs. Time** plot are available (because the **False Color** and **Number Plot** need to be updated on a regular interval and not on events for proper operation. You can choose between the plot types on the **Data** tabbed page of the display.

- **Trace** plot: Parameter values are plotted as a **line** with or without markers displayed at each data point. Default: Parameter values are plotted as markers at each data point (dots without line).
- **Color vs. Time**: Displays the data as colored bars over time. Similar to the false color plot, but with the time information.
- **False Color**: Shows the spatial distribution of signals in a two-dimensional false color map.
- **Number**: Displays the actual value as a number.

4.15.2 Trace Plot

- Parameter values are plotted versus time in a **Trace** plot. You can choose between showing **markers** (scatter graph), **lines**, and **both markers and line** by pressing the appropriate graph option button in the display toolbar. See also Parameter Display Tools.
- In the **Spike Analyzer Display**, you also have the option to choose between a **straight line** and a **horizontal step line** graph by pressing the appropriate graph option button in the display toolbar. These options are only available if either the **line** or **marker and line** option is active. See also Parameter Display Tools.
- Several data streams, for example spike rate and peak-to-peak amplitude, can be shown in the same plot.
- Different data streams are plotted in different colors.

4.15.3 False Color Maps

In the **Color vs. Time** and the **False Color** plot, color values or gray-scale intensities are assigned to parameter values.

The colors are chosen from a **Color Map**. The following pre-set color maps are available: **Jet**, **Hot**, **Cool**, **Gray** and **Jet reverse**. Each color map consists of 64 different colors arranged in a particular way.

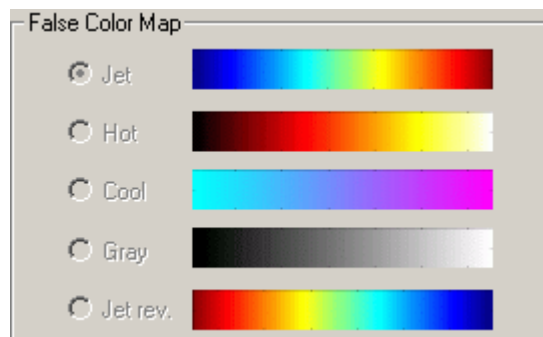

The range of the y-axis (defined in the display) is assigned to the selected **Color Map**, that is, the leftmost color corresponds to the minimum y-value (**Min**), and the rightmost color corresponds to the maximum y-value (**Max**). The interval between min and max is straight-proportional to the colors in-between. For example, **low** values can be displayed in **cool** colors, and **high** values in **warm** colors (false color map **Jet**). Or you can display low values in dark gray scales, and high values in light gray scales (**Gray**).

The color of the actual value is looked up from the **Color Map** accordingly. Parameter values outside the defined min/max range are plotted in Black.

Example: If the range was set from min = 0 Hz to max = 64 Hz, each color of the map would correspond to 1 Hz steps. Spike rates lower than 1 Hz would then be plotted as the first (leftmost) color of the color map, spike rates between 1 Hz and 2 Hz would be plotted as the second color of the color map, and so on. A value above 64 Hz would be plotted in black.

False Color Map

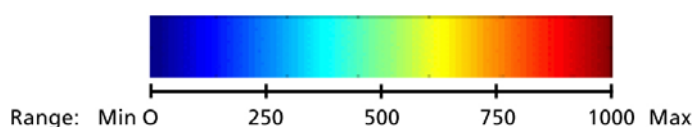

Each y-value in the specified range is mapped to 1 of 64 colors. In this example, the range is set from 0 to 1000 μV . Thus, 250 μV gives a blue color, 500 μV green, 750 μV orange, and so on.

4.15.4 False Color vs. Time (Plot)

In a **Color versus Time** plot, color values or gray-scale intensities are assigned to parameter values. This feature can be used to enhance the visibility of details in the plot. You can choose between four different false color maps.

The **Color vs. Time** plot shows the data as **colored vertical bars over time**. Each y-value is assigned to one of 64 colors (defined by the Color Map).

Note: Only **one** input data stream can be displayed here.

4.15.5 False Color Plot

In a **False Color** plot, color values or gray-scale intensities are assigned to parameter values. This plot type is very useful for two-dimensional applications. It gives you a good imagination of different areas of activity in your preparation.

MC_Rack Manual

You can choose between four different false color maps. The **False Color** plot shows only the current values as colors without information about the time. Each parameter value is assigned to one of 64 colors (defined by the Color Map). There is no time axis, the plot is refreshed according to the **Window** settings of the **Analyzer**.

Scrolling back and forward is not available for this plot type, but will be enabled in future versions. The scroll arrows are present but inactive.

Note: Only **one** input data stream can be displayed in a **False Color** plot.

The following screen shots show a **False Color** plot (**Color Map Jet**) of a spike rate. An **Analyzer** has been used to extract the spike rate and a **Parameter Display** to display the **False Color** plot.

The first screen shot shows the right region firing, the second shows the left slice firing. You see now clearly that both brain slices fire independently.

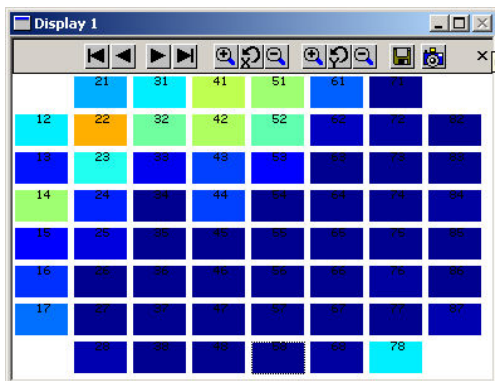
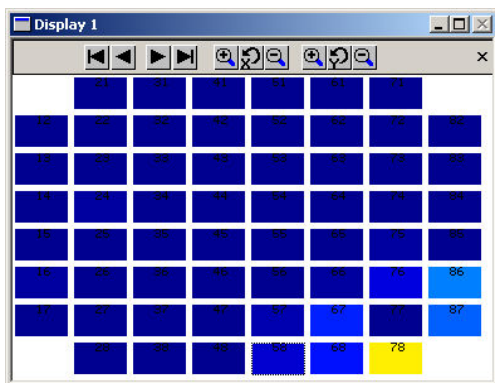

4.15.6 Number Plot

The **Number** plot shows the current parameter value (for example the spike rate of a neuron) as a number.























Note: Only **one** input data stream can be displayed in a **Number** plot.

Scrolling back and forward is not available for this plot type, but will be enabled in future versions. The scroll arrows are present but inactive.

4.15.7 Parameter/Digital Display Tools + Settings

Each **Parameter Display** or **Digital Display** has a toolbar at the top of the window.



	Zoomed Channel:	This icon appears, when you have zoomed a single channel.
	Apply to All:	(In zoom mode) Applies the display settings to all channels.
	Show/Hide Measure Tool:	A vertical bar in the color of the data channel is shown that displays the x- and y-value of the intersection point. You can position the bar with the mouse. Right-click the bar for several options, such as measure the peak-peak amplitude or period. (Available only in Zoomed Channel mode.)
	Start Position:	Moves displayed region to the start position.
	Back:	Rewinds displayed region.
	Forward:	Fast-forwards displayed region.
	End Position:	Moves displayed region to the last position.
	Zoom In x:	Scales up the x-axis.
	Reset x:	Resets scaling of the x-axis.
	Zoom Out x:	Scales down the x-axis.
	Zoom In y:	Scales up the y-axis.
	Reset y:	Resets scaling of the y-axis.
	Zoom Out y:	Scales down the y-axis.
	Zoom Min / Max:	Adjusts the min and span properties on the y-axis to ensure that all data is kept in the visible display area. "Empty" display areas are not adjusted.
	Zoom to Fit:	Adjusts the ranges of the y-axis to exactly fit all displayed data. "Empty" display areas are removed.
	Save Plot:	Saves the displayed channels in an ASCII file format.
	Snapshot:	Takes a screenshot (*.wmf, *.bmp, *.jpg) of the display.
	Markers:	Shows markers for data points only, without connecting line. (scatter graph)
	Trace:	Shows connecting lines between collected data points.
	Markers + Trace:	Shows markers and connecting line .
	Straight Line Mode:	Data points are connected with straight lines . This option is available only if either the Trace or Marker + Trace option is active.
	Horizontal Step Line Mode:	Data points are connected by a horizontal "step" connection . A step connection is constructed by connecting each data point at a right angle. The initial line for each data point is horizontal. This option is available only if either the Trace or Marker + Trace option is active.

Note: The **Save** and **Snapshot** commands are not available during data acquisition / replaying.

MC_Rack Manual

Note: In general, all buttons apply only to the displayed channels. If, for example, 64 channels are displayed, moving and zooming of the axes will apply to all channels. If, on the other hand, a single channel was zoomed to its full size by double-clicking it, all toolbar buttons would correspond only to this particular channel. You can apply the settings to all channels by clicking the **Apply to All** button.





Zooming a channel

All available channels are shown in the parameter display to provide an overall view of the ongoing activity.

- Simply double-click a channel to have a closer look at it. The magnifying-glass icon on the top left indicates that you are in zoom mode. The channel number is displayed in the display.
- Double-click the zoomed channel again to restore the overall view.





Scrolling back and forward

You can scroll the data forward and backward along the time axis. You are able to look for a region of the plot that you are interested in and snapshot the displayed region.

- On the toolbar, click  to scroll backward and  to scroll forward.
- Click  to jump to the beginning of the plot.
- Click  to jump to the end of the plot.

Scaling the axes

You can scale the x- and y-axis up and down independently. The left button array on the toolbar corresponds to the x-axis and the right button array to the y-axis.

- Decide which axis you like to scale and click the corresponding button  to zoom the plot in and  to zoom it out. The display will be updated accordingly.
- To reset the scaling of the x-axis to the set ranges, click .
- Likewise, click  to reset the scaling of the y-axis.

Measure tool options

The measure tool allows the user to measure data values in the **Parameter Display** and **Spike Parameter Display**. The default cursor is a vertical bar with a label showing the x and y value of the intersection point with the data trace. There are several advanced features as described in the following.

- Move the mouse pointer over the clamp control cursor / measure tool until the mouse pointer becomes a hand and then press the right mouse button to show the options.

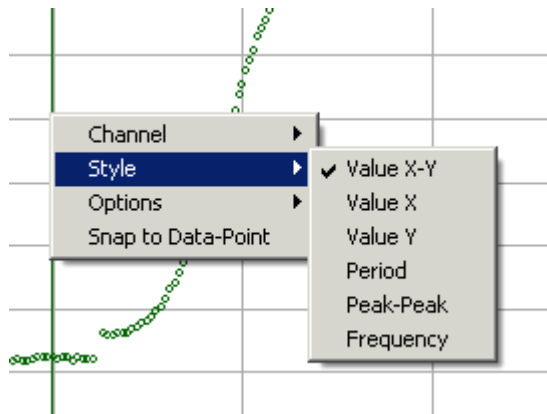

Channel		Switch between the y value channels. See the Data tabbed page of the Spike Parameter display for available channels.
Style	Value x-y	Default option. Label shows x and y values of intersection point.
	Value x	Label shows only x value of intersection point.
	Value y	Label shows only y value of intersection point.
	Period	Label shows the value of the x distance between the two vertical bars.
	Peak-Peak	Label shows the value of they y distance between the two horizontal bars.
	Frequency	Label shows the value of the x distance between the two vertical bars as a frequency in Hz.
Options	Hide hint on release	The cursor label is displayed only when the mouse pointer rests on the cursor and the left mouse button is pressed.
	Use Channel Color	The measure tool has the same color as the graph.
	Flip Alignment	The alignment of the cursor label is flipped from left to right and vice versa.
Snap to Data Point		The measure tool snaps to the next data point.

4.15.8 ASCII Export of Extracted Parameters

Click  to save the complete data streams of the displayed channels as a tab-delimited ASCII file (text without formatting). You may then send this data to an editor or to your custom analyzing software, for example. ASCII export is possible with all four parameter plot types.

Exporting data is only possible when you have stopped the data acquisition / **Replayer**. The **Save** button will then reappear on the toolbar.

The created file has the following structure. The screen shot shows an exported parameter Trace plot opened with a standard spreadsheet program.

	A	B	C	D	E	
1	T[s]	21-Rate[Hz]	31-Rate[Hz]	41-Rate[Hz]	51-Rate[Hz]	61-
2	0.1	0	0	0	0	
3	0.2	0	0	0	10	
4	0.3	0	0	0	0	
5	0.4	0	0	0	0	
6	0.5	0	0	0	20	
7	0.6	0	0	20	10	
8	0.7	0	0	0	20	
9	0.8	0	0	0	10	
10	0.9	0	0	0	20	
11	1	0	0	0	0	
12	1.1	0	0	0	0	
13	1.2	0	0	0	0	
14	1.3	0	0	0	0	

- The **header** of the ASCII table shows the **channel numbers**, the **parameter type** and the **measuring units**.
- The first column contains the time axis values.
- The following columns contain the analyzed parameter values.
- The format is tab-delimited ASCII, so that the file can easily be loaded into other applications.

Note: Only the channels shown on the display are saved. If you want to save all channels in a single file, press the Save button when all channels are displayed. If you want to save the parameter values of a single channel only, zoom this channel and then press the Save button.

4.15.9 Image Capture

You can take a screen shot of the **Parameter Display**. On the display toolbar, click the **Snapshot** button  to take screen shots of the displayed channel(s). Each channel is captured separately with only one click. The file name is extended by the channel number.

The pictures are screen shots that means that the resolution of the output file resembles the screen resolution, that is, 72 dpi. If you then print the image with a 300 dpi resolution, the size of the image will be reduced accordingly. Therefore, you should expand the display as much as possible to obtain a big image with a good printing quality. The higher resolution you need, the bigger has to be the display.

The following image file formats are supported.

- (*.emf), Enhanced Meta File format
- (*.bmp), Bitmap
- (*.jpg), JPEG

Note: Only the channels shown on the display are captured. If you want to save all channels, use the image capture tool when all channels are displayed. If you want to capture a single channel only, zoom this channel and then press the Snapshot button.

4.16 Averager

4.16.1 Averaging Data Sweeps

The **Averager** adds up triggered sweeps successively. You can use the **Averager** to reduce the noise level and to enhance your signals, for example, to detect field potentials or for evoked potential analysis.

Noise usually stems from arbitrary signals, where "real" signals should follow a pattern, that is, the signal event is linked to a stimulus or a trigger signal. Therefore, the added up noise signals cancel each other out and the response signals become visible. Be aware of the fact, that you also will enhance artifact signals that are linked to the trigger event for any reason.

The **Averager** works only in a triggered mode. It adds up triggered sweeps successively until either the preset numbers of sweeps has been reached, or the reset condition becomes active and restarts the **Averager**. That means the following. The first plotted sweep shows original data. The second sweep represents the sum of the first and second sweep. The third sweep adds up the first three sweeps, and so on, until either the reset condition becomes active, or the set number of sweeps has been reached. The window extent of a sweep is specified on the **Settings** tabbed page of the **Averager**.

You can average Electrode Raw Data, Analog Data, and Filtered Data.

- If you replay triggered data, use the trigger that you used for recording the data file. If you average online, or continuously recorded data, you have to set up an **Averager Trigger**. For more information about defining triggers, please refer to "Triggering MC_Rack".
- You can specify the number of sweeps that will be averaged. For example, you can apply a stimulus 100 times and average all sweeps. When the set sweep number has been reached, the last sweep is saved (in recording mode). In addition to the averaged data stream, a trigger data stream is created (**Avg Trigger**). This trigger event is the time point of the last sweep. This means, if you replay the file, you should start a **Display** (or any other tool) for processing the averaged data on this trigger event.
- You can define a **Reset Trigger** that restarts the **Averager (Reset Trigger)**. For more information about defining triggers, please refer to "Triggering MC_Rack".
- You also can manually restart the **Averager** by clicking **Reset**.

Note: The *maximum refresh rate* of the Averager is determined by the *window extent* selected on the Settings page of the Averager. You should make sure that the window extent corresponds to the expected maximum trigger event rate. Example: If you have trigger events at a 10 Hz rate, that is, at a 100 ms trigger interval, but the window extent is set to 200 ms, the Averager will miss every second event.

Averager settings

Defines the start point of the **Averager** sweeps. In this example, 50 ms before the trigger event.

Defines the window extent of the sweeps.

Select a trigger to control the **Averager**. You can define a trigger in the **Averager**. This trigger is called **Averager Trigger**.

When the set number of windows have been averaged, the last averaged sweep is recorded (in recording mode).

Select this option if you like to use a break condition (**Reset Trigger**) to restart the **Averager**.

Click **Reset** to restart the **Averager** manually.

The screenshot shows the 'Settings' tab of the Averager dialog. It includes the following controls:

- Start on Trigger:** A radio button that is selected.
- Pretrigger:** A text input field containing '-50' and a dropdown menu set to 'ms'.
- Window Extent:** A text input field containing '500' and a dropdown menu set to 'ms'.
- Trigger:** A dropdown menu currently showing 'Averager Trigger'.
- Number of Windows to sum up:** A spinner control set to the value '10'.
- Reset:** A button located to the right of the spinner.
- Reset Trigger active:** A checked checkbox.

Note: When recording averaged data, you can save the data only continuously. The averaged data stream is recorded "triggered", that means, only the last sweep of the set sweep numbers is saved. For example, if you set the sweep number to 100, every 100th averaged sweep is saved. If you stop the recording or restart the Averager before the last sweep has been reached, no data will be saved at all.

4.17 Sound Output

4.17.1 Sound Output with MC_Card

You can convert signals from one channel into sound. A computer with a sound card and speakers or headphones is required. You can use this feature to make Electrode Raw Data hearable, for example, or to replay recorded sound. Analog Raw Data, Electrode Raw Data, and Filtered Data can be converted into sound.

You can use an analog channel as a sound input and record any sounds or voice. Thus you can add spoken commentary to document the recorded data. Please note that microphones do not generate enough voltage to directly connect them to the analog inputs. You need to use some kind of amplifier that adapts the output voltage of the microphone to the input voltage range of the MC_Card.

Note: You can add only one Sound instrument to your rack, and you can convert only one channel into sound. The sound output is NOT real time.

Click the "Sound" icon  in the main menu toolbar. The sound device is added in the virtual tree view pane. Click "Sound" tab.

Sound

You can deactivate the sound output by deselecting the On option.

Select the channel you like to convert into sound.

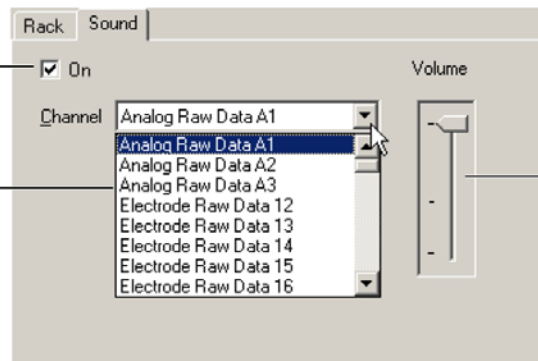

Drag the **Volume** slider up to increase the volume, or down to decrease the volume.

4.17.2 Audio Out with USB-ME Data Acquisition

Using a **MEA2100-System** or an **USB-ME** device you can additionally transfer electrode activity into sound with the "**Audio Tool**" feature. You can convert signals from one channel into mono sound, and signals from two channels into stereo sound. In contrast to the sound audible with the usual "Sound" output, the sound of the signals generated with "Audio Tool" are in real time. The sound is audible during data acquisition. It is possible to convert Electrode Raw Data and Analog Raw Data into sound, but it is not possible to add spoken commentary.

Add a MEA2100-System, an USB-ME64-, an USB-ME128- or an USB-ME256-System in Data source setup. In Virtual Device Configuration choose "1x64, 1x128 or 1x256". Click "Audio" tab.

Connect the "**Audio OUT**" of the rear panel of the USB-ME device with an audio system or with the speakers of the computer. For more information, please refer to the USB-ME-System manual.

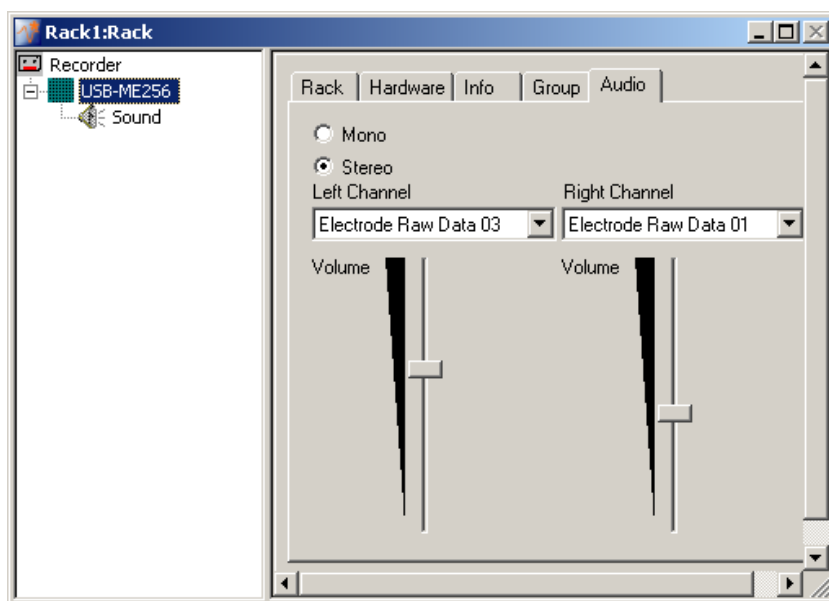

Select "**Mono**" for converting signals of one electrode channel into mono sound. The dialog will be adapted immediately. Select "**Stereo**" for converting signals of two electrode channels into stereo sound. Select the desired electrodes from the "Left Channel" and "Right Channel" drop down menu. Drag the slider to adjust the volume. The Audio Out also can be used as a real-time Analog Out to transfer the data of up to two channels in analog form to other applications.

It is possible to add the usual sound output as well. Click the sound icon  in the main menu toolbar.

5 Data Export

5.1 About Data Export

The data acquisition and analysis program from Multi Channel Systems MC_Rack provides tools for a user friendly online and offline analysis of basic parameters like peak-to-peak amplitudes, spike rates, and so on. For more advanced analysis methods like tetrode analysis, or analyzing sorted spikes, you can easily transfer your data files to external analysis programs. Several free or commercially available programs support data files generated with MC_Rack (*.mcd files). For all other programs, the add-on program MC_DataTool conveniently exports MC_Rack data files to universal file formats like **ASCII** (*.txt), **binary** format (*.raw), or **Axon Binary File** (*.abf).

Unless otherwise noted, the mentioned programs are based on a Windows operating system. For more information, please refer to the corresponding documentation of the import filters of the mentioned programs. Please note that MCS cannot provide support for third party programs.

Programs for offline analysis

This table gives you an overview about the wide range of possibilities of further processing your data. The list of programs is not complete; and Multi Channel Systems does not intend to favor some programs over others. If you do not find your favorite graphing or analysis program in this chapter, please ask your local retailer or Multi Channel Systems whether this program would support data files generated with MC_Rack. Please note that the feature list may not be up to date. Please ask the provider or developer of the program of interest for more information.

The file format column specifies the file format that can be imported into the program. In many cases, the original *.mcd file format is supported.

For **extracting graphs**, for example, for presentations, you can use the Image Capture feature of the **Parameter Display**. If you like more features, Multi Channel Systems recommends to use a commercially available screen shot program, for example, SnagIt from TechSmith Corporation (www.techsmith.com). If you like to change the resolution or the color of the traces, for instance, you can export the data as **ASCII** either directly from the MC_Rack display or from the *.mcd data file with MC_DataTool and then import the ASCII file into the graphics program of your choice.

<i>Program</i>	<i>License</i>	<i>File format</i>	<i>Signal type</i>	<i>Data source</i>	<i>Application Neuro</i>	<i>Application Cardio</i>
MeaTools	Freeware	.mcd (MC_Rack)	Spikes, field potentials, cardiac signals	MEAs	Analysis, for example spike sorting, PSTH, correlational analyses, min/max, differentials, statistics, principal component analysis, clustering	3-D movie of wave propagation, local activation time mapping, time delays
Offline Sorter	Plexon	.mcd (MC_Rack)	Spikes	Single electrodes and tetrodes	Spike sorting, tetrode analysis	
Spiker	Freeware	binary (MC_DataTool)	Spikes	Tetrodes	Spike sorting, tetrode analysis	

Spike2	CED	.mcd (MC_Rack)	Spikes, field potentials		Analysis, for example spike sorting, PSTH, correlational analyses, filters, tetrode analysis, waveform analysis	
NeuroExplorer	Nex Technologies	.mcd (MC_Rack)	Spikes, event data		Statistical analysis, for example PSTH, correlational analyses, histograms, rasters, activity graphs and maps, interspike intervals, burst analysis, principal component analysis	
CMC Tools	University Freiburg	.mcd (MC_Rack)	Cardiac signals	MEAs		QT duration, signal frequency, RR interval
Mini Analysis Program	Synaptosoft Inc.	ABF (MC_DataTool)			Event based analysis, for example, spike detection, field potentials, statistics, digital filters, mathematical operations, histograms	Event based analysis, for example, detection of waveform patterns like QT, inter- spike-interval (beating rate), statistics, digital filters, mathematical operations, histograms
Excel	Microsoft	ASCII	Parameters		Graphing, general statistics	Graphing, general statistics
Origin (and similar programs)	OriginLab	ASCII	All		Graphing, general statistics	Graphing, general statistics
AxoScope	Axon	ABF (MC_DataTool)	Raw data	Up to 16 electrodes	Mathematical transformation of data, cursor-related measurements, report sheets	
DataAccess Pro	Bruxton	.mcd (MC_Rack)	All		Export filters for other programs	Export filters for other programs

5.2 Graphs for Presentations

5.2.1 Low Resolution Pics (Screen Shots)

- You can use the Image Capture feature of the **Parameter Display** for a basic picture of the displayed channels.
- If you want to make a screen shot of the complete **program window**, you can use the built-in snapshot feature of the Windows operating system (press ALT + PRINT SCREEN for copying the active program window or PRINT SCREEN alone for the complete screen content). These keyboard shortcuts copy the window content as a bitmap graphic to the clipboard, and you can then paste the graphic into your custom graphics program.
- If you like more features, Multi Channel Systems recommends to use a commercially available screen shot program, for example, Snagit from TechSmith Corporation (www.techsmith.com). This method for acquiring graphic material is very easy to use and sufficient for most applications.

Screen shots always have the resolution of the screen you use (generally 72 dpi). This resolution is fine if the output medium is on screen, too, for example, for Power Point presentations or web sites.

If you need pictures with a higher resolution for printed documentation, you can drag the display as big as possible on your screen and then resize the picture afterward with the screen shot or graphics program of your choice. Note that 150 dpi is fair enough for most common printers. You will not see the difference if you use a higher resolution. You will only need higher resolution pictures for offset printing.

Remember that you can change the color of raw data traces, if you like, before making the screen shot.

Example:

If you need a picture with a resolution of about 150 dpi, you can enlarge the display to double its size and then take a screen shot of the display. Then, you resize the picture to half its size. Make sure that you only modify the size, and not resample the picture (which would keep the resolution and simply make the image smaller). The picture has now the double resolution (= 144 dpi).

5.2.2 Working with Graphics Programs

For most applications, screen shots have a sufficient quality and size. If you need higher quality pictures for offset printing or a bigger size of the picture than your screen allows, or if you like to modify the graph like changing the background color, and so on, you will need a **graphics program**. There are several programs for **scientific applications** that allow creating nice graphs like Origin from OriginLab Corporation (www.originlab.com), and also several programs for designers like Adobe Illustrator, and spreadsheets like Microsoft Excel.

MCS does not recommend specific programs; it is up to you and your needs which programs you prefer. For small graphs with only a few data points (for example parameter plots), graphics programs for designers or spreadsheets are fair enough. You may have more control on the design of the graph with these programs as well. But for raw data or plots with many data points, scientific graphing software like Origin is strongly recommended, because most graphics and spreadsheet programs allow only a limited number of data points, 32000 for example. If you use a sampling rate of 25 kHz, for example, this means that a raw data stream of a length of only about **1 second** (1.28 second) exceeds this limit! Also, most programs are slowed down if you enter a lot of data points, because they have not been designed for handling this amount of data. So make sure that the program you are going to use is meant to handle the data you like to show.

The mentioned programs and most other allow ASCII import. MCS recommends to **export** the data as **ASCII** either directly from the MC_Rack display or from the *.mcd data file with MC_DataTool and then **import** the ASCII file into the graphics program for creating and designing the graph.

You can also use the commercially available program DataAccess Pro from Bruxton (www.bruxton.com) to open *.mcd files directly and import data streams into several scientific graphing and analysis programs.

5.3 Extracting Spikes

5.3.1 Spike Sorting

MEATools and Matlab for data recorded from MEAs

Prof. Dr. Ulrich Egert from the university in Freiburg, Germany, has designed the MEATools (www.brainworks.uni-freiburg.de) based on Matlab for analyzing MC_Rack data files recorded from microelectrode arrays (MEAs). MEATools is available for free and has a graphical user interface. It is not as easy to use as most commercially available programs, of course. It is especially useful if you are interested in programming Matlab routines yourself. MEATools is a collection of useful tools for analyzing spikes and field potentials.

With MEATools, you can sort spikes based on identical principal components, estimate the spike rate based on moving window rate estimation, calculate PSTH and dot displays, and calculate burst rates and burst positions.

You can sort spikes based on clustering:

- Pair wise projections of the principal components and spike minima vs. each other (calculated individually from the spikes on each electrode)
- Projections of the spike minimum vs. time
- Scaling factor of the mean spike cutout

You can review the clusters with different colors for spikes from different clusters, and review spikes colored for their cluster identity as cutouts against time.

MEATools allows to open *.mcd files directly. In addition to Matlab version 5.3 or higher, you will need the MC_Stream.dll and MCStreamMEX.dll files installed on the computer from which you want to run the MEATools. All required files except Matlab are delivered with MC_Rack. Please see the documentation in the **MCStreamSupport** subfolder of the MC_Rack program folder for more information. The **Common Program Files** folder (for example c:\Program Files (x86)\Common Files\Multi Channel Systems\) contains the **MC_Stream.dll**; the **Matlab** subfolder contains the other files that are needed for using the MEATools.

Offline Sorter for single electrode or tetrode recordings

Offline Sorter is a commercially available program from Plexon (www.plexoninc.com) for sorting spike waveforms collected either from a single electrode or tetrode. The sorting is based on a 3-D principal component algorithm. Offline Sorter supports raw data and spike data streams from *.mcd files.

Tetrode analysis with Spiker

Spiker is a free program with graphical user interface from a research group at the University of California, San Francisco, USA (<http://millerlab.ucsf.edu/Software/Spiker/spiker.html>) for viewing and interactive clustering of tetrode (multielectrode) recordings.

You can load raw data files generated with MC_Rack in a **binary file format** with Spiker. Use the MC_DataTool to convert MC_Rack data streams into binary file format.

Spike2 for spike sorting and tetrode analysis

Spike2 is a commercially available spike analysis program with a graphical user interface and scripting language from Cambridge Electronic Design Limited (www.ced.co.uk).

Spike2 automatically creates templates from raw spike data based on user-defined parameters. Spike2 can cluster spike data using principle component analysis or user-defined spike waveform measurements. Clusters can be formed automatically with the K-means algorithm or by cutting clusters manually using ellipses. 3-D rotation of clusters and replay of activity enables better viewing of cluster formations.

Spike2 allows to open *.mcd files directly.

5.3.2 General Spike Analysis

Spike2

Spike2 is a commercially available spike analysis program with a graphical user interface and scripting language from Cambridge Electronic Design Limited (www.ced.co.uk).

Waveform analysis includes averaging, power spectra, waveform discrimination and measurements of areas, spike sorting and clustering, means, gradients, RMS amplitudes, SD etc, based on cursor positions or automatic feature detection. Event processing includes INTH, PSTH, rasters, sorted rasters, filtering options, and event correlations.

Spike2 allows to open .mcd files directly.

NeuroExplorer (NEX)

NeuroExplorer is a commercially available program with a graphical user interface from Nex Technologies (www.neuroexplorer.com) for analyzing neurophysiological data. It features standard histogram, raster, and correlational analyses for both point events (for example spikes, behavioral events) and continuous variables (e.g. field potentials), joint PSTH, burst analysis and many more analysis options and functions. It is available from local distributors for MCS products.

5.4 Analyzing Cardiac Signals

5.4.1 Wave Propagation

Exporting spike rates or spike event times to Excel or Origin

For analyzing the contraction rate and spatio-temporal patterns of arrhythmia, the MC_Rack Spike Sorter and Analyzer are usually sufficient. You can then extract the spike rate or the spike events directly from the display or with the MC_DataTool and import them into Excel or Origin. Basic two-dimensional false color plots are also supported by MC_Rack.

MeaTools and Matlab for data recorded from MEAs

For more detailed analysis or graphics, like more advanced **false color** or **delay contour plots**, **3-D movies** of the **propagation**, **local activation time mappings**, or analysis of **time delays**, you can use the free MEA Tools.

Prof. Dr. Ulrich Egert from the University of Freiburg, Germany, has designed the MEATools (www.brainworks.uni-freiburg.de) based on Matlab for analyzing MC_Rack data files recorded from microelectrode arrays (MEAs). MEATools is available for free and has a graphical user interface. It is not as easy to use as most commercially available programs, of course. However, it is especially useful if you have interest in programming Matlab routines yourself. MEATools is a collection of useful tools for analyzing spikes and field potentials.

MEATools allows to open "*.mcd" files directly. In addition to Matlab version 5.3 or higher, you will need the MC_Stream.dll and MCStreamMEX.dll files installed on the computer from which you want to run the MEATools. Both files are delivered with MC_Rack. Please see the documentation in the MCStreamSupport subfolder of the MC_Rack program folder for more information.

5.4.2 Waveform Shape and QT-like Interval

For drug screenings, the analysis of the waveform, especially of the **field potential duration**, is of main interest. The field potential duration corresponds to the action potential duration, that is, the **QT interval** in an electrocardiogram. It is generally measured from minimum of the Na⁺ peak to the maximum / minimum of the IKr current peak.

Matlab based Cardiomyocyte Toolbox (CMC Tools)

This toolbox programmed by Prof. Dr. Ulrich Egert (www.brainworks.uni-freiburg.de) from the University of Freiburg, Germany, allows an **automated detection** of the Na⁺ peak to the maximum / minimum of the IKr current peak, and thus automates the measurement of the field potential duration, the **QT-like interval**. Also, the **RR interval**, and the **signal frequency** can be analyzed.

The CMC Tools are based on Matlab, and are commercially available under licence of the University Freiburg. Please contact Prof. Dr Ulrich Egert for details.

Mini Analysis Program (Synaptosoft Inc.)

The commercially available program Mini Analysis Program analyzes signal events and time stamps, for example, the **automated detection** of the Na⁺ peak and the extraction of the inter-spike-interval, providing information on the signal frequency and on arrhythmies, or the extraction of the **QT-like interval**.

You can convert the recorded MC_Rack file into the ABF format and then load it directly into Mini Analysis Program.

5.5 Extracting Parameters

5.5.1 Exporting Parameter Streams to Excel

You can use the **ASCII export features** of the **MC_Rack displays** or of **MC_DataTool** to export parameter streams to an ASCII file and then import the ASCII file to Microsoft Excel.

You can also use the commercially available program DataAccess Pro from Bruxton (www.bruxton.com) to open .mcd files directly and import data streams into Excel.

5.6 MC_DataTool

5.6.1 About MC_DataTool

MC_DataTool is an add-on program exporting data retrieved with the MC_Rack program. With MC_DataTool, you can fast and conveniently convert MC_Rack data files (*.mcd files) into other file formats.

Supported are the following input data streams: **Electrode Raw Data, Analog Raw Data, Filtered Data, Spikes, Parameter, Trigger, Digital Data**. Specific traces can be selected and saved for further processing as an **Axon Binary File** (*.abf), an **ASCII file** (*.txt), or a **binary file** (*.raw). The **Averager** input stream can be saved as ASCII file only.

6 Troubleshooting

6.1 Technical Support

Please read the Troubleshooting part of the MC_Rack Manual / Help first. Most problems are caused by minor handling errors. Contact your local retailer immediately if the cause of trouble remains unclear. Please understand that information on your hardware and software configuration is necessary to analyze and finally solve the problem you encounter.

If you have any questions or if any problem occurs that is not mentioned in this document, please contact your local retailer. A list of local retailers for MCS products can be found on the MCS web site. <http://www.multichannelsystems.com>. The highly qualified staff will be glad to help you.

Please keep information on the following at hand

- Description of the error (the error message text or any other useful information) and of the context in which the error occurred. Try to remember all steps you had performed immediately before the error occurred. The more information on the actual situation you can provide, the easier it is to track the problem.
- The serial number of the MC_Card. Click Data Source Setup on the Edit menu to display the serial number.
- The MC_Rack software version you are currently using. On the **Help** menu, click **About**. The displayed dialog box shows the version number.
- Your operating system (Windows 7, Vista or XP).
- The hardware configuration (microprocessor, frequency, main memory, hard disk) of the connected computer. This information is especially important if you have modified the delivered computer or installed new hardware.
- Any programs that you have installed on the data acquisition computer.
- Other instruments connected to the data acquisition computer, like amplifiers, stimulators, temperature controllers.

The **Multi Channel Systems User Forum** provides the opportunity for you to exchange your experience or thoughts with other users worldwide.

If you have subscribed to the General Electrophysiology Mailing List, you will be automatically informed about new software releases, upcoming events, and other news on MCS products. You can subscribe to the list on the contact form of the MCS web site.

6.2 Error Messages

6.2.1 Computer Performance

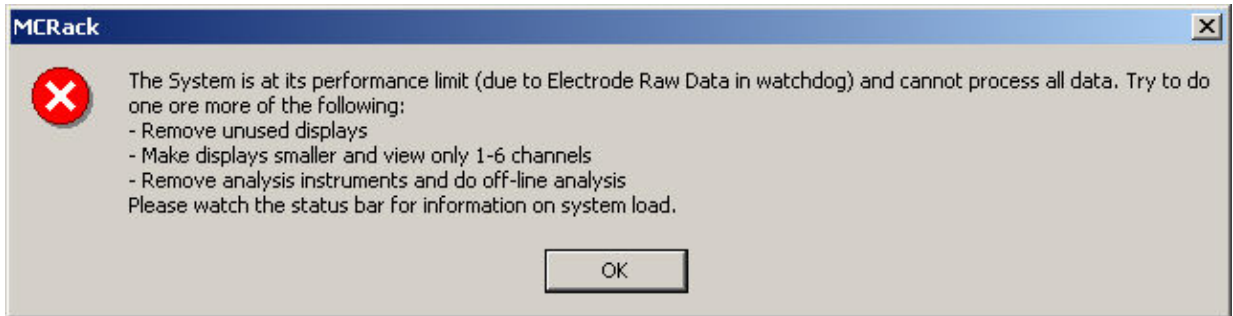

Performance limit messages occur if the computer performance does not support the current rack configuration. The more virtual instruments (especially displays and digital filters) you use, the higher is the CPU usage. Open the Windows Task Manager and watch the CPU usage. Try the following.

- Do not run any programs (especially no virus scanning program or firewall) in parallel on the data acquisition computer. Check that MC_Rack is the only active application in the Windows Task Manager. Close all other applications if not.
- Switch off the **Peak Detection** in the displays.
- Remove any unused virtual instruments or displays.
- Select only the channels of interest for recording and online analysis.
- Use a lower sampling rate. For most signals, 25 kHz is fine. For slower signals like field potentials or cardiac signals, you may even use lower sampling rates like 10 kHz.
- If you are using the spike detection feature in **Threshold** mode, check the spike detection level on all channels. If the threshold on a noisy but unattended (i. e. not shown in the **Spike Sorter** display) electrode is set too low, all the noise signals recorded by this electrode are detected as spikes and this will lead to a high CPU usage. Please remember that the display layout is independent from the electrodes that are selected for spike extraction.
- If this does not help, consider recording the raw data and doing offline analysis.
- Some Windows services are also known to cause performance limits or program instabilities. They were turned off by the manufacturer. You may want to confirm their status if you observe problems with unknown cause. Please see Installing MC_Rack for details.

6.2.2 Replayer

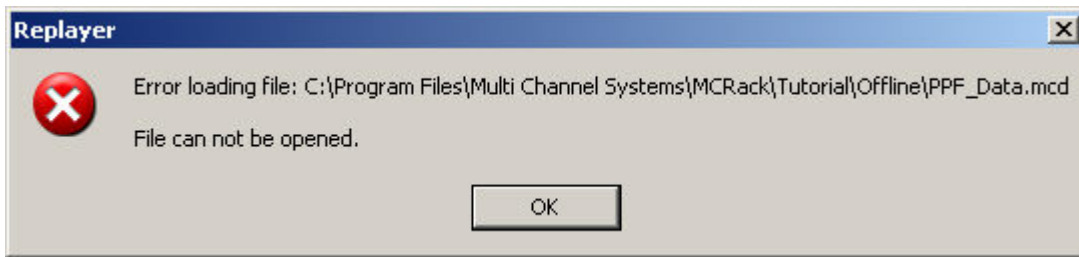

Occurs when a rack file is opened and the file path of the data file loaded into the **Replayer** is not valid. The **Open** dialog box will open automatically. Please select an appropriate data file (*.mcd) and click **Open**. The file name of the file that was loaded into the **Replayer** will be suggested to you.

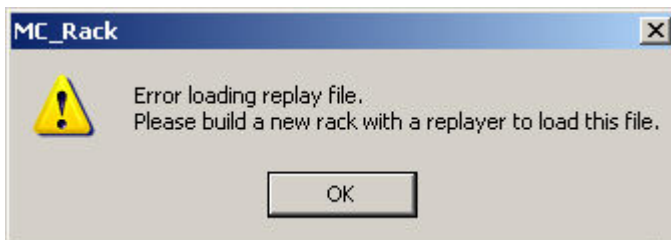

The data file that is linked to the **Replayer** in the current rack file is not compatible with the current rack configuration, for example, any channel is different or missing, or the data is triggered, but the rack was based on a continuous data file. This can happen when you overwrite or rename an existing data file, or when the file path of the data file loaded into the **Replayer** is not valid, and you open an incompatible data file instead of the original data file the rack was based on. Please create a new rack file, add a **Replayer** and load the desired data file again into the **Replayer**.

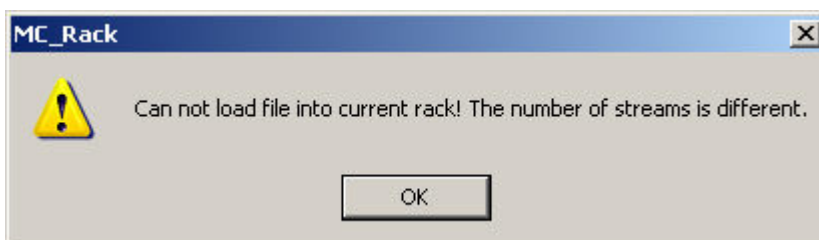

Occurs when you try to load an incompatible data file into the **Replayer** of an existing rack file. Please create a new rack file, add a **Replayer** and load the desired data file again into the **Replayer**.

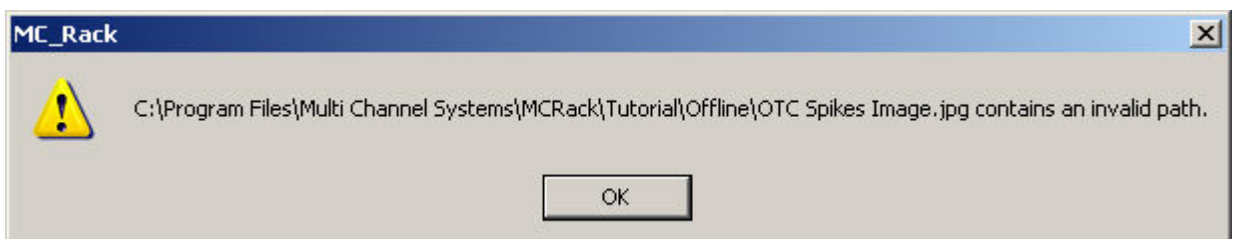

Occurs when a **Replayer** rack is opened. The data file that was loaded into the **Replayer** was recorded after loading a background picture. The linked image file was either removed, renamed, or moved to another folder after recording. You can ignore the error message, or restore the file path as given in the error message if you want to load the background picture automatically together with the data file

6.2.3 Recorder

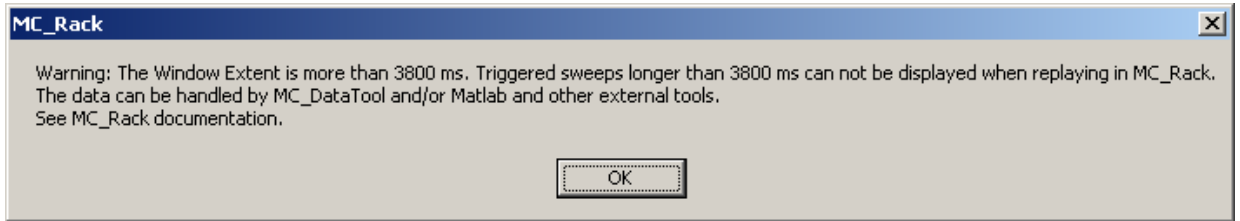

Occurs when the "Window Extent" setting in "Windows" tab of the **Recorder** is out of range. Please read chapter "Triggering MC_Rack on a Stimulus" for more information about "Window Extent" settings.

6.2.4 Running more than one instance of MC_Rack in parallel

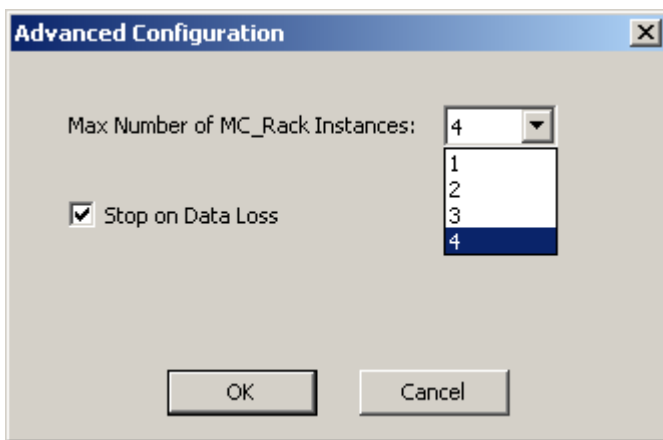

When using more than one instance of MC_Rack in parallel an error message will be displayed if the user tries to open more than the defined numbers of instances of MC_Rack.

6.2.5 Hardware Errors

Hardware error #5,
hardware error #6

An incompatible processor was installed onto the data acquisition computer. Please contact your local retailer for further assistance.

6.3 Data is not Written to Hard Disk

You started the recording by pressing the **Start** button. You see the recorded data in the MC_Rack displays, but no data is written to the hard disk.

Possible causes:

- ? The red **Record** button was not pressed in. MC_Rack was designed like a tape deck. You can start and stop the recording without writing data to the hard disk, for example, if you want to do some test recordings, or if you want to wait until the activity of the brain slice has reached the baseline level. Data files are generated **only** when the red **Record** button is activated.
1. Stop the recording.
 2. Make sure the red **Record** button is pressed in and start the recording again.

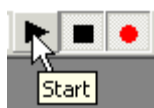

- ? The hard disk is full. MC_Rack may stop to respond in this case.
- Make a backup copy of the data files on your hard disk, and delete data on the disk until enough disk space is available before you restart the recording.
 - Empty the **Recycle Bin** of the Windows operating system on a regular basis.

6.4 Channels Not Visible or Available

Analog channels not visible in Data Display

An analog signal is applied to one of the additional analog inputs. You started the recording by pressing the Start button, but you do not see the analog raw data stream in the display.

Possible causes:

- ? The Analog Raw data stream was not selected for the display. The display graphs only the data streams that were assigned to it.
1. In the tree view pane of the virtual rack, select the Data Display.
 2. Click the Data tabbed page and select the Analog Raw data stream.
- ? The selected channel map does not support the analog channel of interest.

Similar to other virtual instruments in MC_Rack, displays do not recognize active channels by themselves, but you have to set up a channel map for each display separately. A channel map defines the layout in which the channels of a display appear, that is, information about the channel numbers and their positions. There are several standard maps provided in the MC_Rack program folder, for example the 8x8 MEA layout, but you can set up and save your own custom maps as well. That means, to display for example the additional analog channel A2, you need to set up a channel map that includes channel A2. Channel A1 is already preconfigured in the standard "8x8mea.cmp" channel map. For more information on how to set up a channel map, please see Setting Up a Display Layout in the MC_Rack Features section.

- ? The y-axis range is not suitable for the displayed data.

Signals on the analog channels are recorded "as is", with no respect to the gain specified in MC_Rack, as the true gain is generally completely different on the electrode inputs and on the additional analog inputs. Therefore, you generally need different y-axis ranges (and therefore separate displays) for seeing the data traces in an appropriate scale.

Only 64 channels of a 128 channel MC_Card available

After a new installation of MC_Rack or of the MC_Card, only the first 64 channels (or MEA A) are visible in the displays or on the channel selection pages of the virtual instruments, though the Hardware tabbed page of the MC_Card confirms 128 channels.

Possible causes:

? The data source setup was configured for a 64-channel system.

1. On the **Edit** menu, click **Data Source Setup**.

Configure the setup according to your hardware setup. For example, for a MEA 120-System, select 2 dim. (MEA). For more information on the data source setup, see Data Source Setup in the MC_Rack Features section.

? The selected channel map does not support the channels of interest.

Displays in MC_Rack do not recognize active channels by themselves, but you have to set up a channel map for each display separately. A channel map defines the layout in which the channels of a display appear, that is, information about the channel numbers and their positions. There are several standard maps provided in the MC_Rack program folder, for example the 8x8 MEA layout, but you can set up and save your own custom maps as well. That means, to display for example the electrode channels of the second MEA B, load the preconfigured channel map "8x8meaB.cmp". For more information on how to set up a channel map, please see "Setting Up a Display Layout" in the MC_Rack Features section.

7 Appendix

7.1 Contact Information

Local retailer

Please see the list of official MCS distributors on the MCS web site.

User forum

The Multi Channel Systems User Forum provides the opportunity for you to exchange your experience or thoughts with other users worldwide.

Mailing list

If you have subscribed to the Mailing List, you will be automatically informed about new software releases, upcoming events, and other news on the product line. You can subscribe to the list on the MCS web site.

www.multichannelsystems.com

8 Glossary

A

aliasing: Frequencies (noise) that are above half the sampling rate (for example above 2.5 kHz at a 5 kHz sampling rate) will be transformed into lower frequencies.

anti-aliasing: Using an analog Low Pass filter for removing high frequency noise, which would lead to aliasing if a sampling frequency lower than twice the bandwidth of the input signal is used.

B

Bandstop Resonator: In signal processing, a bandstop filter is a filter that passes most frequencies unaltered, but attenuates those in a specific range to very low levels. A bandstop filter with a high Q factor has a narrow stopband.

Bessel Filter: A Bessel filter is a type of linear filter with a maximally flat group delay (maximally linear phase response). Analog Bessel filters are characterized by almost constant group delay across the entire passband, thus preserving the wave shape of filtered signals in the passband.

bit: A bit is a binary digit, taking a value of either 0 or 1. The digital data stream of the MC_Card has 16 input and 16 output bits. A single bit can be used, for example, to trigger the recording (based on a TTL output of a stimulator) or an external device. Multiple bits can be used to set up more complex trigger patterns (where several requirements need to be met) or to encode a decimal number, for example, from an external measuring instrument. In a number, bits are always counted starting with 0, i. e. the 16 bits are numbered from 0 to 15.

Bitmap (BMP): Standard Windows bitmap image format, file extension *.bmp

Butterworth Filter: The Butterworth filter is one type of filter design. The frequency response of the Butterworth filter is maximally flat (has no ripples) in the passband, and rolls off towards zero in the stopband. For a second-order Butterworth filter, the response decreases at -12 dB per octave.

C

Chebyshev Filter: Chebyshev filters are analog or digital filters having a steeper roll-off than Butterworth filters. Chebyshev filters have the property that they minimize the error between the idealized filter characteristic and the actual over the range of the filter, but with ripples in the passband. Because of the passband ripple inherent in Chebyshev filters, filters which have a smoother response in the passband but a more irregular response in the stopband are preferred for some applications.

continuous recording: Opposite of triggered recording. Recording is started once and the data is saved continuously to the hard disk until the recording is stopped. Note that a triggered data analysis or display (online or offline) is possible independent of the recording mode.

D

Device Independent Bitmap (DIB): Windows clipboard format, file extension *.dib.

Digital Data: The Digital Data stream is the input data stream from the 16-bit digital input of the MC_Card. In a standard MEA- or ME-System, only three of the 16 digital input bits are available via BNC connectors. A digital in/out extension is available as an accessory for accessing all 16 input and output bits. The Digital Data stream can only have values of 0 and 1. It can be displayed with the Digital Data Display.

Downsampling: The downsampling feature offers the possibility to generate raw and filtered data streams with different sampling frequencies to avoid huge amounts of resulting data when recording more than one data stream.

E

Enhanced Meta File (EMF): Intermediate format for exchanging vector graphics data, file extension *.emf.

EPSP: Excitatory postsynaptic potential, an electrical change (depolarisation) in the membrane of a postsynaptic neuron caused by the binding of an excitatory neurotransmitter from a presynaptic cell to a postsynaptic receptor.

F

fEPSP: Field excitatory postsynaptic potential

G

Graphics Interchange Format (GIF): Indexed-color bitmap graphics, LZW-compressed format designed to minimize file size, binary transparency, file extension *.gif

H

High: Logical active state of a bit, also known as state 1 or On. For TTL pulses, a High state means a voltage level of usually 5 Volts.

high pass filter: A filter that passes high frequency waveforms. For example, a 300 Hz high pass filter passes spikes, but no LFPs.

I

ICO: Bitmap format used for Windows icons (in programs and on desktop), file extension *.ico.

J

Joint Photographic Experts Group (JPEG): Bitmap format, compressed by selectively discarding data, no transparency, file extension *.jpg.

L

LFP: Local Field Potentials are sum field potentials of the activity within a volume of tissue. The amplitude reflects the number of active neurons that are contributing to the LFP. In comparison with single spiking activity, it is a lower frequency signal. To obtain only LFPs (without single spikes), a 300 Hz low-pass filter can be used.

Low: Logical inactive state of a bit, also known as state 0 or Off. For TTL pulses, a Low state means 0 Volts.

low pass filter: A filter that passes low frequency waveforms. For example, a 300 Hz low pass filter passes LFPs, but no spikes.

lower cutoff frequency: Between the lower cutoff frequency and the upper cutoff frequency of a frequency band is the resonant frequency, at which the gain of the filter is at its maximum. Signal components with a lower frequency than the lower cutoff frequency of a band pass filter are attenuated.

LTD: Long Term Depression

LTP: Long Term Potentiation

M

MB (megabyte): One megabyte is equal to 1,048,576 bytes, or 1,024 kilobytes.

O

OTC: Organotypic Culture: An MEA experiment where the slice is cultured on the MEA for weeks or months, in contrast to an acute slice experiment.

P

peak-peak: Interval from maximum to minimum signal

PPD: Paired Pulse Depression

PPF: Paired Pulse Facilitation

R

Real-time Feedback: The real-time feature allows the user to generate TTL signals in response to defined signal patterns detected by one or several electrodes. These TTL signals in turn can control a stimulus generator (STG) to deliver feedback stimulation to the biological sample within a time frame of one millisecond after the actual event.

ROI: Region of interest: In triggered operation mode, the Analyzer extracts parameters from a user-defined region of interest.

S

Savitzky Golay Filter: The parameters of the Savitzky-Golay filter are the order (2 or 4) and the number of points which are included from the right and the left side of a data point for averaging the calculated data point (2, 4, 8, 16, 32, 48). This filter can be used to smooth a noisy signal. However, it is possible to accidentally filter out fast signals, like spikes, those in a specific range to very low levels. A bandstop filter with a high Q factor has a narrow stopband.

spike: A field potential that is the extracellular representation of an action potential. The spike rate reflects the intensity of activity. In comparison with LFPs, it is a higher frequency signal. To obtain only spikes (without LFPs), a 300 Hz high-pass filter can be used.

T

triggered recording: A non-continuous recording of cutouts around a trigger event, for example, for recording evoked responses. The cutout size is selected in the Recorder. Note that the data in-between the cutouts is lost permanently.

TTL: Transistor-Transistor Logic. Digital signal for communication between two devices. A voltage between 0 V and 0.8 V is considered as a logical state of 0 (LOW), and a voltage between 2 V and 5 V means a 1 (HIGH).

U

upper cutoff frequency: Between the lower cutoff frequency and the upper cutoff frequency of a frequency band is the resonant frequency, at which the gain of the filter is at its maximum. Signal components with a higher frequency than the upper cutoff frequency of a band pass filter are attenuated.

W

Windows Meta File (WMF): Intermediate exchange format for 16-bit Windows applications, limited vector graphics support, file extension *.wmf.

9 Index

1		
1-dimensional		
data source setup.....	73	
2		
2-dimensional		
data source setup.....	73	
A		
Add Digital Output	130	
Advanced Configuration	23	
Aliasing	154	
Analog Raw Data		
about	95	
additional analog channel	23	
averaging.....	185	
detecting triggers	125	
displaying	118	
filtering.....	146	
Plot Types (Data Display).....	118	
recording	102	
triggering on.....	127	
Analyzer		
about	172	
displaying parameters	178	
extracting parameters	173	
Maximum.....	173	
Minimum	173	
Number.....	173	
Parameter Display.....	178	
Peak to Peak Amplitude.....	173	
Rate	173	
Slope	173	
t-Max.....	173	
t-Min	173	
Analyzing		
spikes	193	
Anti-aliasing	154	
ASCII Export		
about	194	
ASCII export of displayed data.....	117	
exporting overlaid traces	118	
exporting parameter plots.....	184	
exporting raster plot.....	119	
exporting raw/analog data traces ..	118	
of parameter streams	194	
Audio Tool	187	
Automatic mode	108	
Automatic Trigger	129	
Average		
analyzing mean value in time window	173	
Averager data streams	95, 99	
Averager Trigger.....	185	
averaging sweeps.....	185	
Avg Trigger.....	99	
extracting the mean	173	
recording averaged data	99	
replaying averaged data.....	99	
B		
Background		
Background Picture	116	
change display background color ..	112	
Beating		
monitoring beating rhythm.....	178	
Bin		
bin size	177	
Binary		
binary data and code	101	
Bit		
binary data and code	101	
digital display.....	121	
numeric display.....	122	
triggering on input bits	125	
Black		
reverse background color	112	
Buffer Info	108	
Burst Analyzer	166	
Butterworth Low and High Pass filter	149	
C		
Capture	185	
Channel Tool	35, 91	
Channels		
Channel Layout (Hardware).....	73	
Channel Map (Display).....	111	
Channel Selection (Instruments).....	97	
MC_Card settings.....	88	
Color		
Color Maps.....	179	
Color vs. Time plot.....	180	
False Color plot.....	180	
Color vs. Time	180	
Configuration	9	
Coninuous		
Continuous Data.....	108	
recording.....	98	
Cool color map	179	
Create new file		
create new files on trigger	105	
creating data files.....	105	
Create new file on trigger	102	
Cutoff Frequency	146, 149	
D		
Data		
creating data files.....	105	
data file name and path	105	
data stream types	95	
replaying data.....	108	
Data Display		

MC_Rack Manual

Longterm Display.....	36	about.....	95
plot types.....	118	analyzing.....	172
settings.....	112	averaging.....	185
Data export.....	189	displaying.....	118
Data Source Setup		filtering.....	146
Configuration.....	9	recording.....	102
setting up the data source.....	73	spike detection.....	160
Simulation mode.....	93	spike sorting.....	165
Dead Time.....	164	triggering on.....	127
Decimal number.....	101, 122	Event	
Delay		analyzing event rate and interval.....	178
digital output.....	130	event based analysis.....	172
Detection		Event Marker.....	123
analyzing detection events.....	178	Exporting	
detecting spikes.....	160, 162, 163	about.....	189
detecting triggers.....	125	MC_DataTool.....	194
Digital channel		Extraction	
triggering on TTL pulses.....	125	of parameters of interest.....	172
Digital Data		F	
about.....	95, 101	False Color.....	179, 180
displaying.....	121	Feedback	
triggering on TTL pulses.....	125	digital output.....	130
Digital Display.....	121, 122	File	
Digital Output.....	130	data file location.....	105
Display		File Info.....	108
about.....	110	loading a data file.....	107
ASCII Export.....	118, 119	replaying data files.....	108
channel layout.....	111	reuse existing file in multiple instances of MC_Rack.....	23
Color vs. Time.....	180	saving a data file.....	102
custom display layout.....	36	Filter	
customizing display settings.....	115	about.....	146
Data Display.....	118	aliasing.....	154
decimal number.....	101, 121, 122	anti-aliasing.....	154
Digital Display.....	121, 122	filter types.....	149
exporting pictures.....	190	sampling rate.....	154
False Color.....	180	Filter Types.....	149
layout.....	36	Bandstop Resonator.....	149
loading a background picture.....	116	Bessel 2nd Order.....	149
Longterm Display.....	36	Bessel 4th Order.....	149
Number.....	181	Butterworth.....	149
Overlay.....	118	Chebyshev 2nd Order.....	149
Parameter Display.....	178	HighPass / Low Pass.....	149
parameter trace.....	179	Savitzky Golay.....	149
Peak Detection.....	114	Filtered Data	
Raster Plot.....	119	about.....	95
settings.....	112	analyzing.....	172
spike detection.....	165	displaying.....	118
spike sorting.....	165	filter types.....	149
Downsampling.....	156	filtering data.....	146
cutoff frequency.....	156	spike detection.....	160
high pass filter.....	156	spike sorting.....	165
low pass filter.....	156	triggering on.....	127
Nyquist-Shannon.....	154, 156	Frequency	
Driver		sampling.....	88
for MC_Card.....	4	G	

E

Electrode Raw Data

Graphs

for presentations.....	190	masking digital input bits.....	125
high resolution.....	191	Matlab	
Grouping		using MC_Rack files.....	191
Multitrode.....	93	Maximal sampling frequency	23
Guided Tour	7	Maximum	173
H		MC_Card	88
Hardware		data source setup.....	73
data source setup.....	73	triggering on TTL pulses.....	125
MC_Card settings.....	88	MC_DataTool	
High		about.....	194
high pass filter.....	149	MC_Rack	
logical state.....	101	multiple instances.....	23
I		ME-System	
Image		data source setup.....	73
background picture.....	116	MEA Layout	36
image capture.....	185	button.....	36
Input		custom MEA layout.....	36
bits.....	125	MEA Signal Generator	7
data streams.....	95	MEA-System	
voltage range.....	88	data source setup.....	73
Installation		MEA2100-System.....	33, 73, 88
of MC_Card.....	4	MEA2100	
of MC_Rack.....	4	Data Source Setup.....	54
Interspike Interval	178	Digital Channel Layout.....	54
Interval		Hardware Settings.....	54
automatic trigger.....	129	MEA2100-System.....	54
interspike or RR interval.....	178	Real-time Feedback.....	54
J		Stimulus Generator.....	54
Jet Color Map	180	MEA2100-32System	9
L		Mean	
Layout		extracting the mean.....	173
display layout.....	111	MEA-SG	7
Simulation mode.....	93	MEATools	
Level		using MC_Rack files.....	191
spike detection level.....	162	Minimum	173
trigger detection level for triggering		Multiple	
on a parameter.....	128	multiple instances of MC_Rack.....	23
trigger detection level for triggering		Multitrode	
on raw data.....	127	analysis.....	191
Linear fit	173	grouping channels.....	93
Loading		N	
data into MC_Rack.....	107	Negative Slope	
Load Image.....	116	trigger detection.....	127, 128
Logic	101	New	
Low		data files.....	105
logical state.....	101	Number	
Low Pass filter.....	149	extracted parameters.....	173
M		Number plot type.....	181
Manual Trigger	123	Numeric Display.....	122
continuous mode.....	123	of available channels.....	73
masking events manually.....	123	Nyquist-Shannon	154
Mask			

O

Offset
 defining a channel offset in channel maps for non-rectangular grids 111

Offset Correction 88

On Trigger 105

Oscilloscope
 Data Display 118
 Digital Display 121
 display types 110
 Parameter Display 178

Overlay Mode 118

P

Parameter
 extracting interspike or RR interval 178
 extracting signal rate 178
 triggering on a parameter 128

Parameter Display
 plot types 178
 trace plot 179

Parameters
 about 95
 Analyzer parameters 173
 extracting 172
 plotting 178

Peak Detection 114

Peak to Peak Amplitude 173

Periodic
 generating time based trigger events 129

Plot Types
 about 178
 Color vs. Time 180
 False Color 180
 Number Plot 181
 Overlay 118
 Raster Plot 119
 Trace 179

Positive Slope
 trigger detection 127, 128

Post Trigger
 of spike cutouts 164
 recording triggered data 102
 showing post-trigger times 112

Pre Trigger
 of spike cutouts 164
 recording triggered data 102
 showing pre-trigger times 112

R

Range
 of axes 112

Raster Plot 119

Rate
 analyzing signal rate 178

display refresh rate 112
 sampling 88
 spike rate 173

Raw Data 95

Real-time Feedback 131
 And / Or option 131
 Digital hardware filter 131
 DSP 131
 feedback logic 131
 feedback stimulation 131
 Spike detection 131

Record 102

Recording
 Auto Stop 105
 averaged data 99
 data in general 102
 Recorder settings 105
 Triggering Recorder 105

Refresh
 display refresh rate 112
 refreshing spike detector 162

Region of interest 172

Replaying data
 averaged data 99
 Replayer settings 108
 Replayer speed 108

Reset
 Replayer 108

Reverse Display 112

ROI 172

RR Interval 178

S

Sampling
 aliasing 154
 filtering 154
 rate 88

Sampling frequency 23, 88

Save
 saving averaged data 99
 saving data 102
 saving data to hard disk 105
 saving displayed data as ASCII 117
 saving parameters as ASCII 184

Savitzky-Golay filter 149

Screen shot 182, 185, 190

Several MEAs
 channel layout 111
 data source setup 73

Show Data Points 179

Show Image 116

Signal
 rate or interval 178

Simulation
 enabling simulation mode 93

File Source	93	Synchronize	
Sine Waves		recording.....	105
Simulation mode.....	93	SyncOut	125
Slope		T	
analyzing slope	173	Tetrodes	
spike detection (slope)	163	analysis.....	191
spike detection (threshold)	162	grouping channels.....	93
trigger detection.....	127	Threshold	
Snapshot	182, 185	spike detection	162
Sound	187	trigger detection	127
Spike Analyzer	178	Time bin	172
about	172	t-Max	173
Spikes		t-Min	173
about	95	Trace Plot	110, 118, 179
analyzing	193	Trigger	
analyzing spike rate or interspike		about.....	95
interval.....	178	averaging triggered sweeps	99, 185
analyzing spikes.....	173	creating new files.....	105
burst.....	166	digital output.....	130
exporting.....	191, 193	Manual Trigger.....	123
overlaying spikes.....	118	show pre-trigger times.....	112
Raster plot.....	119	stop recording on trigger	105
sorting.....	191	Trigger Detector	125
spike cutouts	164	trigger event list.....	129
spike detection.....	160	Triggered Data.....	98
spike sorting	165	Triggered recording	98
spikeform.....	165	triggering on biological signals.....	127
triggering on the spike rate.....	128	triggering on TTL pulses	125
Spreadsheet		Triggered recorder	102
exporting data	194	create new file on trigger.....	102
exporting parameters.....	194	stop on trigger.....	102
Start		TTL	
on a trigger	127	digital output.....	130
recording on trigger	105	triggering on TTL pulses	125
Start and End on Trigger.....	98	U	
Start on Trigger.....	98	Unload Image	116
start time for triggered data.....	98	USB	
start time of replayer.....	108	data acquisition	73
Statistics		USB-ME128-System.....	9
analyzing statistical parameters	172	USB-ME16-FAI-System	9
Step		USB-ME256-System.....	9
Single stepping through data file..	108	USB-ME32-FAI-System	9
Stereotrodes	93	USB-ME64-System.....	9
STG		USB-MEA256-System	9, 23
internal STG of MEA2100-System	88	Wireless System.....	70
Stimulation	88	V	
Stop		View	
Stop On Trigger.....	105	Data Display.....	118
Stop Time.....	98	Digital Display.....	121
stopping recording on trigger	105	Longterm Display.....	36
Stop on trigger	102	Parameter Display.....	178
Sweeps		Voltage	
averaging.....	185	range	88
overlaying.....	118	W	
Raster plot.....	119		
sweep number.....	108		

MC_Rack Manual

<i>W8-System</i>	33, 73	<i>time window</i>	98, 173
<i>Wait</i>		<i>Window Extent</i>	47, 98
<i>automatic trigger</i>	129	<i>Wireless Recording System</i>	33, 73
<i>White</i>		<i>Wireless System</i>	
<i>display background color</i>	112	<i>Wireless System W4</i>	70
<i>Window</i>		<i>Wireless System W8</i>	70
<i>spike sorting</i>	165		

