

multichannel*
systems

**MEA Amplifier
for Upright Microscopes
Manual**



Information in this document is subject to change without notice.

No part of this document may be reproduced or transmitted without the express written permission of Multi Channel Systems MCS GmbH.

While every precaution has been taken in the preparation of this document, the publisher and the author assume no responsibility for errors or omissions, or for damages resulting from the use of information contained in this document or from the use of programs and source code that may accompany it. In no event shall the publisher and the author be liable for any loss of profit or any other commercial damage caused or alleged to have been caused directly or indirectly by this document.

© 2020 Multi Channel Systems MCS GmbH. All rights reserved.

Printed: 06. 11. 2012

Multi Channel Systems

MCS GmbH

Aspenhastraße 21

72770 Reutlingen

Germany

Phone +49-71 21-90 92 5 - 0

Fax +49-71 21-90 92 5 -11

sales@multichannelsystems.com

www.multichannelsystems.com

Microsoft and Windows are registered trademarks of Microsoft Corporation. Products that are referred to in this document may be either trademarks and / or registered trademarks of their respective holders and should be noted as such. The publisher and the author make no claim to these trademark.

Table of Contents

Introduction	1
About this Manual	1
Important Information and Instructions	3
Operator's Obligations	3
Guarantee and Liability	3
Important Safety Advice	4
First Use of the MEA Amplifier	5
Welcome to the MEA Amplifier	5
Setting Up and Connecting the MEA Amplifier	6
First Tests and Tutorial	7
First Functional Tests	7
General Performance / Noise Level	7
Operating the MEA Amplifier	9
Signal Amplification and Filters	9
Temperature Control	10
Mounting the MEA Probe and Grounding the Bath	11
Stimulation	13
Service and Maintenance	13
Troubleshooting	15
About Troubleshooting	15
Noise on Single Electrodes	15
Unsteady Baseline	16
Artifacts on All Channels	17
Liquid Spilled onto Amplifier	18
Technical Support	18
Appendix	19
Technical Specifications	19
Pin and MEA Layout	19
MEA1060-Up	21
Heating Element	21
Test Model Probe	22
Contact Information	22
Ordering Information	23
Index	29

1 Introduction

1.1 About this Manual

This manual comprises all important information about the first installation of the hardware and software, and about the daily work with the instrument. It is assumed that you have already a basic understanding of technical and software terms. No special skills are required to read this manual.

If you are using the device for the first time, please read the **important safety advice** before **installing the hardware** and **software**, where you will find important information about the installation and first steps.

The **printed manual** and **Help** are basically the same, so it is up to you which one you will use. The Help offers you the advantage of scrolling through the text in a non-linear fashion, picking up all information you need, especially if you use the **Index**, and the **Search** function.. If you are going to read larger text passages, however, you may prefer the printed manual.

The device and the software are part of an ongoing developmental process. Please understand that the provided documentation is not always up to date. The **latest information** can be found in the **Help**. Check also the MCS web site (www.multichannelsystems.com) for downloading up-to-date manuals and Help files.

2 Important Information and Instructions

2.1 Operator's Obligations

The operator is obliged to allow only persons to work on the device, who

- are familiar with the safety at work and accident prevention regulations and have been instructed how to use the device;
- are professionally qualified or have specialist knowledge and training and have received instruction in the use of the device;
- have read and understood the chapter on safety and the warning instructions in this manual and confirmed this with their signature.

It must be monitored at regular intervals that the operating personnel are working safely.

Personnel still undergoing training may only work on the device under the supervision of an experienced person.

2.2 Guarantee and Liability

The *General conditions of sale and delivery* of Multi Channel Systems MCS GmbH always apply. The operator will receive these no later than on conclusion of the contract.

Multi Channel Systems MCS GmbH makes no guarantee as to the accuracy of any and all tests and data generated by the use of the device or the software. It is up to the user to use good laboratory practice to establish the validity of his findings.

Guarantee and liability claims in the event of injury or material damage are excluded when they are the result of one of the following.

- Improper use of the device.
- Improper installation, commissioning, operation or maintenance of the device.
- Operating the device when the safety and protective devices are defective and/or inoperable.
- Non-observance of the instructions in the manual with regard to transport, storage, installation, commissioning, operation or maintenance of the device.
- Unauthorized structural alterations to the device.
- Unauthorized modifications to the system settings.
- Inadequate monitoring of device components subject to wear.
- Improperly executed and unauthorized repairs.
- Unauthorized opening of the device or its components.
- Catastrophic events due to the effect of foreign bodies or acts of God.

2.3 Important Safety Advice



Warning: Make sure to read the following advice prior to install or to use the device and the software. If you do not fulfill all requirements stated below, this may lead to malfunctions or breakage of connected hardware, or even fatal injuries.



Warning: Obey always the rules of local regulations and laws. Only qualified personnel should be allowed to perform laboratory work. Work according to good laboratory practice to obtain best results and to minimize risks.

The product has been built to the state of the art and in accordance with recognized safety engineering rules. The device may only

- be used for its **intended purpose**;
- be used when in a **perfect condition**.
- Improper use could lead to serious, even fatal injuries to the user or third parties and damage to the device itself or other material damage.



Warning: The device and the software are **not** intended for medical uses and **must not** be used on humans.

Malfunctions which could impair safety should be rectified immediately.

High Voltage

Electrical cords must be properly laid and installed. The length and quality of the cords must be in accordance with local provisions.

Only qualified technicians may work on the electrical system. It is essential that the accident prevention regulations and those of the employers' liability associations are observed.

- Each time before starting up, make sure that the **mains supply** agrees with the specifications of the product.
- Check the **power cord** for damage each time the site is changed. Damaged power cords should be replaced immediately and may never be reused.
- Check the **leads** for damage. Damaged leads should be replaced immediately and may never be reused.
- Do not try to insert anything sharp or metallic into the vents or the case.
- Liquids may cause short circuits or other damage. Keep the device and the power cords always **dry**. Do **not** handle it with wet hands.

Requirements for the installation

- Make sure that the device is not exposed to direct sunlight. Do not place anything on top of the device, and do not place it on top of another heat producing device. Never cover the device, not even partially, so that the air can circulate freely. Otherwise, the device may overheat.
- Use and keep the device only in a dry environment. Fluids or damp air may damage or destroy the device. Spilled liquid can damage or even completely destroy the electronics of the MEA amplifier. Avoid it by all means.



Warning: The device must not get in contact with fluids! Spilled liquid can damage or even completely destroy the electronics of the amplifier! This is eminently important when using a perfusion system. Take care that the flow rates of the inlet and outlet flow match so that flooding of the amplifier is efficiently prevented.

3 First Use of the MEA Amplifier

3.1 Welcome to the MEA Amplifier

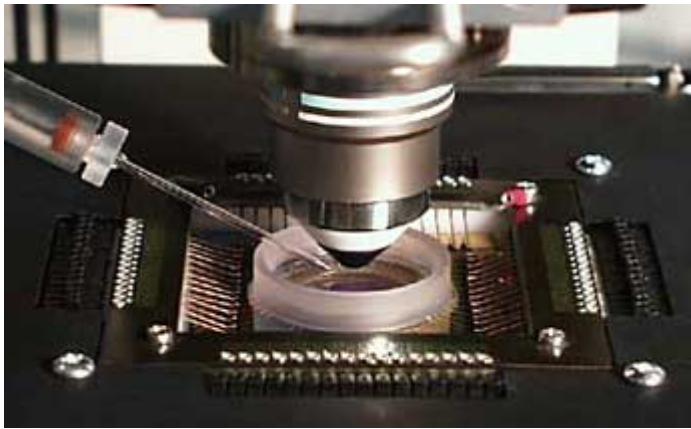

Raw data from up to **60 electrodes** of a **microelectrode array (MEA)** is amplified by **60 channels** of **filter amplifiers** that are built very small and compact using SMD (Surface Mounted Devices) technology. The small-sized MEA amplifier combines the **interface** to the **MEA probe** with the **signal filtering** and the **amplification** of the signal. The compact design reduces line pick up and keeps the noise level down.

The **MEA sensor** is placed directly into the small-sized MEA **amplifier**. When the amplifier is closed, the **contact pins** in the lid of the amplifier are pressed onto the MEA **contact pads**. The very close location of the amplifier to the MEA sensor is very favorable concerning a high signal-to-noise ratio.

MEA amplifiers can be ordered with different **gain** and **bandwidth** configurations by the user's choice. For example, typical pass bands would be 1 to 300 Hz for recording field potentials and 300 to 3000 Hz for recording action potentials. It is also possible to use a broadband amplifier and filter the data with the digital filter of the free MC_Rack program. Gain settings from 100 to 5000 are possible.

The amplifier is connected to the **data acquisition** computer via a single **68-pin MCS standard cable**. The analog output signals of the MEA amplifier are then acquired and digitized by the MC_Card (MEA-System) or your custom data acquisition system.

MEA amplifiers have an **integrated heating system** for controlling the **MEA's temperature**. The desired temperature can be easily programmed with a temperature controller. You will not need an incubator during recording all environmental conditions are reliably controlled directly in the MEA dish.

You can then simply **ground** bad or unwanted electrodes by toggling small switches on the amplifier. You can also connect a stimulus generator to any electrode(s) for **stimulation**. Amplifier inputs are grounded during stimulation to prevent a saturation of the amplifier.

3.2 Setting Up and Connecting the MEA Amplifier



Warning: Spilled liquid can damage or even completely destroy the electronics of the MEA amplifier. Please be extremely careful when setting up your perfusion system and when starting the perfusion. Take care that the flow rates of the inlet and outlet flow match so that flooding of the amplifier is efficiently prevented.

Note: The housing of the MEA amplifiers was optimized for Zeiss Axiovert microscopes. MEA amplifiers are compatible to most standard microscopes if the following prerequisites are met. This MEA amplifier type has been developed for standard upright microscopes with a rectangular microscope table. The focal plane of the microscope has to be in a distance of 8 mm to the microscope table.

Note: If you use a complete MEA-System, the MEA amplifier will usually be powered by the isolated power supply (IPS10W) that is integrated into the data acquisition computer. The power is distributed along the MCS 68-pin MCS high grade cable. If you use your MEA amplifiers together with a MEA Switch, or if you use a custom data acquisition system **without** IPS10W, you will need an **external power supply** for operating the amplifier(s). Please ask your local retailer for more information on setup options.

Note: If you use an USB-ME-System you need an **external power supply**, for example a PS40W, for operating the amplifier(s). Please ask your local retailer for more information on setup options.

Using the MC_Card for data acquisition: Connect the MEA amplifier's **output** to the MC_Card input labeled MC_Card Ch. 01–64 with a 68-pin MCS standard cable. If you have a MEA120-System, connect the second MEA amplifier with a 68-pin MCS standard cable to the input for channels 65–128 labeled MC_CX64 Ch. 65–128. If you are using a MEA Switch, connect the amplifiers to the MEA Switch inputs, and the MEA Switch outputs to the MC_Card.

Using an USB-ME data acquisition device: Connect the MEA amplifier's **output** to the USB-ME input via 68-pin MCS standard cable. If you are using a MEA Switch, connect the amplifiers to the MEA Switch inputs, and the MEA Switch outputs to the USB-ME device.

1. Place the MEA amplifier onto the microscope table.
2. Connect the internal heating element to a Temperature Controller's output channel (D-Sub9 socket) with the black cable. (The Temperature Controller is not part of the standard scope of delivery, but is included in the MEA-System or USB-ME-System, and can also be ordered separately.) Do **not** connect the black heating element cable to the data acquisition computer.
3. You should use a Faraday cage or appropriate materials, for example aluminum foil, for shielding the amplifier. The shielding should be connected to the amplifier's ground, for example, to the screws of the cover.

Please see also the separate handout "MEA Microelectrode Systems" for setup suggestions with detailed illustrations.

4 First Tests and Tutorial

4.1 First Functional Tests

Each MEA amplifier has been thoroughly tested at the factory site before delivery. However, you may want to perform some tests yourself before you begin your experiment to exclude any damage that might have occurred during transportation, or to fulfill your own guidelines, for instance.

Some of the tests will also help you to get to know the basic functions of the hard- and software, like a short tutorial. It will take only a few minutes time and can save you time and trouble in the long run. Multi Channel Systems MCS GmbH recommends running these tests after the setup of your system before you start your real experiments.

4.2 General Performance / Noise Level

Please use the provided model test probe to test the amplifier immediately after installation. The test model probe is already mounted on the amplifier. It simulates a MEA with a resistor of 220 k Ω and a 1 nF capacitor between bath and electrode. Use MC_Rack or your custom data acquisition program to record from the test model probe and to check the amplifier.

Setting up MC_Rack

Please refer to the MC_Rack manual for more information.

1. Start MC_Rack.
2. Open the file **MEA_Display.rck** on the installation volume. This basic rack contains the virtual **MC_Card** instrument with appropriate gain settings and a continuous raw data display.

- OR - Set up the rack on your own:

1. Click **Set Channel Layout** on the **Edit** menu. Select a 2-dimensional (MEA) layout or Configuration.
2. Add an **USB-MEA** device or the **MC_Card** to your virtual rack.
3. Click the **Hardware** tab of the USB-MEA device or the **MC_Card** and enter the amplifier gain (standard: 1200).
4. On the **Edit** menu, click **Add Data Display** to add a raw data display to your virtual rack.

Starting the recording

1. On the **Measurement** menu, click **Start** to start the recording. You see the raw data streams of all 60 channels in the typical MEA layout.
2. You may have to **adjust** the **position** and **span** of the **axes** until you can clearly see the noise level.

You should see the baseline with a maximum noise level of +/- 8 μ V.

MEA Amplifier for Upright Microscopes - Manual

The following screen shot shows a recording from a typical MEA amplifier with a test model probe and a sampling rate of 25 kHz.

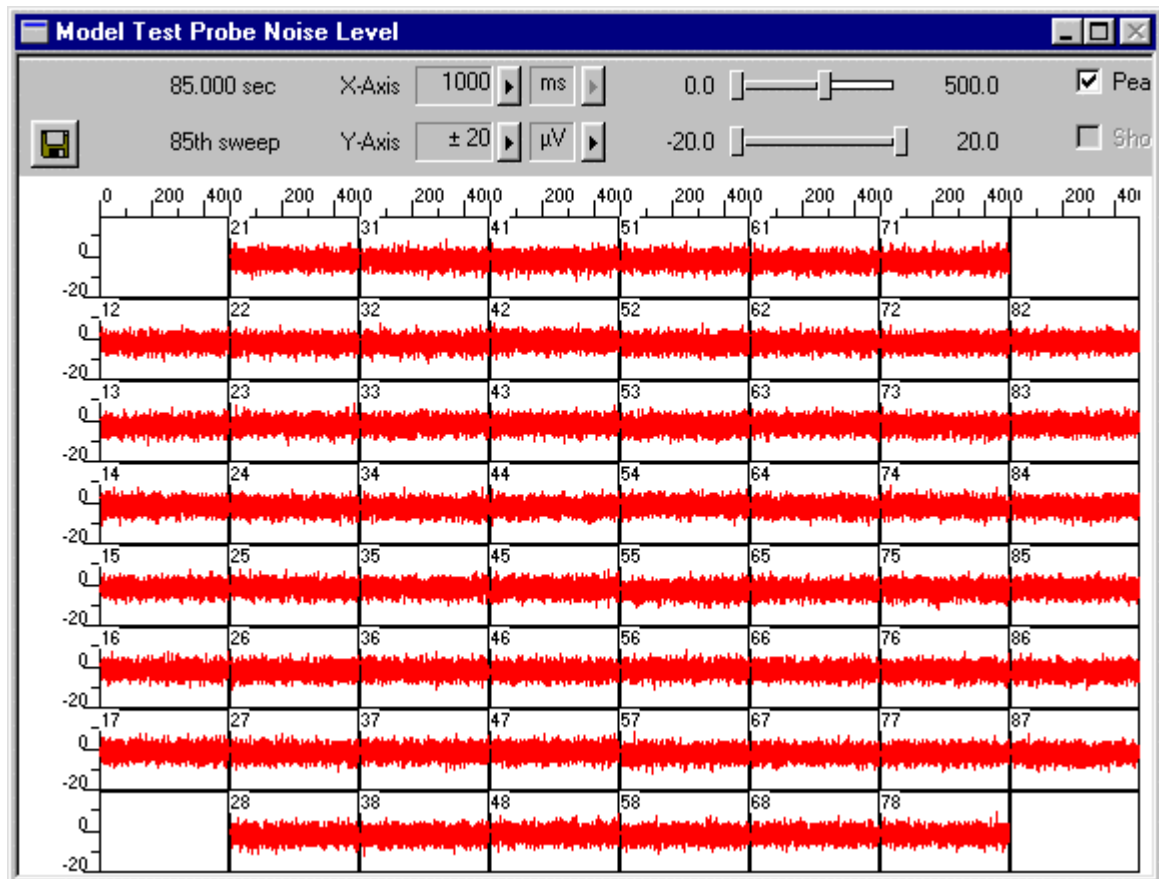

→ Double-click a channel in the display to have a closer look.

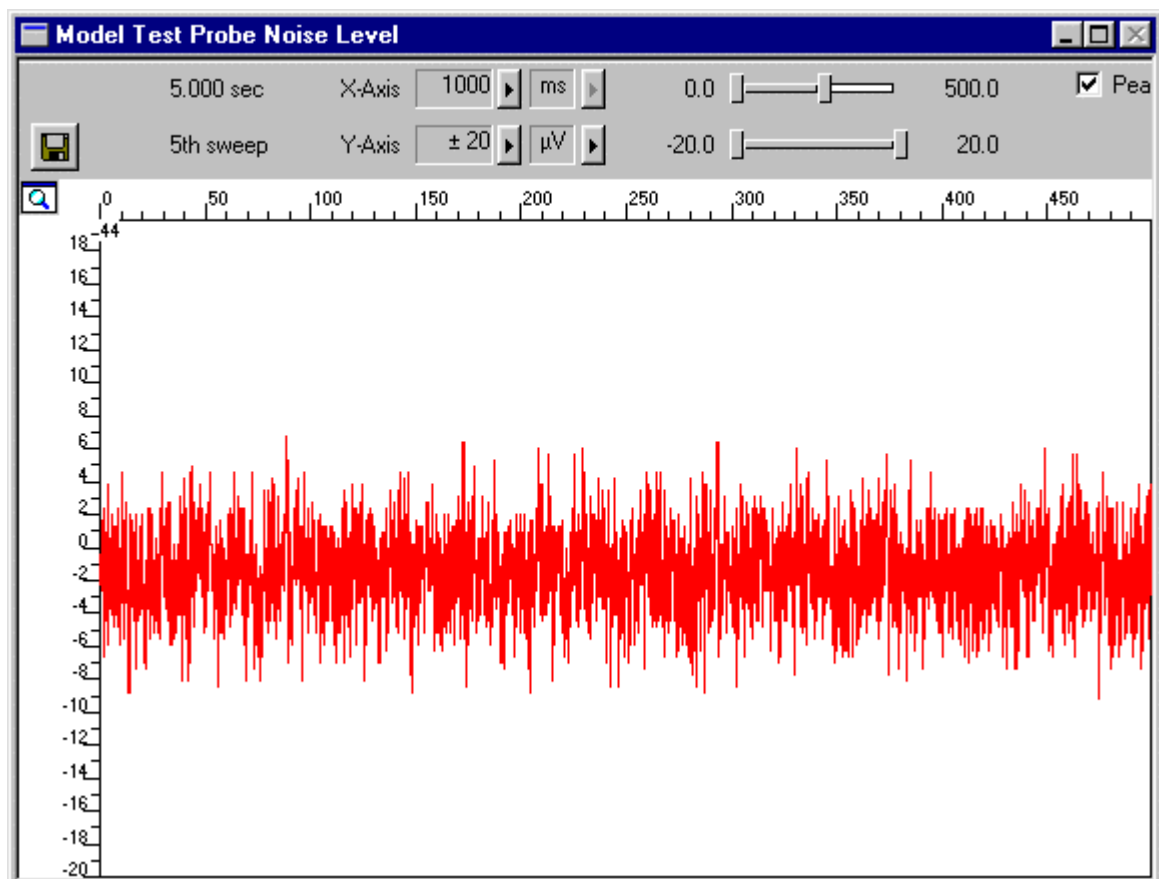

5 Operating the MEA Amplifier

5.1 Signal Amplification and Filters

The standard MEA amplifier combines the **probe interface** with a **band pass filter** and the **signal amplification** in one instrument.

Different filter settings are used for different applications to enhance the signal-to-noise ratio. The pass band of the filter amplifier should be chosen according to the signal type. It is generally useful to set the upper limit of the amplifier near the highest expected signal frequency, but also at a safe distance to make sure that the full gain is used for signal amplification.

For slow signals like field potentials, a bandwidth of 1 to 300 Hz is appropriate. If you like to record fast signals like spikes, a pass band of 300 Hz to 3 kHz is suitable. Cardiac signals have fast and slow components; therefore, you usually need a wider bandwidth of 1 Hz to 3 kHz.

Multi Channel Systems provides custom amplifiers with a bandwidth of your choice, from 0.1 Hz to 10 kHz. Please note that it is often useful to acquire the data with a broadband amplifier and use the digital filter of the free MC_Rack program to change the pass band and filter the raw data. This way, you are much more flexible in designing your experiments. As a further advantage, you can see the original (not filtered) data as well. This is especially important because all filters are known to distort signals. On the other hand, you may need a higher sampling rate to avoid aliasing, and you will have a lower signal to noise ratio.

The standard gain of a MEA amplifier is 1200 (1100 in case of a MEA amplifier with blanking circuit), which is fine for most applications, but MCS can also provide amplifiers with a gain of your choice (from 100 to 5000) as well. For large signals (for example, from whole-heart preparations), you need a lower gain to prevent a saturation of the amplifier. Please note that the gain is a fixed hardware property; and that you cannot change the gain of the amplifier by software controls. For more information on the technical specifications of your amplifier, please see the separate data sheet that is delivered with each amplifier.

Please note that the ratio of the output signal to the input signal, that is, the gain, is not a fixed parameter for the complete bandwidth. The gain that was specified for the amplifier, for example, 1200, is not fully reached at the borders of the amplifier's pass band. The general rule is, that at the lower and upper limit of the frequency band, the gain is $\sqrt{2}/2$, that is approximately 70 %, of the full gain. Therefore, you should use a bandwidth that is at a safe distance of the signals of interest. Outside the pass band, the gain decreases with the frequency and finally approaches zero.

The following illustration shows a typical frequency band of the MEA amplifier with standard gain and bandwidth (in blue). Output signal amplitudes were divided by the input signal amplitude and the resulting gain was plotted versus the input signal frequency on a logarithmic scale. A straight line at approximately 70 % of the specified gain intersects the plotted curve at the lower and upper limit of the pass band. The low-pass filter property of the combined MEA1060 amplifier and MC_Card (in black) is only slightly different.

For information on the gain and filters of the MC_Card data acquisition system, please see the ME- / MEA-System Manual. For more information on gain and filters in general, please refer to standard literature or contact your local retailer.

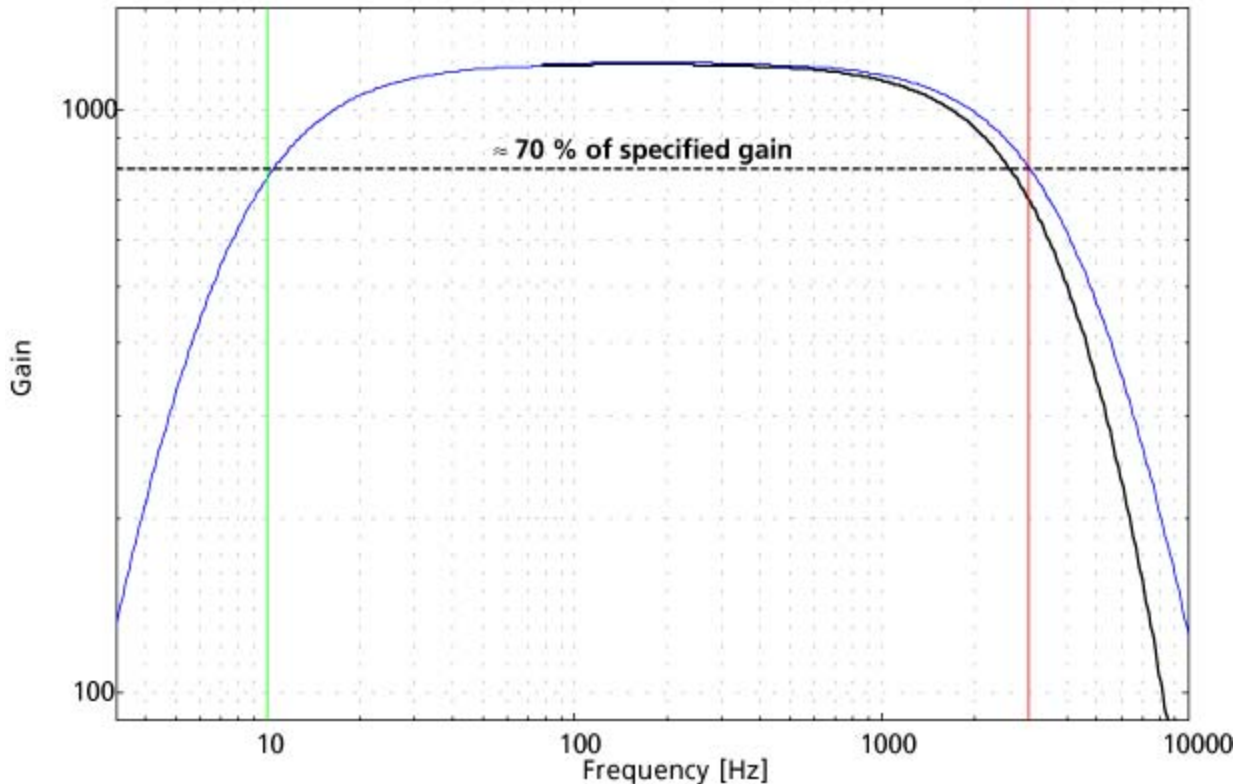

If you use a MEA-System, the isolated power supply IPS10W that is integrated in the data acquisition computer supplies the power for operating the MEA amplifier. The power is distributed along the MCS high grade cable. Please consider that the amplifier can only operate properly if the supply voltage and current specifications are fulfilled, especially if you use a custom power supply. See also the Technical Specifications and the Troubleshooting section.

5.2 Temperature Control

The biological sample is cultured directly on the MEA. You can record without needing an incubator, because a heating element is integrated into the amplifier and the perfusion cannula and are both controlled by a Temperature Controller (Temperature Controller and perfusion cannula with heating element and sensor are either included in the MEA-System or can be ordered separately). You have several options regarding the culture chamber, such as a semipermeable seal that guarantees stable environmental conditions.

For using the integrated heating element of the MEA amplifier, connect it with the black cable to the Temperature Controller. The heating is active, but the cooling is passive. Therefore, the minimum temperature is limited by the room temperature. Please refer to the Temperature Controller Manual for more information.

Important: Please make sure that you have selected the appropriate PID coefficients for the amplifier type (for inverted or upright microscopes) in use.

5.3 Mounting the MEA Probe and Grounding the Bath



Warning: Do not use too much force. Otherwise you could damage the delicate MEA chip or the contact pins of the amplifier.

Mounting the MEA Probe

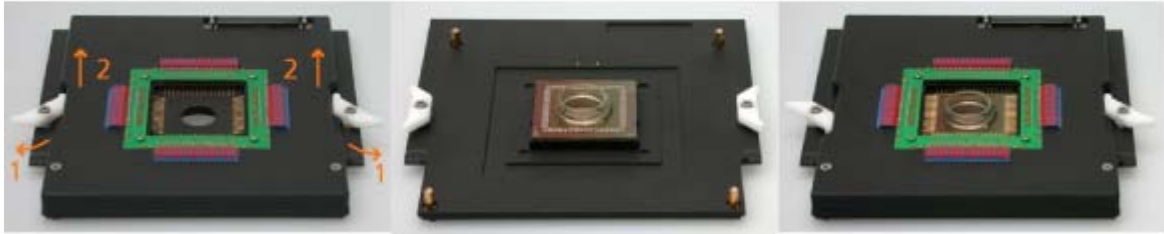

1. Place the MEA amplifier as shown on the photo. Click "Change MEA" in MEA_Select program. Open the lid of the MEA amplifier.
2. Place the MEA probe inside.

Important: MEA chips are not symmetrical! That is, why the **writing (NMI)** on the MEA chip should be on the right side and the reference electrode – if available – should be on the left side. Otherwise, the MEA layout will not match with the pin layout of the channel map in MC_Rack. This is very important for MEAs with internal reference electrode, for example.

3. Replace the lid and close it carefully. Do not unpress the "Change MEA" button until you have grounded the bath and replaced the shielding, that is, until the setup has been completely finished.



Warning: Spilled liquid can damage or even completely destroy the electronics of the MEA amplifier. Please be careful when setting up your perfusion system and when starting the perfusion. Take care that the flow rates of the inlet and outlet flow match so that flooding of the amplifier is efficiently prevented.

Grounding the bath

You can ground the bath with a plain silver wire or with an Ag/AgCl pellet. Only the Ag/AgCl electrode provides a stable intrinsic potential. In practice, the plain silver wire will be good for 90 % of applications. If you do not achieve satisfying results with the plain silver wire, try an Ag/AgCl electrode.

If you use MEAs with internal reference electrode, you can use the reference electrode for grounding the bath. This has the advantage that you can keep the culture chamber closed and sterile (for example, with MEA-MEM semipermeable membranes).

Important: If you use a MEA with internal reference electrode, you have to connect pin 15 to ground with the provided cable. Setting electrode 15 to ground in the MEA_Select program is not sufficient for grounding the bath.

1. Attach the provided **silver wire** or **pellet** to the amplifier's **ground** and place it into the **bath**, near the rim of the culture chamber. If you use a MEA with **internal reference electrode**, connect the ground to the **reference electrode socket (pin 15)** with the provided connector. Make sure that the orientation of the MEA inside the amplifier is appropriate.

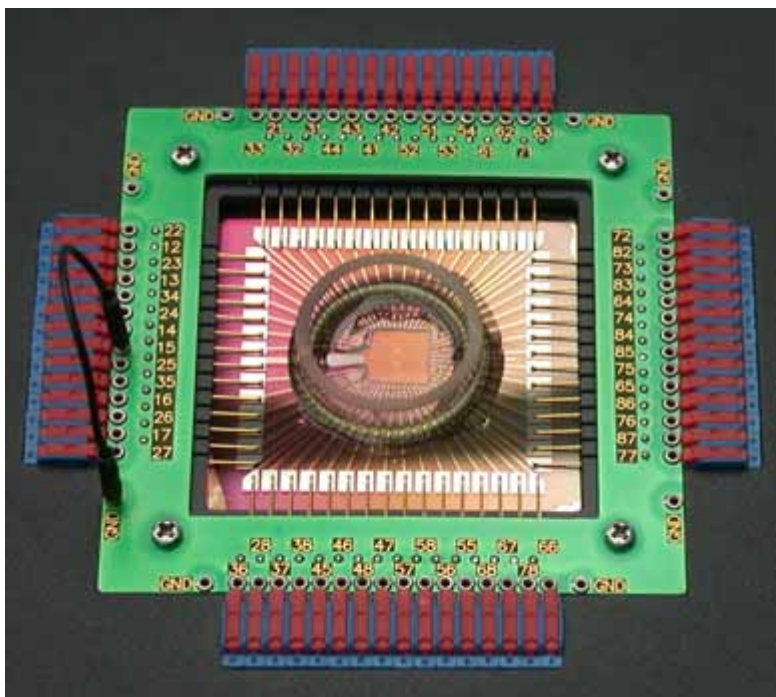

2. Replace the shielding.

5.4 Stimulation

Recommended stimulus protocols for MEA electrodes

MCS recommends to use biphasic pulses only, with negative phase first. The duration of the phases should be 100 μ s each and the amplitude 100 mV to 3000 mV. (See also Potter, S. M., Wagenaar, D. A. and DeMarse, T. B. (2005). Closing the Loop: Stimulation Feedback Systems for Embodied MEA Cultures. *Advances in Network Electrophysiology Using Multi-Electrode Arrays*. M. Taketani and M. Baudry, Springer; Wagenaar, D. A., Madhavan, R., Pine, J. and Potter, S. M. (2005). "Controlling bursting in cortical cultures with closed-loop multi-electrode stimulation." *J Neurosci* 25(3): 680-8.)

Stimulation with MEA electrodes

You can use any MEA electrode for stimulation. Simply connect the output channel(s) of your stimulus generator to the input socket(s) of any desired electrode(s).

You should use the slide switches for disconnecting stimulating electrodes from the amplifier.

Switch positions during recording and stimulation

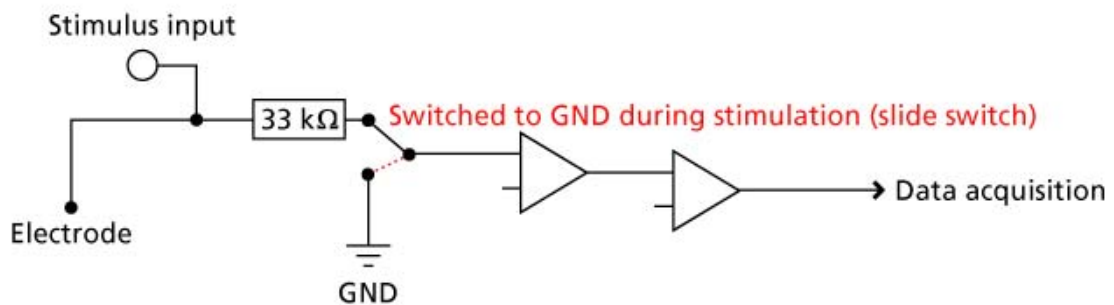

5.5 Service and Maintenance

You should clean the contact pins of the amplifier with a soft tissue and pure (100 %) alcohol from time to time, especially if you have problems with the noise level.

6 Troubleshooting

6.1 About Troubleshooting

The following hints are provided to solve special problems that have been reported by users. Most problems occur seldom and only under specific circumstances. Please check the mentioned possible causes carefully when you have any trouble with the product. In most cases, it is only a minor problem that can be easily avoided or solved.

If the problem persists, please contact your local retailer. The highly qualified staff will be glad to help you. Please inform your local retailer as well, if other problems that are not mentioned in this documentation occur, even if you have solved the problem on your own. This helps other users, and it helps MCS to optimize the instrument and the documentation.

Please pay attention to the safety and service information (chapter "Important Safety Advice" and "Service and Maintenance" in the Manual / Help). Multi Channel Systems has put all effort into making the product fully stable and reliable, but like all high-performance products, it has to be handled with care.

6.2 Noise on Single Electrodes

The noise level on single electrodes is significantly higher than $\pm 8 \mu\text{V}$.

Possible causes:

- ? The electrode or the contact pin of the amplifier may be defective. To test this, do the following.
 1. Open the amplifier and turn the MEA by 90 degrees.
 2. Close the amplifier again and start the recording.
If the same electrode in the MEA layout is affected, the amplifier's contact is not ok. If another electrode is now affected and the previously affected electrode is ok now, the MEA electrode is not ok, but the amplifier is fine.

- OR -

Use the test model probe to test the amplifier.

MEA electrode is defective

See also the MEA Manual.

Possible causes:

- ? The contact pads are contaminated.
 - Clean the contact pads carefully with a swab and pure (100 %) alcohol.
- ? The contact pads or the electrodes are damaged.
 - Use a new MEA. Try to handle and clean the MEA more carefully next time.

Contact pin is defective

Possible causes:

- ? The contact pins are contaminated.
- Clean the contact pins carefully with a smooth and clean tissue and pure (100 %) alcohol.
- ? The contact pins are damaged.
- Replace the contact pins carefully. Please see the Spare Parts list under "Ordering Information". Try to handle and clean the contact pins more carefully next time.

6.3 Unsteady Baseline

The baseline is unstable, signals are jumping or drifting.

Possible causes:

- ? Bath electrode is not connected to ground.
- Connect the internal or external bath electrode to one of the ground inputs of the amplifier as described in "Mounting the MEA Probe".
- ? AgCl bath electrode needs is not well-chlorided.
- Rechloride the electrode or use a new one.
- ? The MEA has an internal reference electrode and pin 15 is connected to ground appropriately, but the orientation of the MEA inside the amplifier is wrong. In this case, the wrong (standard size for recording) electrode is connected to ground, but not the reference electrode.
- Open the amplifier and check the orientation of the MEA and the reference electrodes described in "Mounting the MEA Probe".

6.4 Artifacts on All Channels

You see strange artifacts on all channels. This behavior can be caused by an insufficient supply power. Please see the Technical Specifications section. If the voltage drops beyond a critical level, the amplifier cannot operate properly, resulting in artifacts or in a saturation of the amplifier.

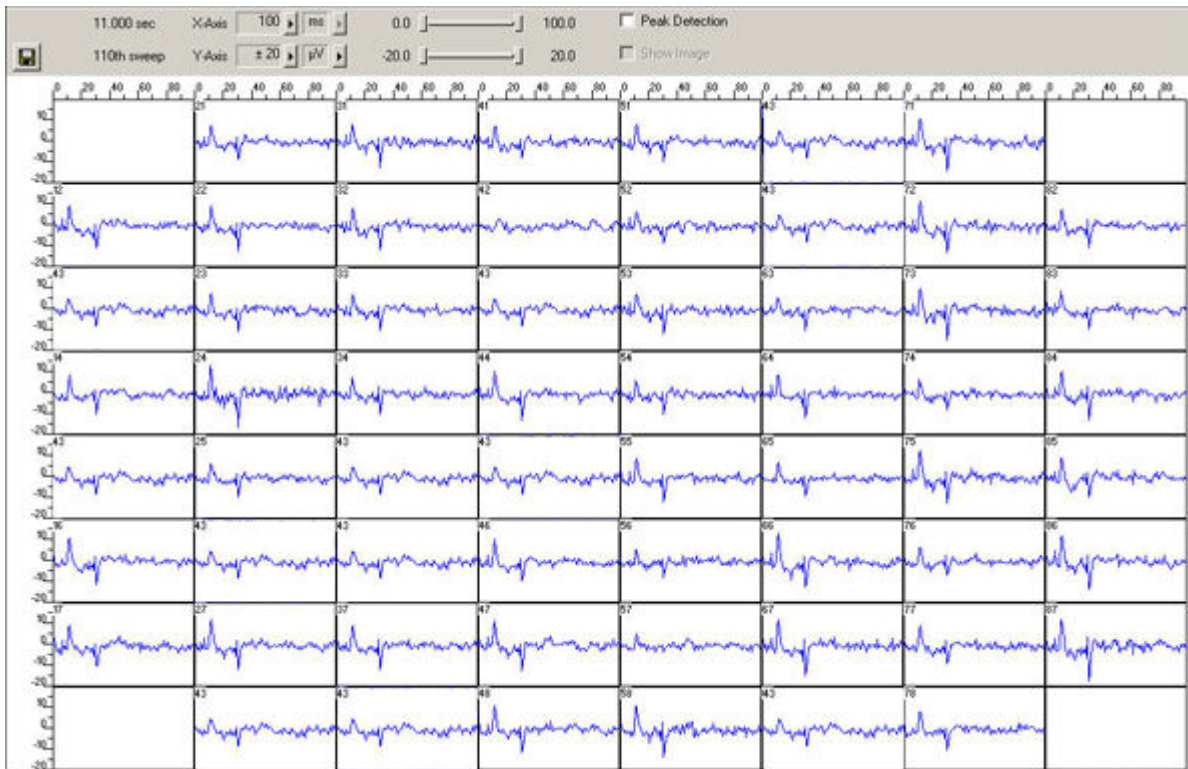

Possible causes:

- ? The cable connecting the amplifier to the power supply, that is, the MCS high grade cable leading from the amplifier to the data acquisition computer if you have a MEA-System, is too long. The applied voltage is not high enough for operating the amplifier.
 - Use a shorter cable, if possible, or try another power supply with a higher output power. MCS high grade cables with a total length of up to 3 m and the isolated power supply IPS10W are recommended for the MEA-System.
- ? You have connected too many amplifiers to your power supply. The isolated power supply IPS10W that is integrated in your data acquisition computer if you use a MEA-System can supply power for up to three standard MEA amplifiers .
 - Use an additional power supply for operating the amplifiers or reduce the number of amplifiers.
- ? The supply power is too low for operating the amplifier. This is especially likely if you use a custom power supply.
 - Contact your local retailer, describe the problem and your hardware configuration, and ask for a power supply that is suitable for your amplifier.

6.5 Liquid Spilled onto Amplifier



Warning: Spilled liquid can damage or even completely destroy the electronics of the MEA amplifier. Avoid it by all means.

Of course it is best to completely avoid this situation and consider the following instructions as an "emergency measurement" only. Even with this measurement, a severe damage to the instrument cannot be excluded. It is very important that the amplifier is **not** connected or used again before repair to avoid further damage caused by corrosion. Even if the initial damage is negligible, the additional damage inflicted by corrosion over a longer period of time can completely destroy the electronics.

1. **Immediately** remove the amplifier from the power supply, that is, unplug the amplifier. Do not connect or use it again before repair.
2. Contact your local retailer and send the amplifier to Multi Channel Systems for cleaning and repair. Multi Channel Systems will check the device and prepare a quote for you, depending on the work and material costs needed for repair.

6.6 Technical Support

Please read the Troubleshooting part of the Manual / Help first. Most problems are caused by minor handling errors. Contact your local retailer immediately if the cause of trouble remains unclear. Please understand that information on your hardware and software configuration is necessary to analyze and finally solve the problem you encounter.

Important: If you need to send the amplifier back to the manufacturer for repair, use only the original case for packaging to avoid further damage inflicted during the shipment.

Please keep information on the following at hand

- **Description** of the **error** and of the context in which the error occurred. Try to remember all steps you had performed immediately before the error occurred. The more information on the actual situation you can provide, the easier it is to track the problem.
- The **serial number** of the device. You will find it on the device.
- Description of the **data acquisition system**.
- The **operating system** and service pack number on the connected **computer**.
- The **hardware configuration** (Isolated Power Supply IPS10W, microprocessor, frequency, main memory, hard disk) of the connected **computer**. This information is especially important if you have modified the computer or installed new hard- or software recently.
- Other connected hardware.

7 Appendix

7.1 Technical Specifications

7.1.1 Pin and MEA Layout

The layout of standard MEA electrodes follows the scheme of a standard grid: The first digit is the column number, and the second digit is the row number. For example, electrode 23 is positioned in the third row of the second column. The numbering follows the standard order from left to right, and from top to bottom.

MEAs are not symmetrical, please pay attention to the recommended orientation of the MEA chip inside the amplifier: The writing NMI should be on the right side.

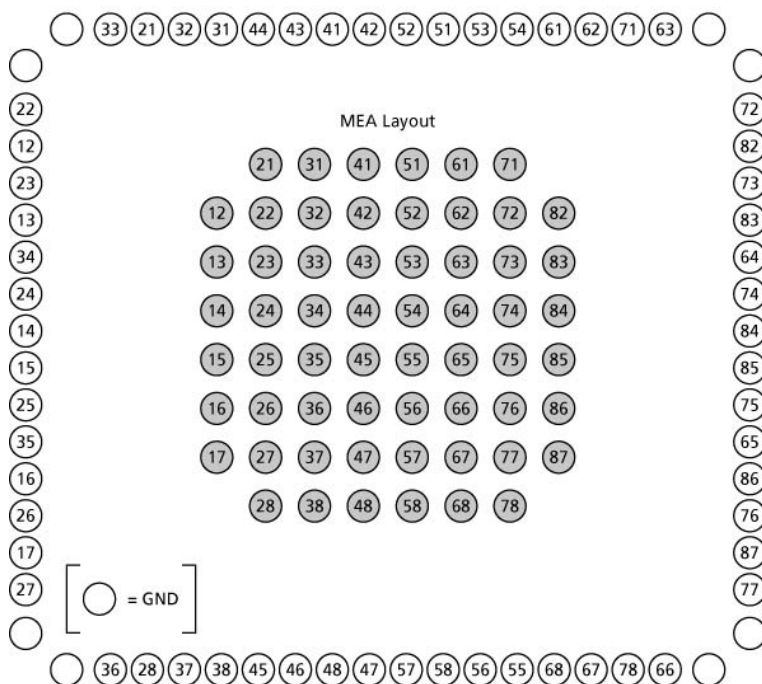

The illustration shows the standard pin layout of the socket on the amplifier. The list below shows the assignment of the electrodes to the pins of the socket. Pin 1 is the ground of the power supply, pin 2 is the ground of the signal, that is, where the signal is referred to. Both pins are already internally connected inside the amplifier.

Channels A1 to A4 are the four additional analog inputs of the MC_Card that are not used by the MEA amplifier. You can access channels A1 to A3 via the BNC sockets labeled Analog IN on the rear side of the data acquisition computer of the MEA-System (see also MEA-System Manual).

MEA Amplifier for Upright Microscopes - Manual

68-Pin MCS standard socket

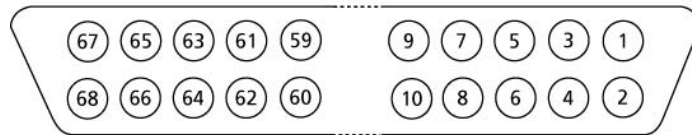

- Pin 1: GNDP (power ground)
- Pin 2: GNDS (signal ground)
- Pin 3-62: Electrode channels, see separate list
- Pin 63-66: Channel A1-A4
- Pin 67: Positive voltage supply
- Pin 68: Negative voltage supply

Assignment pin to electrode			
68-Pin socket pin	MEA electrode	68-Pin socket pin	MEA electrode
3	47	33	52
4	48	34	51
5	46	35	53
6	45	36	54
7	38	37	61
8	37	38	62
9	28	39	71
10	36	40	63
11	27	41	72
12	17	42	82
13	26	43	73
14	16	44	83
15	35	45	64
16	25	46	74
17	15	47	84
18	14	48	85
19	24	49	75
20	34	50	65
21	13	51	86
22	23	52	76
23	12	53	87
24	22	54	77
25	33	55	66
26	21	56	78
27	32	57	67
28	31	58	68
29	44	59	55
30	43	60	56
31	41	61	58
32	42	62	57

7.1.2 MEA1060-Up

Operating temperature	10 °C to 50 °C
Storage temperature	0 °C to 50 °C
Dimensions (W x D x H)	165 mm x 165 mm x 14.5 mm (19 mm with sockets)
Weight	600 g
Supply voltage (external power supply)	± 6 VDC to ± 9 VDC
Supply current	max. 220 mA, typically ± 150 mA
Number of stimulus input channels	60
Maximum recommended stimulus input voltage	± 5 V
Number of analog input channels	60
Input voltage	-4 mV to 4 mV (with respect to the standard gain of 1200)
Input impedance	$10^{11} \Omega$ parallel to 10 pF
Input noise	< 800 nV _{RMS}
Noise density	$e_n = 15nV / \sqrt{Hz}$
Number of analog output channels	60
Output voltage	± 5 V
Output current	10 mA
Output impedance	300 Ω
Bandwidth	1 Hz to 3000 Hz (standard), 1 Hz to 5000 Hz (custom)
Gain	1200 (standard), 500 to 5000 (custom)
Microscope compatibility	Upright microscopes
Distance focal plane to microscope table	8 mm

7.1.3 Heating Element

The heating element is mounted onto the bottom side of the base plate of the MEA1060 amplifier. It is used for keeping the temperature in the MEA culture chamber stable during recordings.

Input voltage	max 10 V
Input current	max 2 A
Temperature sensor	PT 100
Resistance	$15 \pm 2 \Omega$
Heating temperature	Ambient temperature (min 10 °C) to 50 °C
Accuracy	0.1 °C (in the range of 20 °C to 40 °C)
Recovery time	0.5 min to 2 min
Calibration constant	$T = c * (R / R_0) / R_0$ for $c = 259.7 \text{ °C}$
Thermal resistance	6 °C / Watt
Typical time constant	50 s

Pin layout

HE for MEA1060 amplifiers pin layout

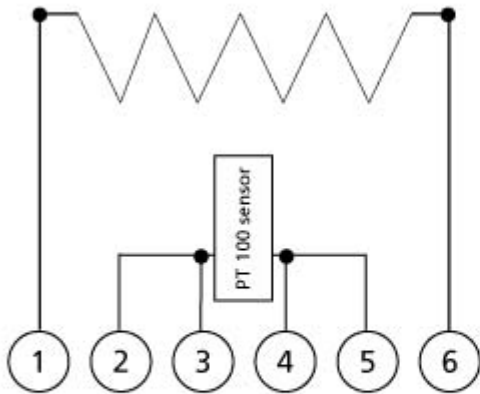

Pin 1, 6: Heating

Pin 2, 5: Temperature sensor supply

Pin 3, 4: Temperature sensor probe

7.1.4 Test Model Probe

The provided test model probe simulates a MEA with a resistor of 220 k Ω and a 1 nF capacitor between bath and electrode, for all 60 electrodes, and can be used for testing MEA amplifiers.

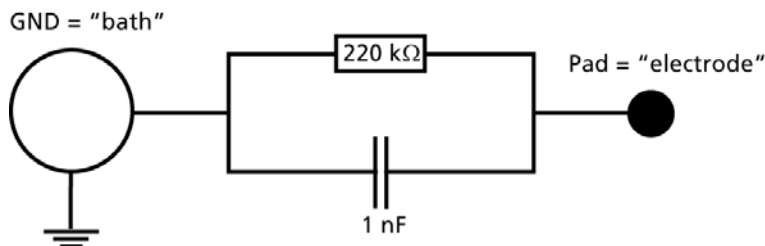

7.2 Contact Information

Local retailer

Please see the list of official MCS distributors on the MCS web site.

User forum

The **Multi Channel Systems User Forum** provides the opportunity for you to exchange your experience or thoughts with other users worldwide.

Mailing list

If you have subscribed to the Mailing List, you will be automatically informed about new software releases, upcoming events, and other news on the product line. You can subscribe to the list on the contact form of the MCS web site.

www.multichannelsystems.com

7.3 Ordering Information

Product information is subject to change without notice. Please contact your local retailer for pricing and ordering information.

MEA amplifiers

Product	Product Number	Description
MEA amplifier for inverted microscopes	MEA1060-Inv	Probe interface and 60 channel pre- and filter amplifier with custom gain and bandwidth.
MEA amplifier for upright microscopes	MEA1060-Up	
MEA amplifier with blanking circuit for inverted microscopes	MEA1060-Inv-BC	Probe interface and 60 channel pre- and filter amplifier with custom gain and bandwidth. The blanking circuit prevents the amplifier from getting saturated and thus prevents stimulus artifacts.
MEA amplifier with blanking circuit for upright microscopes	MEA1060-Up-BC	

USB-MEA-Systems

Product	Product Number	Description
USB-MEA-System for upright microscopes	USB-MEA240-Up-4-System	MEA Workstation for recording and analyzing data from MEA (microelectrode array) experiments. Data acquisition from up to 240 MEA electrodes, 4 analog channels, 1 audio channel, and 16 digital channels. Integrated analog-digital converter board. The digitally converted electrode signals are transmitted to any data acquisition computer via USB 2.0 (High Speed). Complete with 5 MEAs, data acquisition computer with preinstalled software, 4 MEA1060-Up-Standard or MEA1060-Inv-Standard amplifiers for upright or inverted microscopes, 2 temperature controllers, power supply, and accessories.
USB-MEA-System for inverted microscopes	USB-MEA240-Inv-4-System	
USB-MEA-System for upright microscopes with advanced perfusion	USB-MEA240-Up-4-System-E	MEA Workstation for recording and analyzing data from MEA (microelectrode array) experiments. Data acquisition from up to 240 MEA electrodes, 4 analog channels, 1 audio channel, and 16 digital channels. Integrated analog-digital converter board. The digitally converted electrode signals are transmitted to any data acquisition computer via USB 2.0 (High Speed). Complete with 5 MEAs, data acquisition computer with preinstalled software, 4 MEA1060-Inv amplifiers for inverted microscopes or 4 MEA1060-Up amplifiers for upright microscopes, 4 temperature controllers, 4 perfusion cannulas with programmable fluid temperature, power supply, and accessories.
USB-MEA-System for inverted microscopes with advanced perfusion	USB-MEA240-Inv-4-System-E	
USB-MEA-System with blanking circuit for upright microscopes	USB-MEA240-Up-4-BC-System	MEA Workstation for recording and analyzing data from MEA (micro-electrode array) experiments, featuring stimulus artifact suppression (blinking), and software-selectable recording and stimulating electrodes. Data acquisition from up to 240 MEA electrodes, 4 analog channels, 1 audio channel, and 16 digital channels. Integrated analog-digital converter

MEA Amplifier for Upright Microscopes - Manual

USB-MEA-System with blanking circuit for inverted microscopes	USB-MEA240-Inv-4-BC-System	board. The digitally converted electrode signals are transmitted to any data acquisition computer via USB 2.0 (High Speed). Complete with 5 MEAs, data acquisition computer with preinstalled software, 4 MEA1060-Inv-BC or MEA1060-Up-BC amplifiers with blanking circuit for upright and inverted microscopes, 2 temperature controller, power supply, and accessories.
USB-MEA-System with blanking circuit for upright microscopes with advanced perfusion	USB-MEA240-Up-4-BC-System-E	MEA Workstation for recording and analyzing data from MEA (microelectrode array) experiments, featuring stimulus artifact suppression (blanking), and software-selectable recording and stimulating electrodes. Data acquisition from up to 240 MEA electrodes, 4 analog channels, 1 audio channel, and 16 digital channels. Integrated analog-digital converter board. The digitally converted electrode signals are transmitted to any data acquisition computer via USB 2.0 (High Speed). Complete with 5 MEAs, data acquisition computer with preinstalled software, 4 MEA1060-Inv-BC amplifiers with blanking circuit for inverted microscopes or 4 MEA1060-Inv-BC amplifiers with blanking circuit for upright microscopes, 4 temperature controllers, 4 perfusion cannulas with programmable fluid temperature, power supply, and accessories.
USB-MEA-System with blanking circuit for inverted microscopes with advanced perfusion	USB-MEA240-Inv-4-BC-System-E	256-channel recording system with integrated data acquisition from 256MEAs. 252 recording channels, and filter amplification. 4 additional analog and 1 digital I/O port. Complete with data acquisition computer, software package and accessories. USB 2.0 High Speed data transfer with a sampling rate of up to 40 kHz per channel.
USB-MEA256-System with integrated data acquisition and filter amplifier	USB-MEA256-System	256-channel recording system with integrated data acquisition from 256MEAs.252 recording channels, 4 additional analog and 1 digital I/O port. Complete with data acquisition computer, software package and accessories. USB 2.0 High Speed data transfer with a sampling rate of up to 40 kHz per channel, temperature controller and perfusion cannula.
USB-MEA256-System with integrated data acquisition and filter amplifier, and advanced perfusion	USB-MEA256-System-E	32-channel recording system with integrated data acquisition from perforated MEA-32S12-Lx. 32 recording channels, 12 stimulation channels, filter amplification and 4-channel current stimulus generator STG, perfusion cannula PH01 and suction port for low pressure. Complete with data acquisition computer, software package and accessories. USB 2.0 High Speed data transfer with a sampling rate of up to 50 kHz per channel.
USB-MEA32-System with integrated data acquisition, filter amplifier, and stimulus generator	USB-MEA32-STIM4-System	

Accessories

Product	Product Number	Description
Adapter for MEAs with 8 special electrodes for stimulation	MEA-STIM-Adapter	For use with MEAs 200/30-Ti-stim or 200/30-ITO-stim, and MEA1060-Inv amplifier.
Holder with M3 threads	MPM3	For fixing tools with M3 threads next to the MEA
1-Channel temperature controller	TC01	PID based technology, set-point temperature reached fast within 30 s to 5 minutes, control temperature range from ambient temperature to +50 °C
2-Channel temperature controller	TC02	
Perfusion cannula with programmable fluid temperature	PH01	Temperature can be programmed with the temperature controller TC01 or TC02
Signal divider for MEA-Systems	SD-MEA	Placed between a MEA1060 amplifier and MC_Card, permits to select any channel, does not interfere with the data acquisition, for example, for connecting an oscilloscope or other devices to single channels
Test Model Probe for MEA1060 amplifiers	Test-MEA	Test model probe with CB-GND cable (for ground connection). For all MEA1060 amplifiers.
Signal Generator for MEA1060 amplifiers	MEA-SG	Signal generator for MEA-Systems: Can be placed in MEA1060 amplifier. Simulates 12 different types of sine curves and biological signals.
Signal Generator for USB-MEA256-System	256MEA-SG	Signal generator for USB-MEA256-Systems: Can be placed in USB-MEA256 amplifier. Simulates 12 different types of sine curves and biological signals.

MEA Switch

Product	Product Number	Description
MEA Switch for 4 amplifiers	MEAS4/2	The MEA Switch allows you to acquire data from 60 single channels from two MEA1060 amplifiers. If you have a 128-channel MC_Card (MEA 120 System), you can even pick 128 channels in total from two MEA pairs with the MEA Switch for four amplifiers MEAS4/2. The selected channels are combined to one Electrode Raw Data stream that is delivered to MC_Card by a 68-pin MCS high grade Cable.
MEA Switch for 2 amplifiers	MEAS2/1	

Stimulus generators

Product	Product Number	Description
2-Channel stimulus generator	STG4002	General-purpose stimulus generators for current and voltage-driven electrical stimulation, 4000 series, with integrated stimulus isolation unit for each output channel. Operating in Download and Streaming mode (continuous downstreaming of pulses from connected computer). MC_Stimulus II program with advanced features.
4-Channel stimulus generator	STG4004	
8-Channel stimulus generator	STG4008	

MEA Amplifier for Upright Microscopes - Manual

Spare Parts

Product	Product Number	Description
Heating element with 8 mm bore hole	HE-Inv-8	For MEA1060-Inv/MEA1060-Inv-BC amplifier. Available with bore holes in different sizes, for using smaller or larger microscope objectives. The smallest size has the best temperature controlling properties.
Heating element with 12 mm bore hole	HE-Inv-12	
Heating element with 23 mm bore hole	HE-Inv-23	
Heating element	HE-Up	For MEA1060-Up/MEA1060-Up-BC amplifier
Cable assembly	CA	For HE-Inv or HE-Up
0.5 m 68-Pin MCS Standard cable	C68x0.5M	For MEA- or ME-Systems
1 m 68-pin MCS Standard cable	C68x1M	
3 m 68-Pin MCS Standard cable	C68x3M	
Ag/AgCl pellet	P1060-Inv	For MEA1060-Inv/MEA1060-Inv-BC amplifier
Ag/AgCl pellet	P1060-Up	For MEA1060-Up/MEA1060-Up-BC amplifier
Ag wire	W1060-Inv	For MEA1060-Inv/MEA1060-Inv-BC amplifier
Ag wire	W1060-Up	For MEA1060-Up/MEA1060-Up-BC amplifier
Solder lug	SL1060-Inv	For MEA1060-Inv/MEA1060-Inv-BC amplifier
Gold spring contacts	GSC1060-Inv	For MEA1060-Inv/MEA1060-Inv-BC amplifier
Gold spring contacts	GSC1060-Up	For MEA1060-Up/MEA1060-Up-BC amplifier
Gold spring contact comb	GSCC1060-Up	For MEA1060-Up/MEA1060-Up-BC amplifier
3-Pole cable (from STG to MEA1060)	C3P	With ground, not necessary for MEA1060BC amplifiers
Red single pole cable (from STG to MEA1060)	CR	
Black single pole cable (from STG to MEA1060)	CB	

MEA-Systems

Product	Product Number	Description
MEA recording system for inverted microscopes, 60 electrode channels	MEA60-Inv-System	Complete with 5 MEAs, data acquisition computer with MC_Card, MEA1060-Inv amplifier, TC01, power supply, and accessories
MEA recording system for inverted microscopes, 60 electrode channels, 2 MEA amplifiers	MEA60-Inv-2-System	Complete with 5 MEAs, data acquisition computer with MC_Card, 2 x MEA1060-Inv amplifier, MEAS2/1, TC02, power supply, and accessories
MEA recording system for upright microscopes, 60 electrode channels	MEA60-Up-System	Complete with 5 MEAs, data acquisition computer with MC_Card, MEA1060-Up amplifier, TC01, power supply, and accessories
MEA recording system for upright microscopes, 60 electrode channels	MEA60-Up-2-System	Complete with 5 MEAs, data acquisition computer with MC_Card, 2 x MEA1060-Up amplifier, MEAS2/1, TC02, power supply, and accessories
MEA recording system for inverted microscopes with advanced perfusion, 60 electrode channels	MEA60-Inv-System-E	Complete with 5 MEAs, data acquisition computer with MC_Card, MEA1060-Inv amplifier, TC02, PH01, power supply, and accessories
MEA recording system for inverted microscopes with advanced perfusion, 60 electrode channels	MEA60-Inv-2-System-E	Complete with 5 MEAs, data acquisition computer with MC_Card, 2 x MEA1060-Inv amplifier, MEAS2/1, 2 x TC02, 2 x PH01, power supply, and accessories
MEA recording system for upright microscopes with advanced perfusion, 60 electrode channels	MEA60-Up-System-E	Complete with 5 MEAs, data acquisition computer with MC_Card, MEA1060-Up amplifier, TC02, PH01, power supply, and accessories
MEA recording system for upright microscopes with advanced perfusion, 60 electrode channels	MEA60-Up-2-System-E	Complete with 5 MEAs, data acquisition computer with MC_Card, 2 x MEA1060-Up amplifier, 2 x TC02, 2 x PH01, power supply, and accessories
MEA recording system for inverted microscopes, 120 electrode channels	MEA120-Inv-System	Complete with 5 MEAs, data acquisition computer with MC_Card, MEA1060-Inv amplifier, TC02, power supply, and accessories
MEA recording system for inverted microscopes, 120 electrode channels	MEA120-Inv-4-System	Complete with 5 MEAs, data acquisition computer with MC_Card, 4 x MEA1060-Inv amplifier, MEAS4/2, 2 x TC02, power supply, and accessories
MEA recording system for upright microscopes, 120 electrode channels	MEA120-Up-System	Complete with 5 MEAs, data acquisition computer with MC_Card, MEA1060-Up amplifier, TC02, power supply, and accessories
MEA recording system for upright microscopes, 120 electrode channels	MEA120-Up-4-System	Complete with 5 MEAs, data acquisition computer with MC_Card, 4 x MEA1060-Up amplifier, MEAS4/2, 2 x TC02, power supply, and accessories

8 Index

